

## CHAPTER 4 –AUXILIARY POWER UNIT

	Page
<b>TABLE OF CONTENTS</b>	<b>04-00</b>
Table of Contents	04-00-1
<b>INTRODUCTION</b>	<b>04-10</b>
Introduction	04-10-1
<b>POWER PLANT</b>	<b>04-20</b>
APU Power Plant	04-20-1
Engine	04-20-1
Gearbox	04-20-1
<b>SYSTEMS</b>	<b>04-30</b>
Systems	04-30-1
Lubrication	04-30-1
Fuel	04-30-1
Ignition and Starting	04-30-1
Air Intake	04-30-1
<b>CONTROL</b>	<b>04-40</b>
Control	04-40-1
Starting	04-40-1
Stopping	04-40-2
Protective Shutdown	04-40-9
System Circuit Breakers	04-40-10

## LIST OF ILLUSTRATIONS

<b>INTRODUCTION</b>		
Figure 04-10-1	Auxiliary Power Unit Installation	04-10-2
Figure 04-10-2	Auxiliary Power Unit Pneumatic Flow	04-10-3
Figure 04-10-3	Auxiliary Power Unit Indication	04-10-4
<b>SYSTEMS</b>		
Figure 04-30-1	Auxiliary Power Unit Controls and ECU Interface	04-30-2
Figure 04-30-2	Auxiliary Power Unit Door Position Chart	04-30-3
<b>CONTROL</b>		
Figure 04-40-1	Start/Stop Run Controls	04-40-3
Figure 04-40-2	Fuel Synoptic Page	04-40-4



**AUXILIARY POWER UNIT  
Table of Contents**

**Vol. 1**

**04-00-2**

**REV 56, Jan 31/03**

Figure 04-40-3	APU Door and Run Indication	04-40-5
Figure 04-40-4	APU EICAS Messages - Primary Page	04-40-6
Figure 04-40-5	APU EICAS Messages - Status	04-40-7
Figure 04-40-6	APU Start Sequence	04-40-8

	<b>AUXILIARY POWER UNIT Introduction</b>	Vol. 1	04-10-1
		REV 56, Jan 31/03	

## 1. INTRODUCTION

The auxiliary power unit (APU) is installed within a fireproof titanium enclosure in the aft equipment compartment. The APU is a fully automated gas turbine power plant which drives an electrical generator. The generator is rated at 30 kVA and produces 115 VAC electrical power for backup to the main engine generators (refer to Chapter 7). The APU also supplies compressed air to the pneumatic system for main engine starting and environmental control (refer to Chapter 19).

The maximum operating altitude of the APU is 37,000 feet. The maximum altitude for APU starting is 30,000 feet. The maximum altitude for main engine starting using APU bleed air is 13,000 feet. ECS operation using APU bleed air is 15,000 feet.

An Electronic Control Unit (ECU), located in the aft equipment compartment, controls the APU through all phases of operation. The ECU monitors all sensors and switches, sets up the appropriate fuel acceleration schedules and relays specific operating data to the engine indication and crew alerting system (EICAS). The ECU is powered through selection of a PWR/FUEL switchlight on the APU control panel in the flight compartment.

The APU intake door position is continuously shown on the EICAS status page. APU RPM and exhaust gas temperature (EGT) indications are shown on the EICAS status page, only when the APU PWR/FUEL switchlight on the APU control panel is selected.

	<b>Flight Crew Operating Manual CSP A-013</b>	<b>MASTER</b>
--	---	---------------

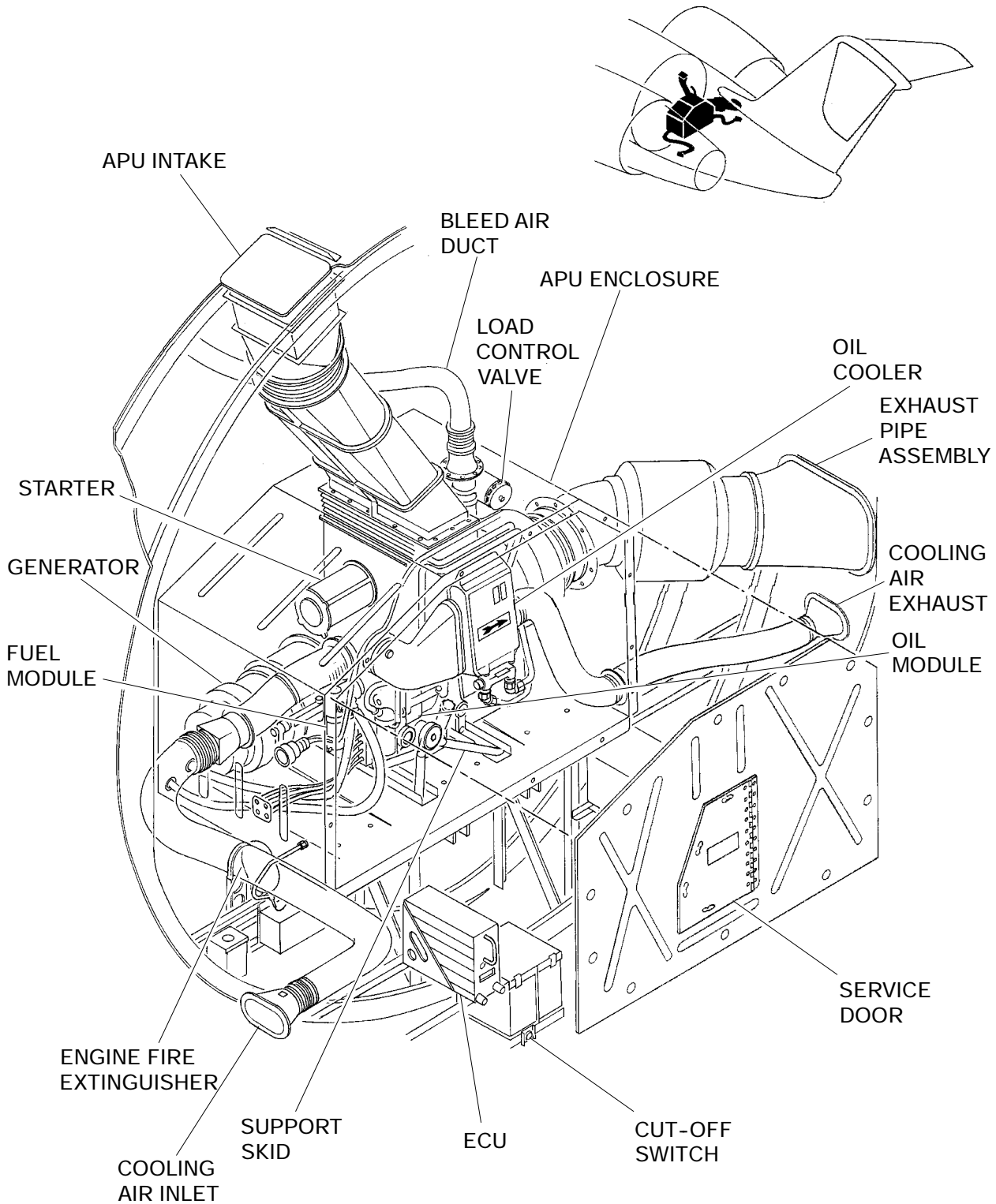

Auxiliary Power Unit Installation  
Figure 04-10-1

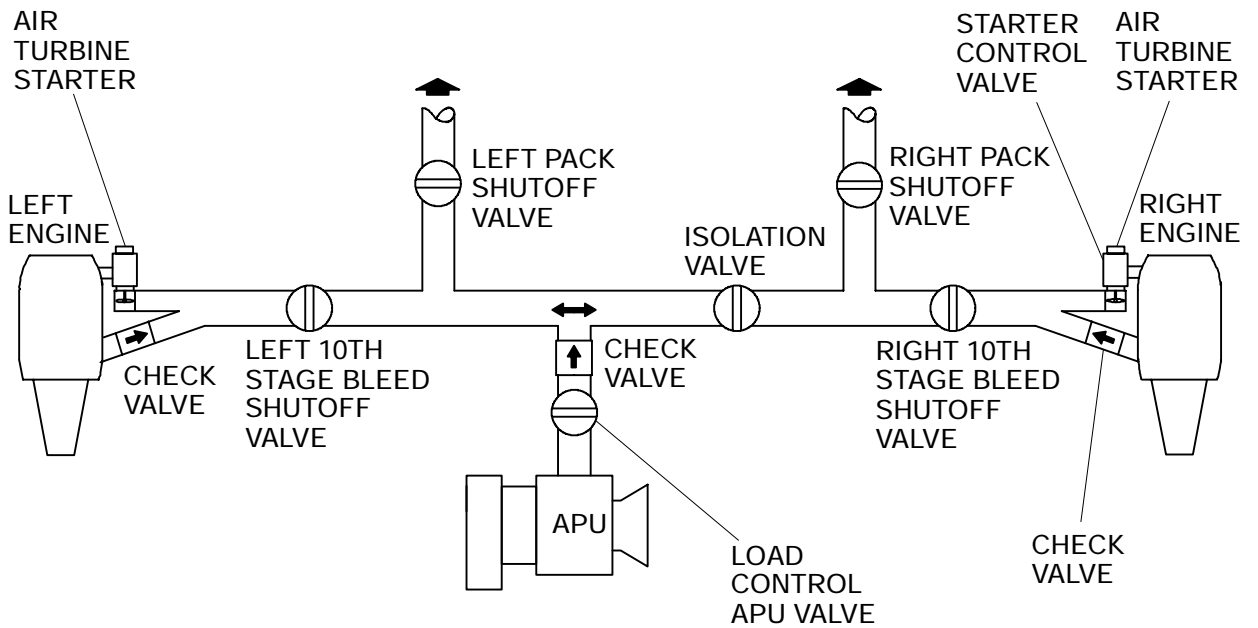
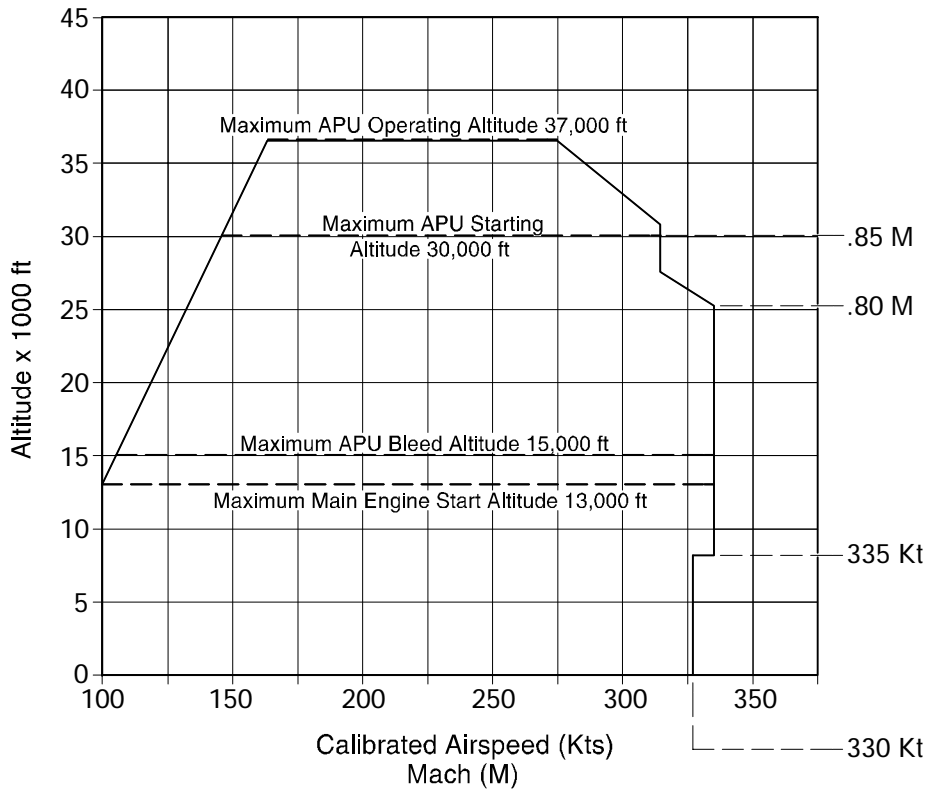

Auxiliary Power Unit Pneumatic Flow  
Figure 04-10-2

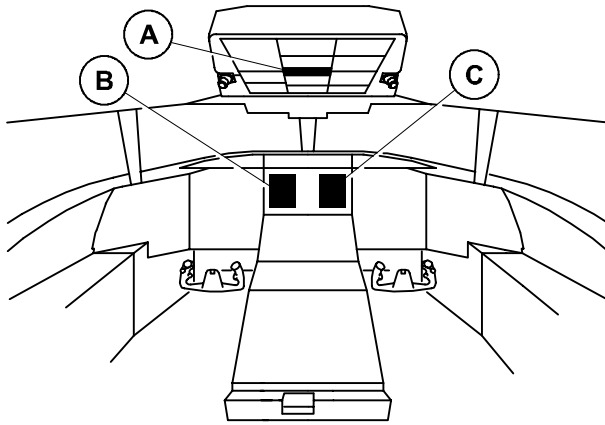

FUEL SHUTOFF VALVE SWITCH/LIGHT

APU START/STOP SWITCH/LIGHT

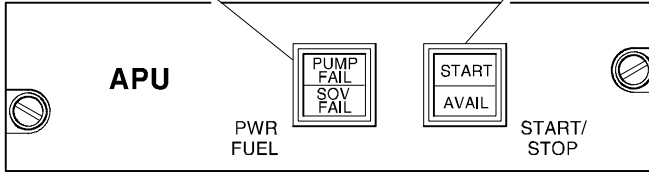

**A** APU Control Panel Overhead Panel



CAUTION MESSAGES

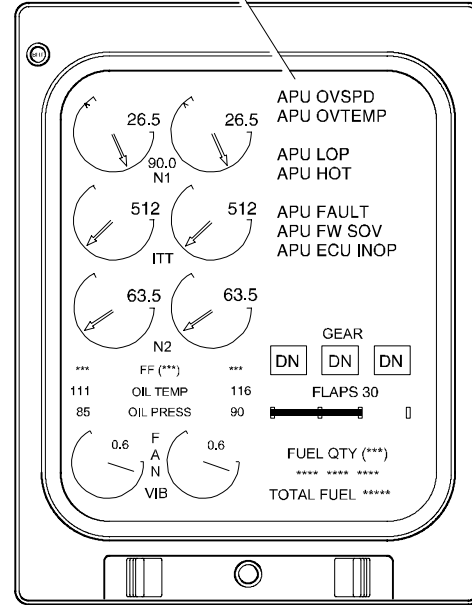

**B** Primary Page

**APU EGT Indicator and Readout**  
Indicates exhaust gas temperature in degrees celcius.

**APU RPM Indicator and Readout**  
Indicates percent of APU rpm.

**APU Inlet Door Status Indicator**  
Indicates DOOR OPEN or DOOR CLOSED or DOOR MID Position.

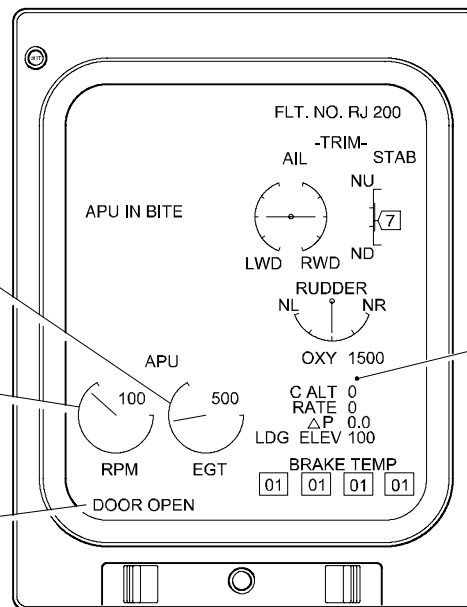

<0039>  
7.2

<0039>  
C TEMP 23°C

**C** Status Page

Auxiliary Power Unit Indication <MST>  
Figure 04-10-3

	<b>AUXILIARY POWER UNIT Power Plant</b>	Vol. 1	04-20-1
		REV 56, Jan 31/03	

## 1. APU POWER PLANT

The APU power plant consists of a gas turbine engine and a gearbox.

### A. Engine

The engine is a single-shaft, constant speed design, consisting of a compressor, a combustor and a two-stage turbine. The compressor draws large volumes of air in through the inlet door on top of the aft fuselage then delivers it under pressure to the combustor. Fuel from both wing tanks is added to the high pressure air and ignited, increasing the energy of the airflow. The high velocity, high temperature gasses are delivered to the turbine section. The turbine converts the high velocity gasses into mechanical energy to drive the compressor and gearbox. The exhaust gases are ducted overboard through the exhaust pipe on the right aft fuselage.

### B. Gearbox

The gearbox reduces the turbine shaft rpm to a speed suitable to operate the gearbox mounted accessories. Accessories include the lubrication module, fuel control unit, electric starter and generator. The gearbox has an integral oil sump. The oil level can be checked using a sight glass on the oil filler assembly.

	<b>Flight Crew Operating Manual CSP A-013</b>	<b>MASTER</b>
--	---	---------------



**AUXILIARY POWER UNIT  
Power Plant**

**Vol. 1**

**04-20-2**

**REV 56, Jan 31/03**

THIS PAGE INTENTIONALLY LEFT BLANK

**Flight Crew Operating Manual  
CSP A-013**

**MASTER**



	<b>AUXILIARY POWER UNIT Systems</b>	Vol. 1	04-30-1
		REV 56, Jan 31/03	

## 1. SYSTEMS

The APU consists of a lubrication system, fuel system, ignition and starting systems, and an air intake and exhaust.

### A. Lubrication

The lubricating system consists of a mechanically driven lubrication module, oil filter, oil cooler, low oil pressure switch, and an oil temperature sensor. The lube module provides pressurized oil to the power plant, gearbox and generator for lubrication and heat removal.

### B. Fuel

Fuel is supplied to the APU fuel control unit from the left and right wing tanks by the XFLOW/APU pump (refer to Chapter 13). The fuel shutoff valve is opened by the ECU at 10% speed. The fuel control unit starts, stops and modulates the flow of fuel to the APU in response to commands from the ECU.

### C. Ignition and Starting

The ignition and starter systems are controlled by the ECU. The ECU commands the DC starter motor to rotate the power plant. The starter accelerates the power plant to a specific speed where the ECU introduces fuel to the combustor. The ignition system is provided to ignite the fuel/air mixture in the combustor which further accelerates the power plant. As the APU accelerates towards the onspeed condition, the starter is disengaged. When the APU reaches normal operating speed the ignition is turned off. At this point the engine becomes self sufficient.

### D. Air Intake

The air inlet door is located in the upper rear fuselage. An actuator, controlled by the ECU positions the door. When open, the door provides ram air for APU operation and the oil cooling. On the ground, the air inlet door has only two positions, open and closed (0 and 42°). In flight, during APU start above 13,000 feet, the ECU limits the door position in response to APU engine rpm and aircraft speed. This prevents excessive amounts of ram air which could cause the APU to flameout. For APU start below 13,000 feet, the door is fully open.

When the APU is not operating, the door remains closed to prevent windmilling of the compressor. The inlet door also serves as a barrier in the event of fire.

	<b>Flight Crew Operating Manual CSP A-013</b>	<b>MASTER</b>
--	---	---------------

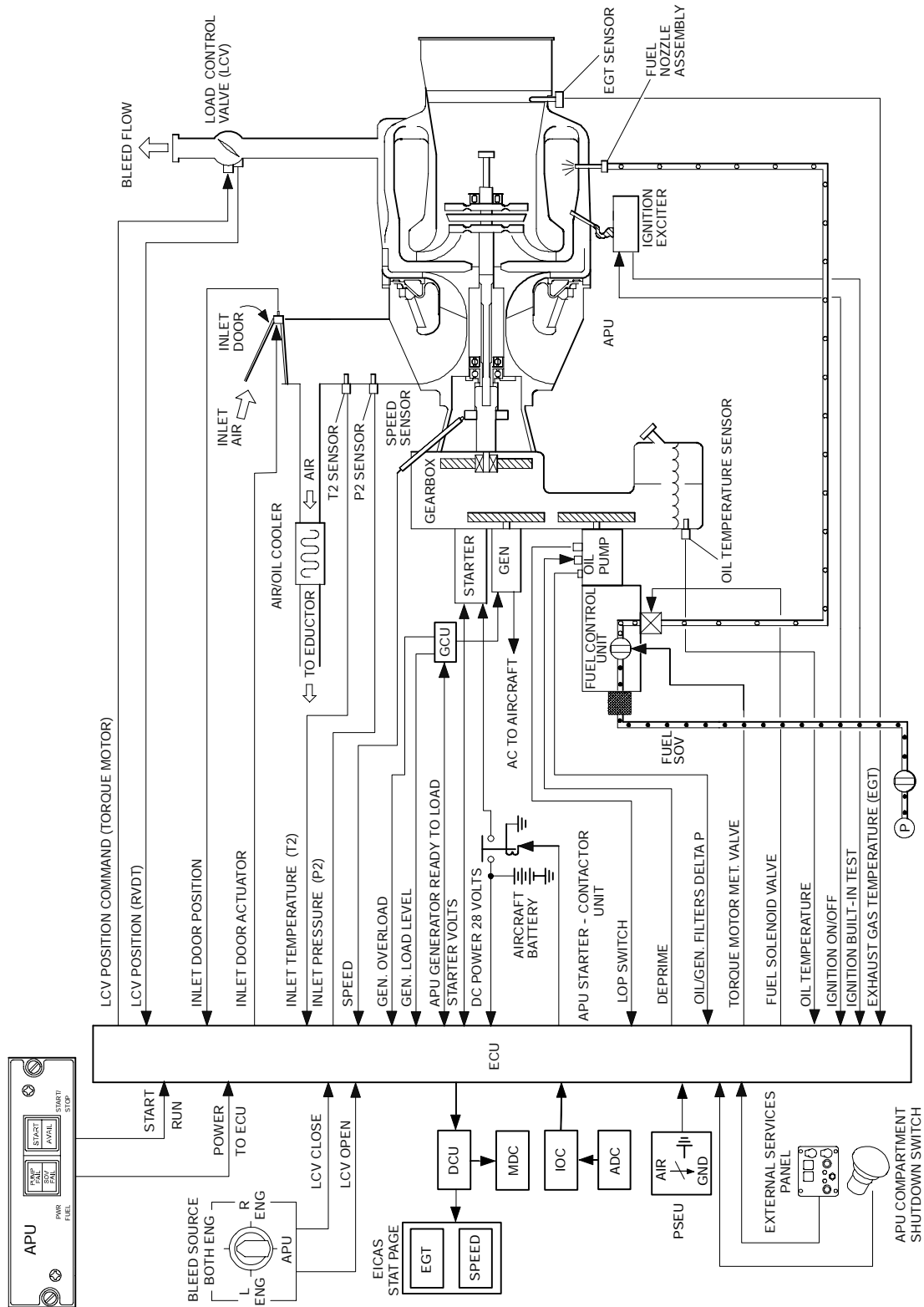

**Auxiliary Power Unit Controls and ECU Interface  
Figure 04-30-1**

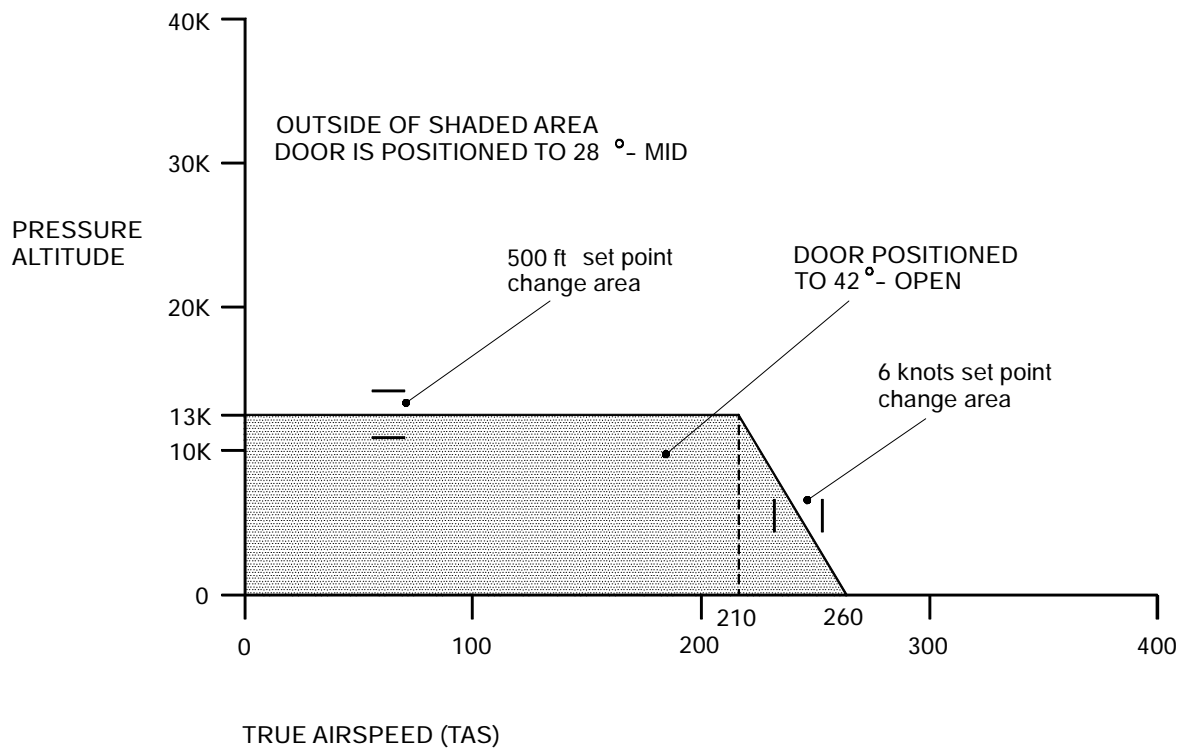

Auxiliary Power Unit Door Position Chart  
Figure 04-30-2



**AUXILIARY POWER UNIT  
Systems**

**Vol. 1**

**04-30-4**

**REV 56, Jan 31/03**

THIS PAGE INTENTIONALLY LEFT BLANK

## 1. CONTROL

The APU electronic control unit (ECU) provides full automatic control of APU starting, stopping, and protects the APU during all modes of operation. The control system ensures that priority is given to electrical loads by reducing bleed airflow.

### A. Starting

When the PWR FUEL switchlight, on the APU panel, is selected:

- The ECU is powered
- The air inlet door opens (position is displayed on the EICAS status page)
- The APU RPM and EGT gauges are displayed on the EICAS status page
- The fuel pump comes on.

When the START/STOP switchlight, on the APU control panel, is selected:

- The ignition is activated
- The starter motor is energized
- The fuel shutoff valve opens
- The START legend on the APU panel comes on
- The APU START status message is displayed.

The starter motor is deactivated at 50% rpm and the START legend goes out. When the APU reaches 99% rpm, ignition is turned off and two seconds later the AVAIL legend, in the START/STOP switchlight, illuminates to notify the crew that the APU is ready to supply electrical power and bleed air.

#### (1) APU Starter Limits

SOURCE	START # and TIME ON	COOLING TIME
Battery	1 30 seconds	No cooling required
	2 30 seconds	20 minutes
	3 30 seconds	No cooling required
	4 30 seconds	40 minutes
External DC Power	1 15 seconds	No cooling required
	2 15 seconds	20 minutes
	3 15 seconds	No cooling required
	4 15 seconds	40 minutes



**AUXILIARY POWER UNIT  
Control**

Vol. 1

04-40-2

REV 56, Jan 31/03

**NOTE**

It is recommended that a 2 minute delay be observed between start attempts to allow for cooling of the APU start contactor and for fuel drainage.

Effectivity:

- Airplanes 7003 to 7100 not incorporating Service Bulletin 601R-28-008

**NOTE**

During normal operations, a nuisance XFLOW/APU PUMP caution message may come on. When this occurs, selecting the APU PWR/FUEL switchlight to on then off will usually clear the message. If the message clears, there is no operational restrictions and the anomaly should be disregarded.

**B. Stopping**

To shutdown the APU, the crew deselects the START/STOP switchlight on the APU panel. The APU will automatically shed its loading and shutdown. The PWR/FUEL switch is deselected to close the fuel shutoff valve and to remove primary electrical power to the ECU.

In the event of an emergency, the flight crew can press the APU FIRE PUSH switchlight on the glareshield. On the ground, the APU can be shut down by pushing an APU emergency stop button located in the aft equipment compartment or by selecting the APU shut-off (cover-guarded) switch on the external services panel on the RH forward fuselage. Either selection sends a signal to the ECU to carry out an immediate shutdown.

**NOTE**

If overspeed or overtemperature occurs during flight, do not restart the APU.

**PWR FUEL Switch/Light**

When pressed in, crossflow/APU pump is energized, APU IN BITE, APU gauges energized, door scheduled to open and APU fuel shut-off valve opens.

- PUMP FAIL light comes on to indicate that crossflow/APU pump has failed.
- SOV FAIL light comes on to indicate that the APU fuel feed SOV has failed.

**APU START/STOP Switch/Light**

When pressed in, starter motor is energized and START light (amber) comes on.

- At 50% rpm, START light goes out.
- At 95% rpm, and 4 seconds later, AVAIL light (green) comes on.

When pressed out:

- FCU shut-off valve closes.
- APU shuts down, and
- AVAIL light goes out.

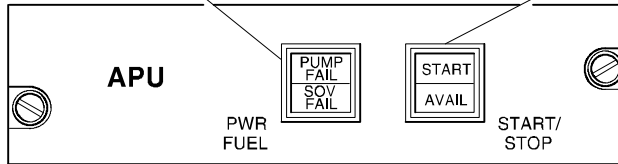

**A** APU Control Panel Overhead Panel

**APU SHUT-OFF Switch**

Used by maintenance personnel to shut down the APU during ground servicing.

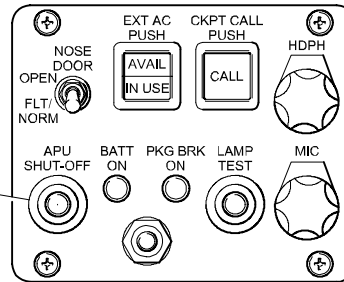

External Service Panel Right Forward Fuselage

**APU EMER STOP Switch**

Used by maintenance personnel to shut down the APU during ground servicing.

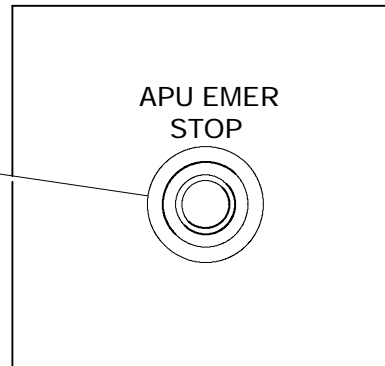

AFT Equipment Bay (Below APU)

Start/Stop Run Controls  
Figure 04-40-1

**NOTE**

APU fuel pump automatically comes on when PWR FUEL switch/light pressed in.





**APU Pump Fuel Feed LH, RH**

- Green - At least 10 pounds in respective tank.

**APU Pump Manifold**

- Manifold fuel lines come on:
- Green - APU pump on.
  - Amber - APU pump failed.





**APU Fuel Feed Shut Off Valve Position Indicator**

-  open (white)
-  closed (white)
-  failed (amber)
-  or  input data invalid (half-intensity magenta)

**APU Fuel Pump Symbol**

-  symbol comes on:
- White - Pump is off.
  - Green - Pump is on.
  - Amber - Pump failed.
  - Half-Intensity  
Magenta - Invalid data

**Cross Flow Shut Off Valve LH, RH Position Indicator**

-  open (white)
-  closed (white)
-  failed (amber)
-  or  input data invalid (half-intensity magenta)

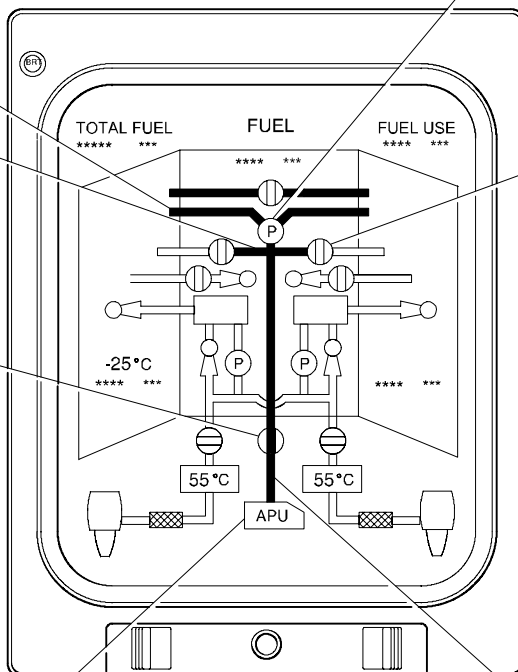

**Fuel Synoptic Page**

**APU Symbol**

- White - APU not running
- Half-Intensity Cyan - APU ready to load
- Half-Intensity Magenta - Invalid data

**APU Fuel Feed**

- Green - Normal flow.
- Amber - Restricted flow (SOV, pump or fuel filter).
- Red - Fire at APU with SOV failed open or at mid-position.

Fuel Synoptic Page <MST>  
Figure 04-40-2



**APU Inlet Door Status  
Indicator (white)**

Indicates air intake door position:

- DOOR CLSD
- DOOR MID
- DOOR OPEN
- DOOR INHIB/CLSD
- DOOR INHIB/MID
- DOOR INHIB/OPEN
- DOOR - - - (amber dashes)

If door position is unknown:  
DOOR (with amber dashes - - )

If the APU is inhibited and the  
door position sensor fails, EICAS  
will indicate DOOR INHIB - -  
message.

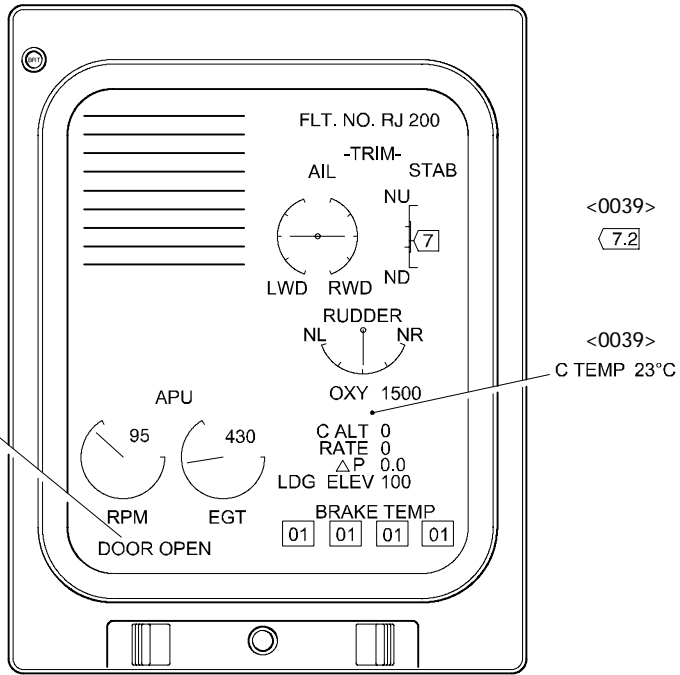

**Status Page**

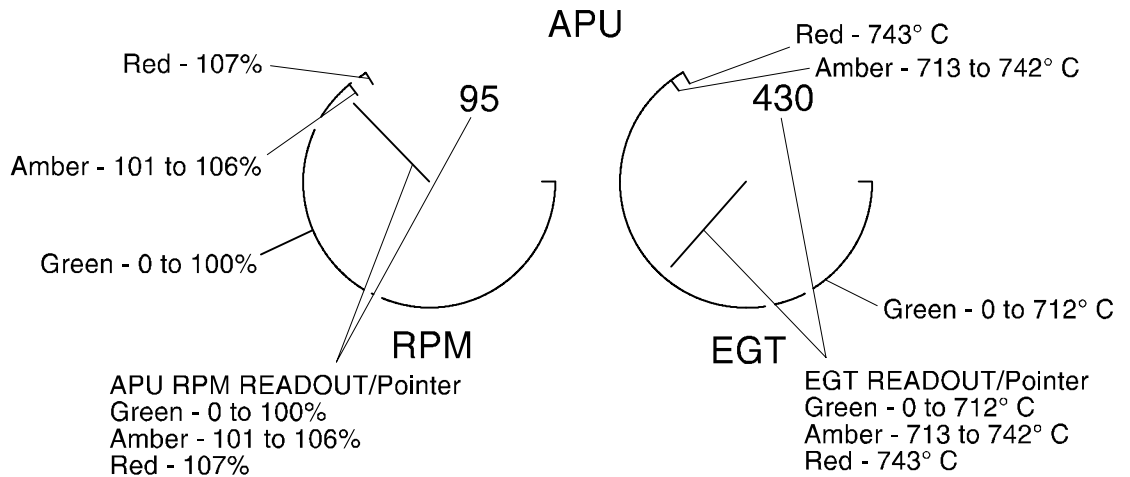

The APU gauges come on when the electronic control unit is powered (APU PWR FUEL switch/light pressed in).

With the ECU powered, gauge information is maintained during shutdown.

The APU gauges go off when the electronic control unit is not powered (APU PWR FUEL switch/light pressed out).

**NOTE**  
The gauges will remain in view for approximately 60 seconds, after PWR FUEL switch/light pressed out.

APU Door and Run Indication <MST>  
Figure 04-40-3

**APU OVERTEMP warning (red)**  
EGT is greater than 743° C with APU RPM greater than 87 % or greater than 974° C at all times. APU shuts down automatically (on ground).



**APU OVERSPEED warning (red)**  
APU is running greater than 107 % rpm. APU shuts down automatically.

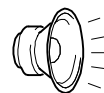

**APU OIL PRESS**

APU has low oil pressure. APU shuts down automatically. (On ground only).

**APU OIL TEMP**

APU has high oil temperature (325° C). APU shuts down automatically. (On ground only).

**APU FAULT**

Loss of APU control circuits (microprocessor, thermocouple or speed signal). APU shuts down automatically.

**APU SOV FAIL**

APU Fuel Feed SOV not in a confirmed position (either open or closed).

**APU SOV OPEN**

APU Fuel Feed SOV is open 10 seconds after an APU fire condition. APU FUEL SOV light, on APU panel, comes on (amber).

**APU LCV FAIL**

Load control valve has failed (either open or closed).

**APU BLEED ON**

Load control valve is open and barometric altitude is greater than 15,000 feet.

**X-FLOW/APU PUMP caution (amber)**

Comes on to indicate that X-flow/APU pump has failed (low pressure). Accompanied by XFER/APU PUMP switch/light indicating FAIL.

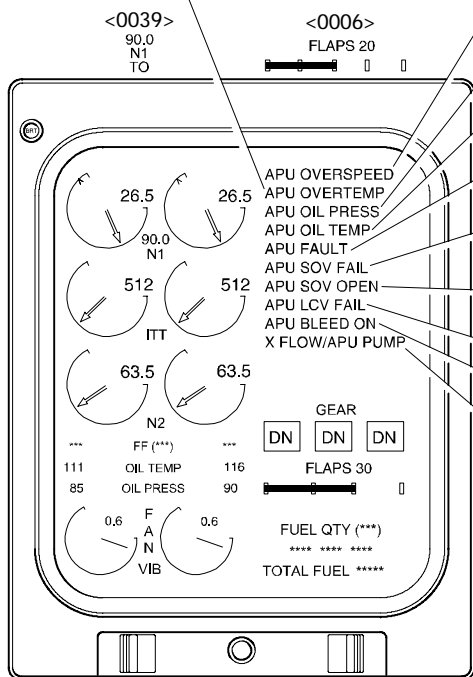

**Primary Page**

APU EICAS Messages – Primary Page <MST>  
Figure 04-40-4

**APU SOV CLSD advisory (green)**  
APU fuel feed SOV is closed during an APU fire condition.

**APU IN BITE status (white)**  
Electronic control unit is running diagnostics (prior to start), for approximately 5 seconds.

**APU START status (white)**  
APU start in progress.

**APU ECU FAIL status (white)**  
Electronic control unit has failed. APU fuel feed SOV is confirmed open.

**APU LCV OPEN status (white)**  
APU load control valve is open. 10th stage, APU LCV OPEN switch/light comes on.

**APU SOV OPEN status (white)**  
APU fuel feed SOV is open with the APU not ready and no APU fire detected.

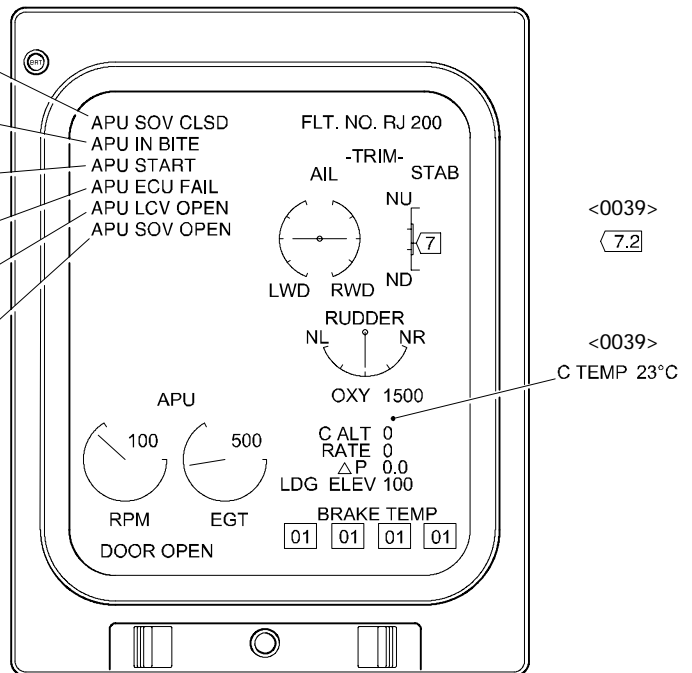

**Status Page**

**APU EICAS Messages – Status <MST>  
Figure 04-40-5**

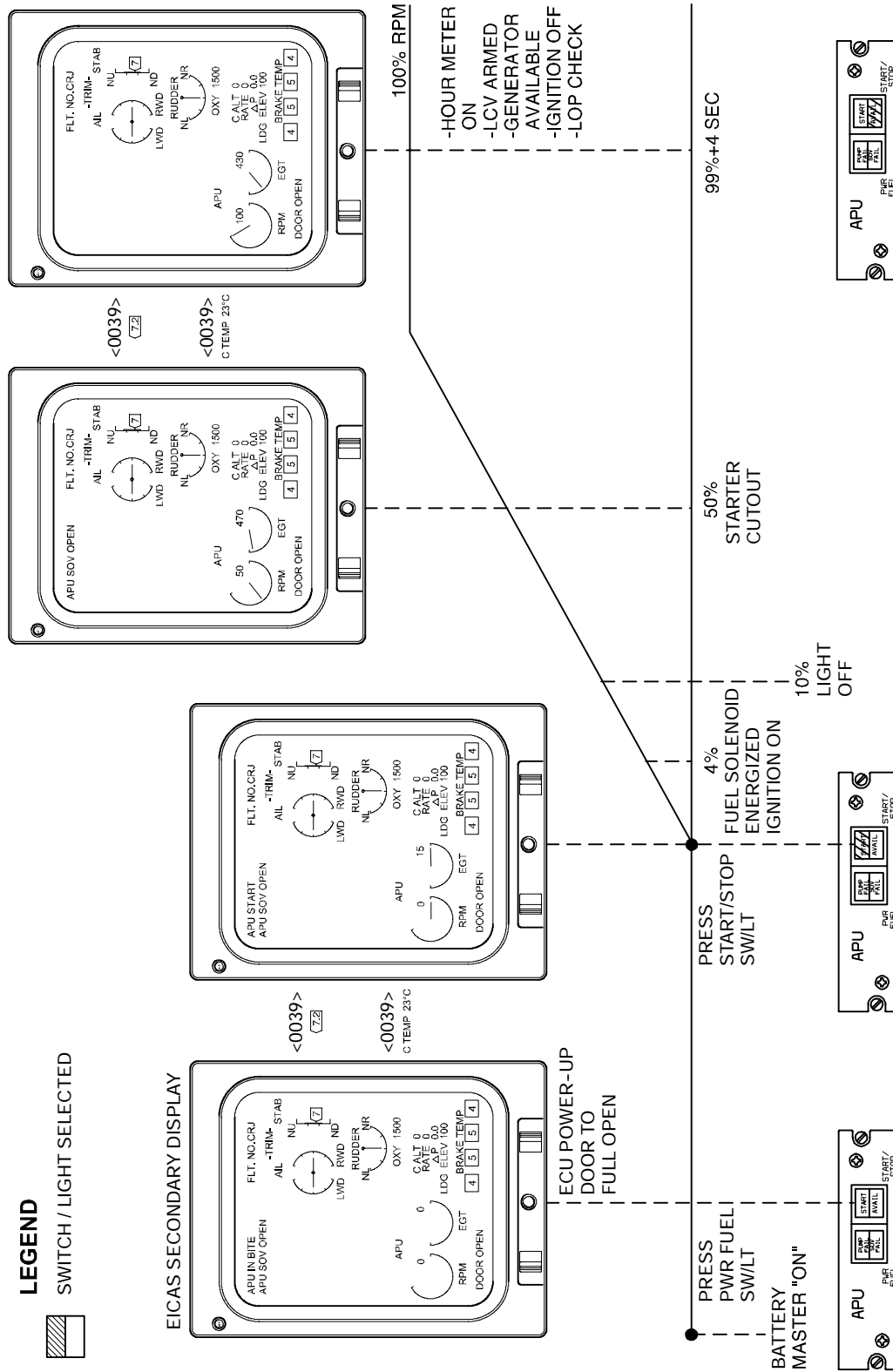

APU Start Sequence <MST>  
Figure 04-40-6

	<b>AUXILIARY POWER UNIT Control</b>	Vol. 1	04-40-9
		REV 56, Jan 31/03	

### C. Protective Shutdown

The ECU will shut down the APU (on the ground) if any of the following faults occur:

- Overtemperature - APU EGT exceeded schedule limits
- Low oil pressure (LOP) - Low oil pressure exists for 15 seconds with the APU operating
- High oil temperature - Oil temperature exceeded 325°C (617°F) with the APU operating
- Overspeed - APU speed exceeded 107 percent
- DC power loss - Battery power lost
- Loss of EGT signal - EGT sensor failure
- Loss of speed signal - Speed sensor failure
- Overcurrent - Fuel torque motor failure
- Door position - Door not in commanded position
- ECU failure - Internal ECU failure
- Slow start - Starter time period exceeded
- Emergency fire shutdown - APU FIRE PUSH or one the two external stop switches have been activated
- Starter relay - No rotation.

All the above protective shutdowns are inhibited in flight mode by a weight-off-wheels signal from the PSEU, except for the following 5 failures:

- Overspeed
- DC power loss
- ECU failure
- Loss of speed signal
- Emergency fire shutdown.

	<b>Flight Crew Operating Manual CSP A-013</b>	<b>MASTER</b>
--	---	---------------



**AUXILIARY POWER UNIT  
Control**

Vol. 1      04-40-10

REV 56, Jan 31/03

**D. System Circuit Breakers**

SYSTEM	SUB-SYSTEM	CB NAME	BUS BAR	CB PANEL	CB LOCATION	NOTES
Auxiliary Power Unit	APU Controls	APU BAT CONT	APU BAT DIR	5	B2	
		APU ACT	MAIN BAT DIR		A3	
	APU Electronic Control Unit	APU ECU	DC BAT	1	N12	
	Battery Charging	APU CHARGER	AC UTIL 2	2	E5	
	Fire Extinguishing	APU FIRE EXT	DC EMERG BUS	1	R5-6	