

Challenger Global 300 - Electrical

INTRODUCTION

Primary DC electrical power is provided by two engine-driven generators and one APU-driven generator supplying 28 volt power to a split bus electrical system. An automatic electrical load-shedding system prevents generator overload and prolongs battery duration during a single or dual generator failure. Two main batteries power essential avionics, communication, and instrumentation. A separate battery powers the independent standby instrument system. An optional hydraulically driven electrical generator is available to provide electrical power generation in the event all engine and APU generator power is lost.

A ground power unit can be connected to the aircraft to provide electrical power if desired.

The only AC electrical power requirements are for passenger convenience. This power is provided by inverters located in the aft accessory compartment.

The electrical system incorporates a split, multiple bus system for power distribution interconnected by contactors, fuses, and circuit breakers. These react automatically to isolate a malfunctioning circuit.

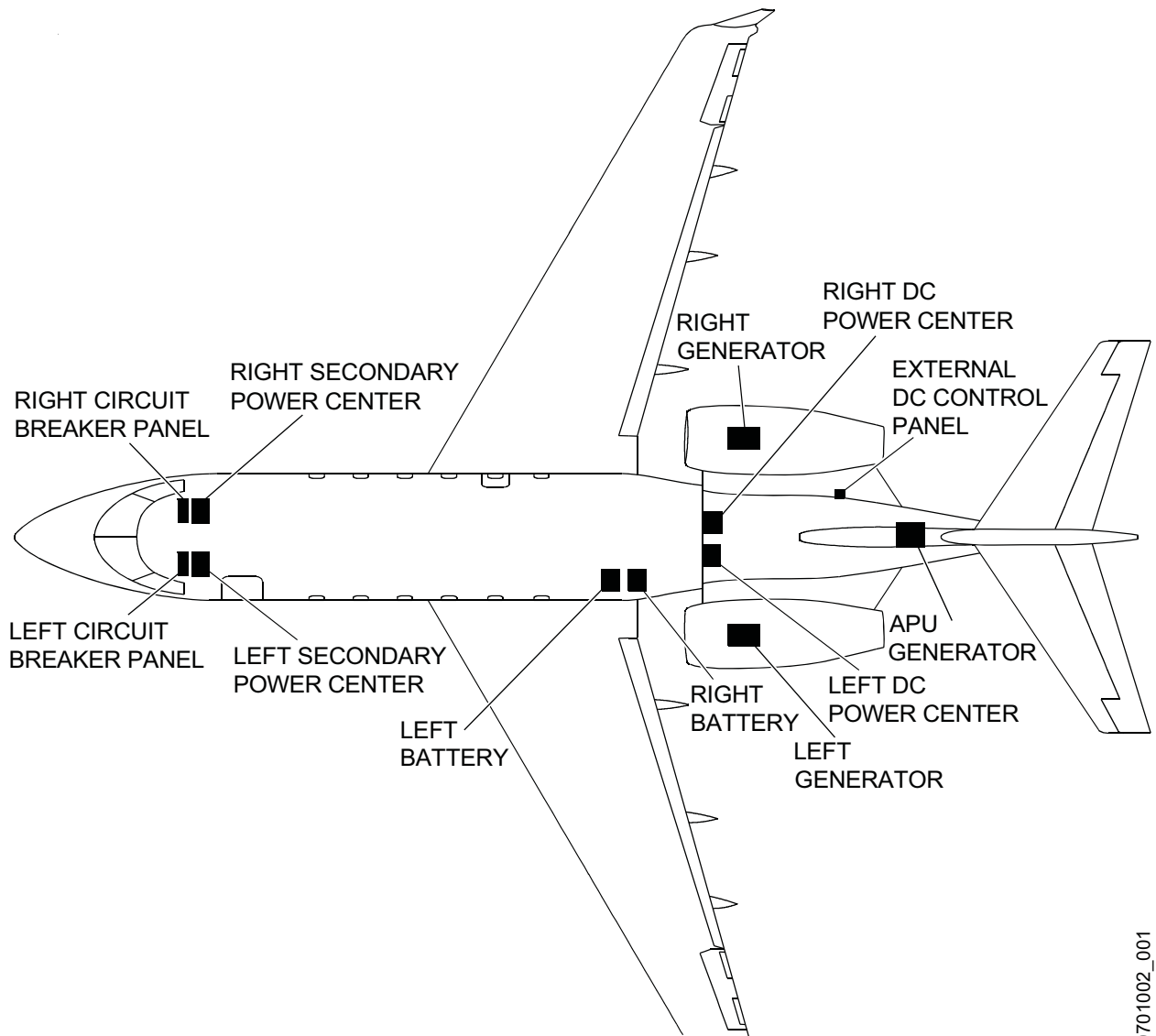

CFO0701002_001

Challenger Global 300 - Electrical

ELECTRICAL SYSTEM

DESCRIPTION

The Challenger 300 electrical system is a 28 vdc system and divided into two main functions:

- Power generation system
- Power distribution system

The electrical power generation system consists of the following power sources:

- Two main generators provide electrical energy to feed the loads under normal operation in flight and ground operations. Either one of the engines provides sufficient generator power for normal operations
- One APU generator can share electrical loads with the engine generators at medium and low altitudes or provide enough electrical generation capability to replace one or both engine generators during failure conditions
- Two onboard batteries that feed the essential loads under emergency conditions when the generators are inoperative, and on the ground for feeding all loads
- One standby instrument battery located in the nose landing gear bay area. It provides power to the standby instrument system for approximately 5 hours when fully charged
- One optional hydraulic motor driven generator with a non-time limited source of electrical power in the event total generated power is lost
- Additionally, an external DC power source for ground operation

The electrical power distribution system consists of four distribution boxes:

- Two of the four electrical distribution boxes are direct current power centers (DCPC). These are located in the aft equipment bay of the aircraft. They are fed by the power sources listed above and their function is to switch electrical power to the distribution buses and then distribute this power to loads in the aft fuselage of the aircraft
- The other two electrical distribution boxes are secondary power centers. They are located in the equipment rack in the front fuselage of the aircraft and are fed by the distribution buses of the DCPCs. They distribute electrical power to the loads in the front fuselage of the aircraft
- Two circuit breaker panels are located in the cockpit. They are fed by the distribution buses of the secondary distribution centers and distribute electrical power to loads which require pilot access to the associated circuit breaker.
- The electrical system is electrically and physically segregated into two channels. External DC power and the APU generator are arranged to connect to these two channels

COMPONENTS AND OPERATION

ENGINE AND APU GENERATORS

Two engine driven generators, one on each engine accessory section, provide the normal source of 28 volt power to the airplane. A third identical generator is installed on the APU. All three generators are air cooled and include an integrated fan. The engine-driven generators automatically come online after the engines are running, the GPU is disconnected, and the EXT PWR switch on the electrical control panel is depressed, changing the annunciation from ON to AVAIL. The generators are limited to 12 kVA (400 amp) and the nominal output voltage is 29.5 volts.

When at least two generators are online, the bus tie is normally open. The left generator recharges the left main battery, and the right generator recharges the right main battery. The generators supply DC power to all DC powered equipment on the airplane under normal conditions.

EXTERNAL POWER

Ground power can be connected to the airplane through a receptacle located on the lower right side of the fuselage just below the engine pylon. The anti-flash contactor that connects the output of the GPU to the aircraft electrical system closes only if the voltage and polarity are within acceptable limits. The acceptable voltage limits are approximately 24 to 32 volts. The GPU should be regulated to 28 vdc and limited to 1500 amps.

The EXT PWR switch is located on the cockpit electrical control panel. The green AVAIL caption on the EXT PWR switch illuminates if the GPU is within acceptable parameters. Depressing the EXT PWR switch when the green AVAIL light is illuminated closes the GPU antifeash contactor, connecting the GPU. The ON caption illuminates, and the green AVAIL caption extinguishes. The GPU may be deselected with the same switch.

The bus tie contactor automatically closes when a GPU is connected and selected ON. The entire DC system is powered, assuming the EXT PWR is selected ON.

Challenger Global 300 - Electrical

ELECTRICAL SYSTEM (Cont)

EXTERNAL POWER (Cont)

Neither the engine-driven nor the APU-driven generators come online with the GPU selected ON. If they are on when the GPU is selected, they drop offline. Engine-driven generators automatically come online after engine start, but not if the GPU is selected ON. The aircraft main batteries do not have to be on to close the GPU antiflash contactor.

GPU output voltage is indicated on the SUMMARY page and on the ELECTRICAL system synoptic display. No indication of amps drawn from the GPU is provided.

With the external power cable connected, the following indications are annunciated on the ELECTRICAL synoptic display. EXT PWR symbol and line are white when AVAIL, green when selected on, and removed when disconnected. These appear whenever a GPU cable is connected to the airplane, and a voltage of greater than 5 vdc is sensed by the power monitor.

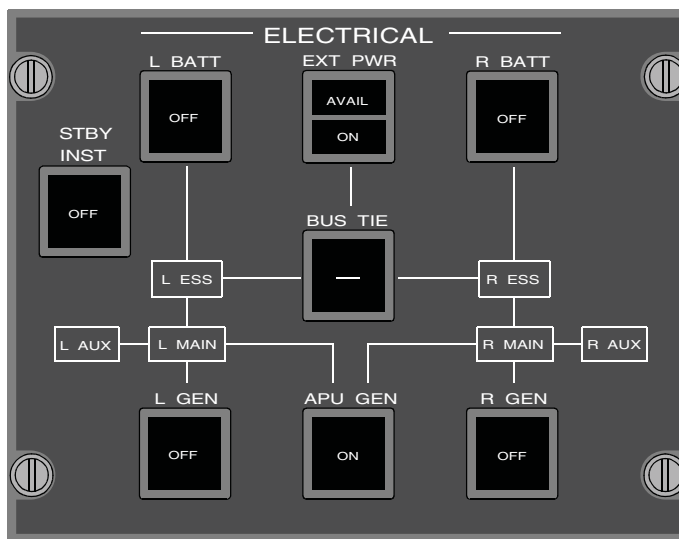

Electrical panel shown with the optional Hydraulic Motor Driven Generator (HMDG) system.

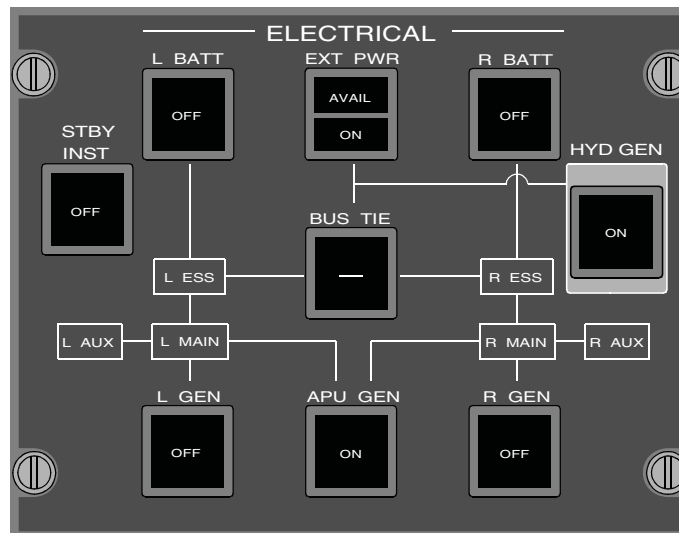

Challenger Global 300 - Electrical

ELECTRICAL SYSTEM (Cont)

BATTERIES

The batteries are located in the fuselage fairing aft of the left wing. During APU start, the right battery is isolated from the rest of the aircraft and provides power to the APU starter. The bus tie closes and the left battery provides power to the rest of the aircraft for emergency operation during total generator failure. They also provide power to the battery buses even when the batteries are selected off.

The standard batteries are 24 volt nickel-cadmium (NICAD) rated at 44-amp hr.

Gases produced by the main batteries are vented overboard through two tubes that extend from the battery cases.

The batteries are connected to the essential buses when the contactors are closed. When a generator is online, it is connected to the main buses and charges the battery.

When the batteries are connected on their corresponding buses in parallel with the generators, they are charged by the generators.

Individual battery voltages and temperatures can be read on the ELECTRICAL and SUMMARY synoptic displays on the MFD.

During a total generator failure, the aircraft batteries provide power for necessary essential equipment for a limited duration.

Standby Instrument power is supplied by a dedicated 24 vdc battery. The standby instrument is activated by a separate STBY INST switch located on the ELECTRICAL power panel.

If the batteries are allowed to significantly discharge prior to bringing a generator on-line, the charging current may be large enough to result in a APU GEN OVERLOAD, or L (R) GEN OVERLOAD caution CAS message for a short time as the batteries recharge.

POWER CENTERS

The two DC power centers (left and right) provide the following functions:

- Protect the loads from abnormal electrical power quality
- Control and reconfigure the distribution system in response to manual switching or when a fault occurs. This reconfiguration shall ensure the supply of the buses in accordance with an established priority relating to the power sources available
- Ensure the coupling of the two channels on the ground when only batteries or external DC power are available, or in flight when only one generator is available
- Control the automatic load shedding
- Isolate the faulted distribution buses when a short circuit occurs on a feeder or on a bus
- Distribute the electrical power to loads located in the aft of the aircraft
- Distribute the electrical power to secondary power centers located in the front fuselage of the aircraft
- Protect distribution cables from short circuit

Additionally, there is an Auxiliary Power Center for the APU Generator.

ELECTRICAL SYSTEM (Cont)

SECONDARY POWER CENTERS

The secondary power centers are located on the equipment rack in the front fuselage of the aircraft. They are fed by the distribution buses of the direct current power centers and distribute electrical power to the loads in the front fuselage of the aircraft.

HYDRAULIC MOTOR DRIVEN GENERATOR (HMDG) (OPTIONAL)

The optional HMDG system provides a non-time limited source of electrical power in the event total generated power is lost. The HMDG is powered by the left hydraulic system. It is rated for 65 amp and consists of a hydraulic motor that drives a DC generator. An ELEC HYD GEN ON (S) message will be displayed on the EICAS when the system is activated.

The HMDG is operated by the HYD GEN switch on the ELECTRICAL cockpit control panel.

CIRCUIT BREAKER PANELS

Two circuit breaker panels are located in the cockpit and are fed by the distribution buses of the secondary power centers. They distribute power to the loads which require pilot access to the associated circuit breaker.

Two other circuit breaker panels are located in the left and right equipment racks. They are also fed by the distribution buses of the secondary power centers.

COCKPIT FLOOR HEATERS

Four cockpit floor heaters are installed on the flight compartment floor, one on each side of the two control columns. Each is covered by a scuff plate to prevent damage to the heat strips. There are no pilot operated controls, as a temperature limiting circuit keeps the temperature between 68 °F (20 °C) and 95 °F (35 °C). Also an internal thermal switch prevents the floor heaters from an overheat condition.

The pilot's floor heater is connected to the left equipment rack circuit breaker panel, and the copilot's floor heater is connected to the right equipment rack circuit breaker panel.

Challenger Global 300 - Electrical

CB1 PILOT CIRCUIT BREAKER PANEL (TYPICAL)

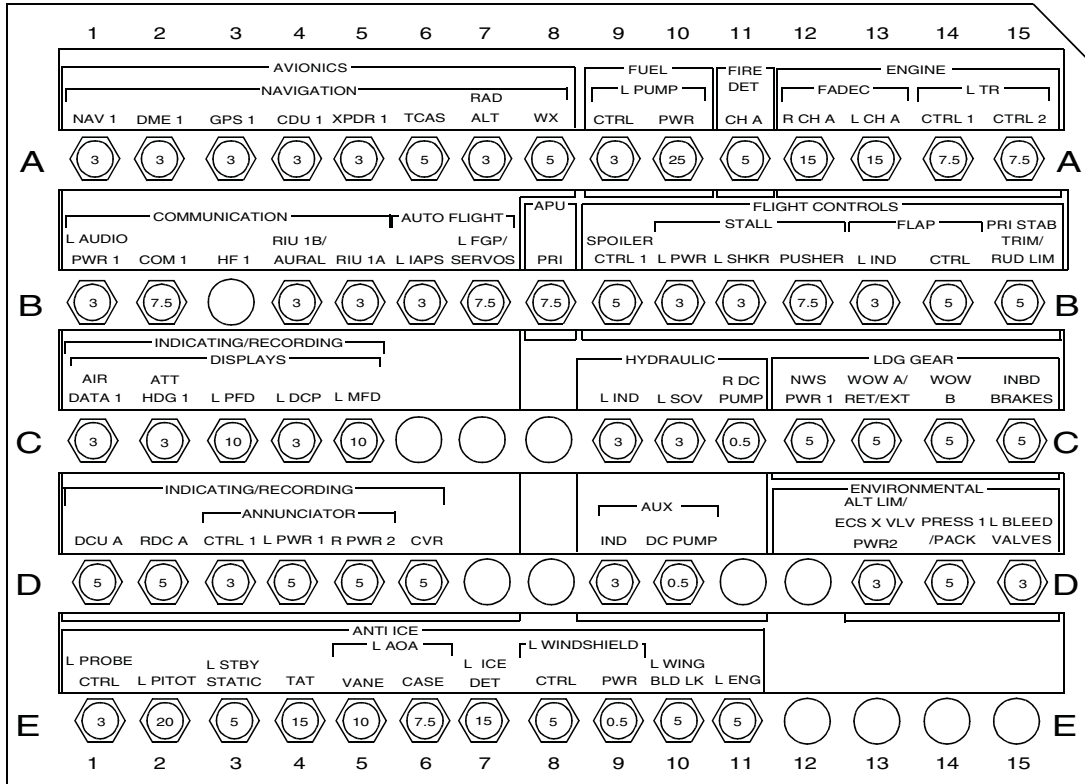

CFO0106002_006

Challenger Global 300 - Electrical

ELECTRICAL SYSTEM (Cont)

CB2 COPILOT CIRCUIT BREAKER PANEL (TYPICAL)

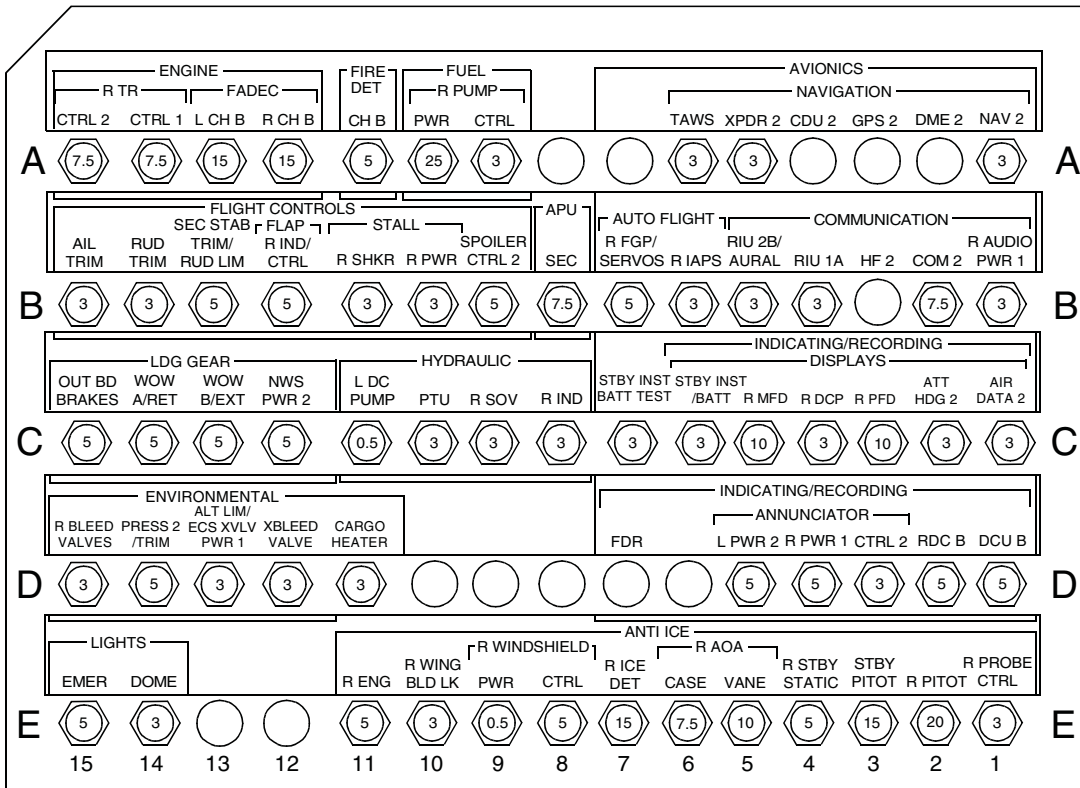

CFC0106002_005

Challenger Global 300 - Electrical

ELECTRICAL SYSTEM (Cont)

CB3 LEFT SIDE EQUIPMENT RACK CIRCUIT BREAKER PANEL (TYPICAL)

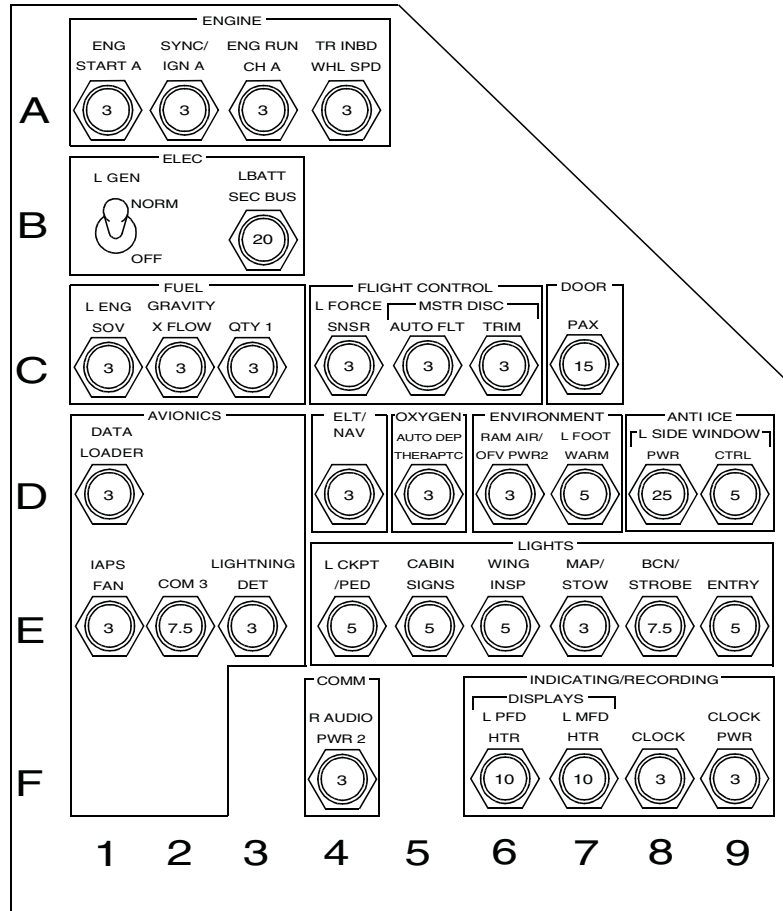

CFC0106002_004

Challenger Global 300 - Electrical

ELECTRICAL SYSTEM (Cont)

CB4 RIGHT SIDE EQUIPMENT RACK CIRCUIT BREAKER PANEL (TYPICAL)

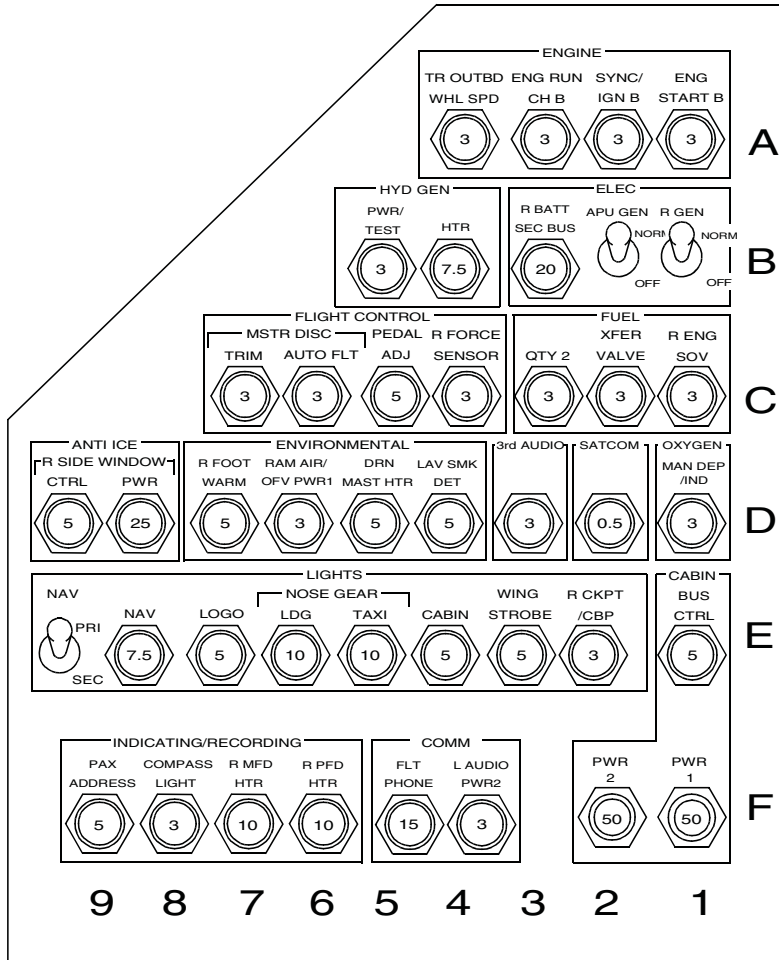

CFO0106002_003

Challenger Global 300 - Electrical

ELECTRICAL SYSTEM (Cont)

CB5 LEFT DC POWER CENTER CIRCUIT BREAKER PANEL (TYPICAL)

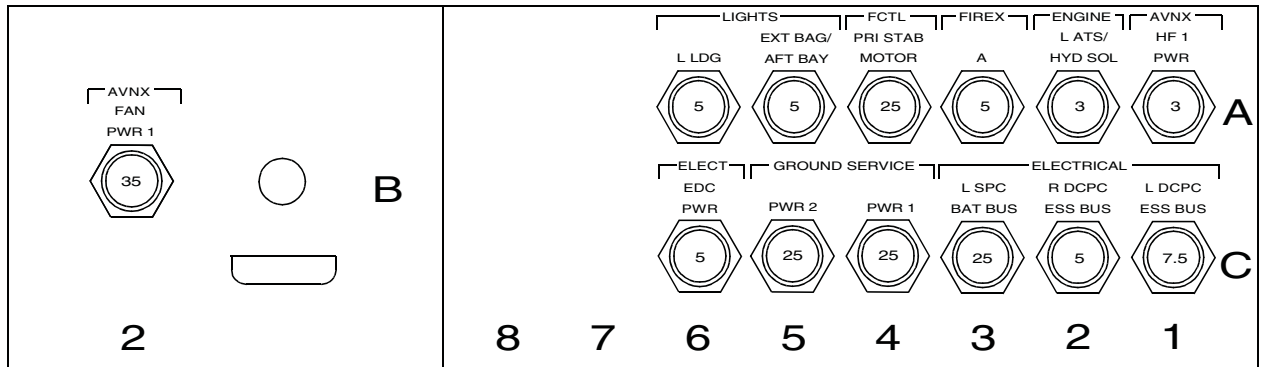

CFO0106002_002

CB6 RIGHT DC-POWER CENTER CIRCUIT BREAKER PANEL (TYPICAL)

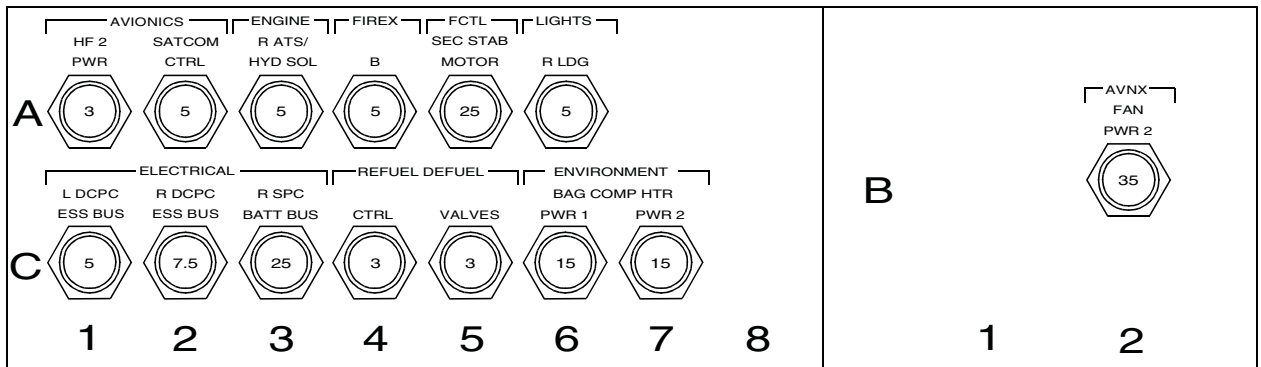



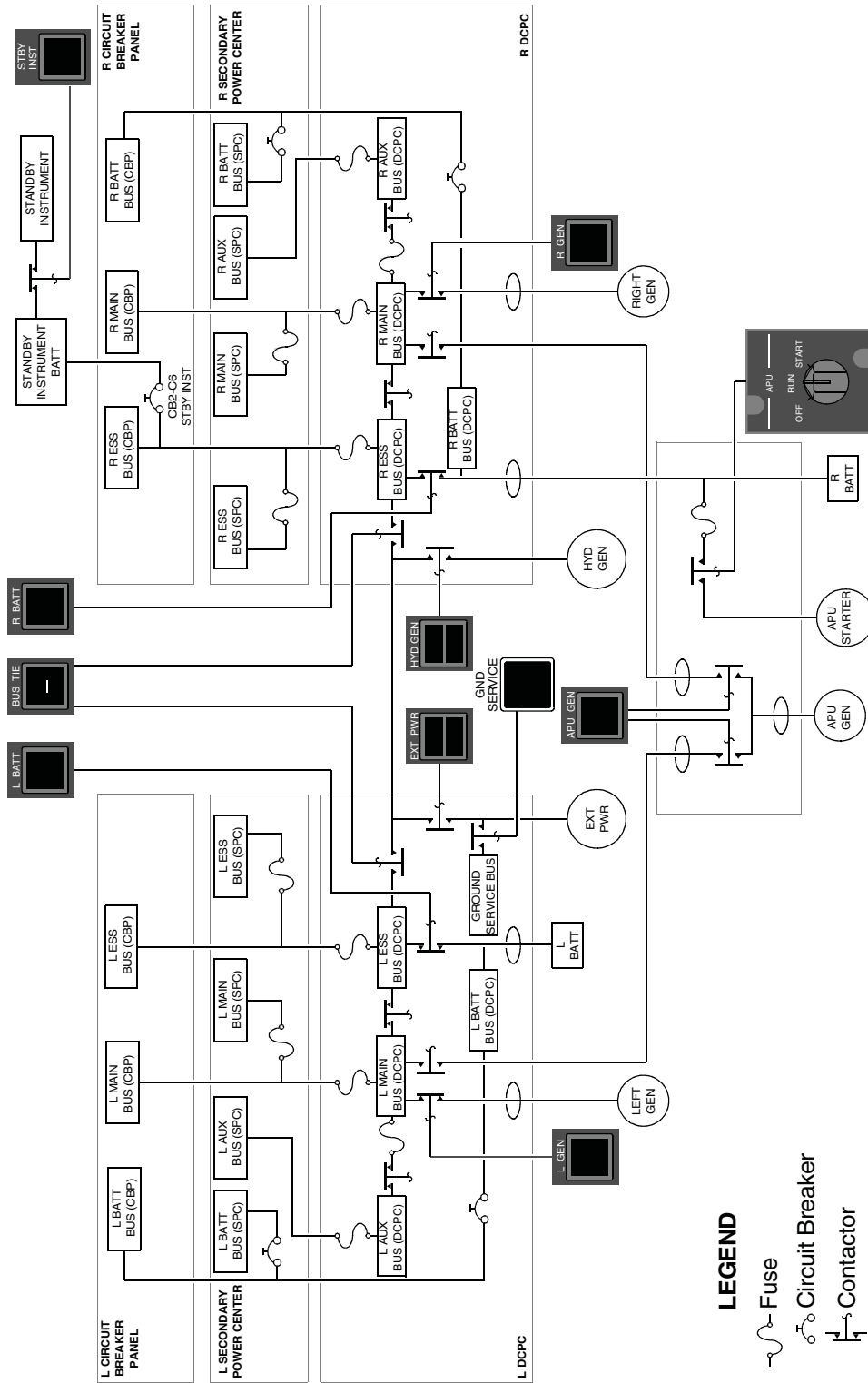

CFO0106002_001

DIRECT CURRENT SYSTEM (DC)

DC ELECTRICAL SYSTEM

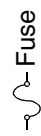

LEGEND

-  Fuse
-  Circuit Breaker
-  Contactor
-  Current Sensor

CFO0701002_011

DIRECT CURRENT SYSTEM (DC) (Cont)

DC PRIMARY ARCHITECTURE

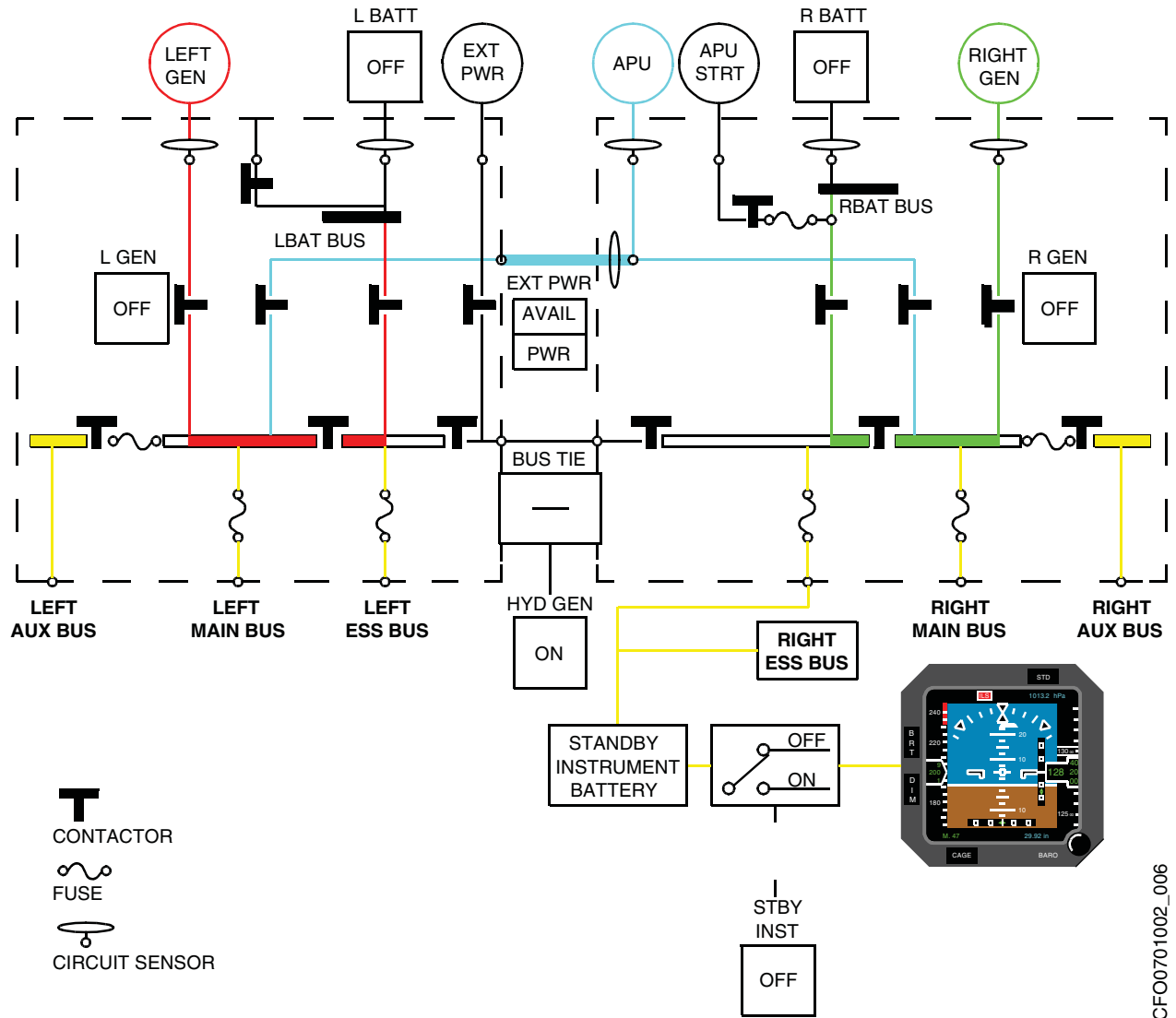

CFO0701002_006

CONTROLS AND INDICATIONS

EXTERNAL POWER CONTROL PANEL

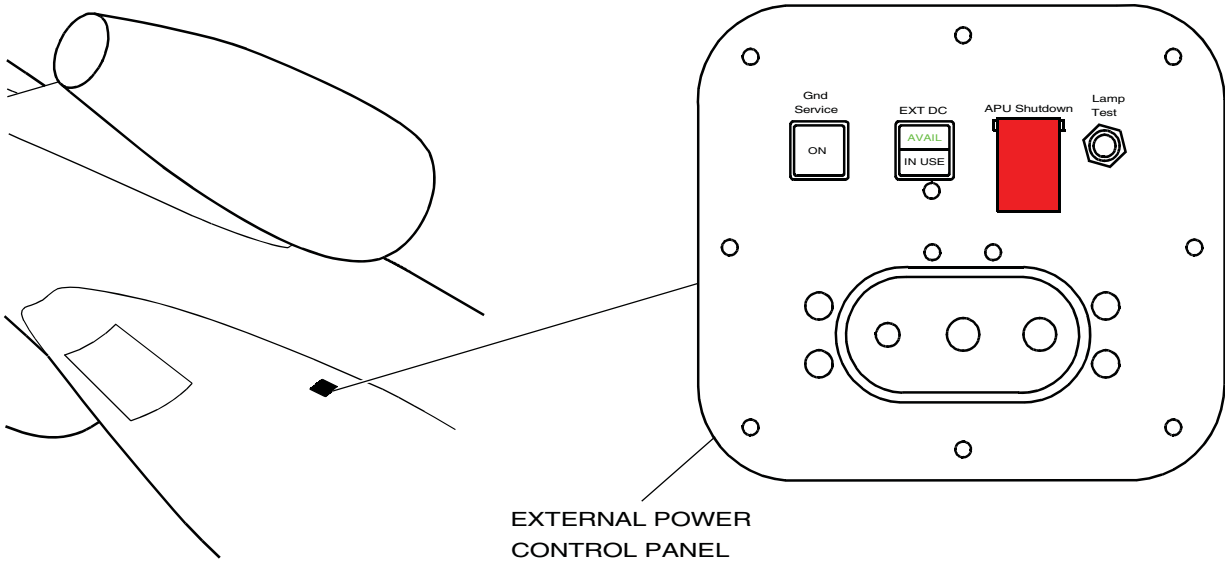

CFC0501002_006

CONTROLS AND INDICATIONS (Cont)

ELECTRICAL SUMMARY PAGE

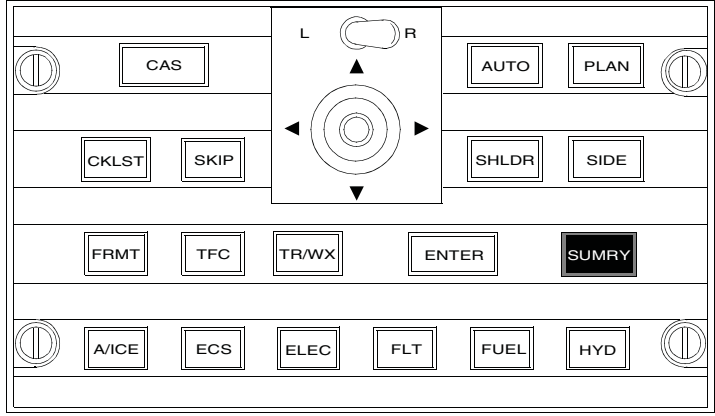
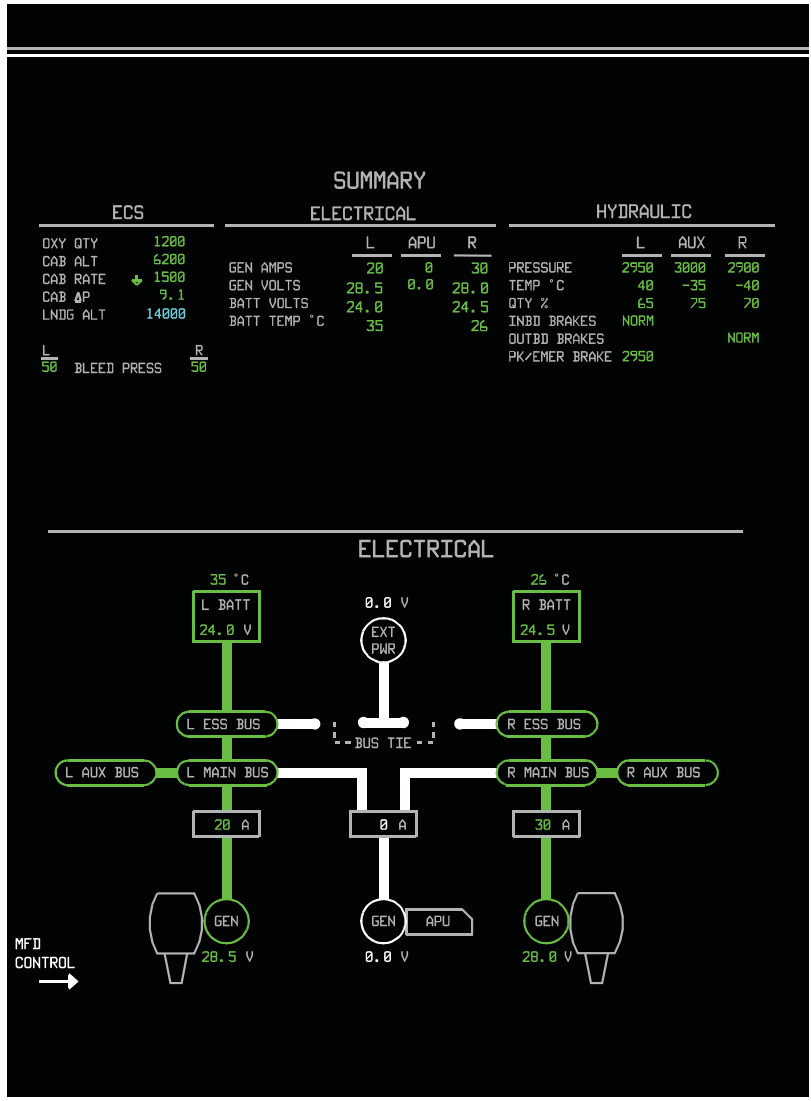

CFO0701002_009

CONTROLS AND INDICATIONS (Cont)

ELECTRICAL CONTROL PANEL

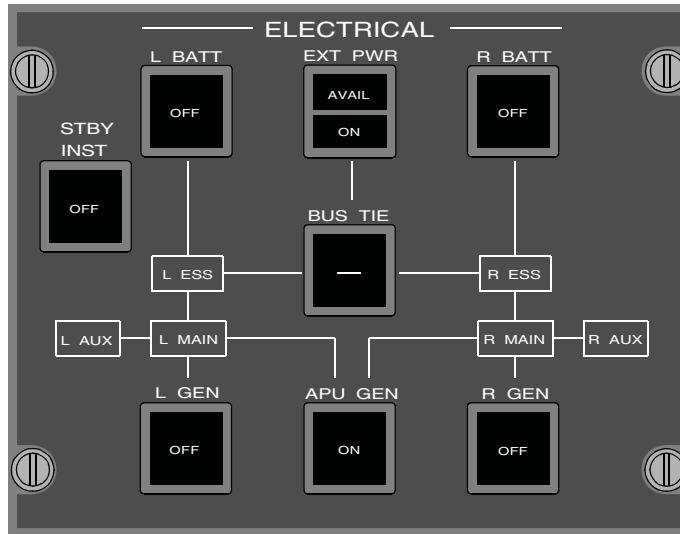

CFO0701002_010

With optional Hydraulic Motor Driven Generator (HMDG) system.

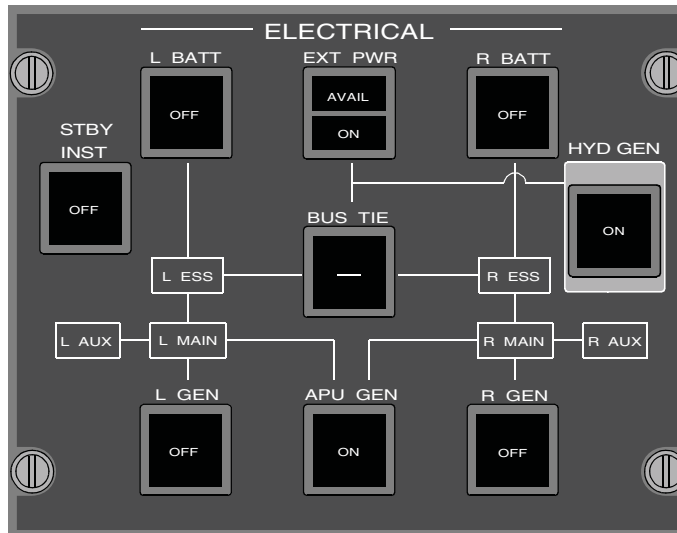

CFO0701002_003

CONTROLS AND INDICATIONS (Cont)

ELECTRICAL SYNOPTIC PAGE

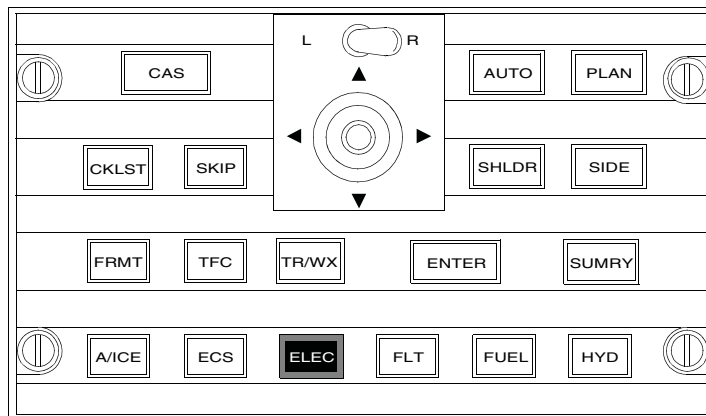
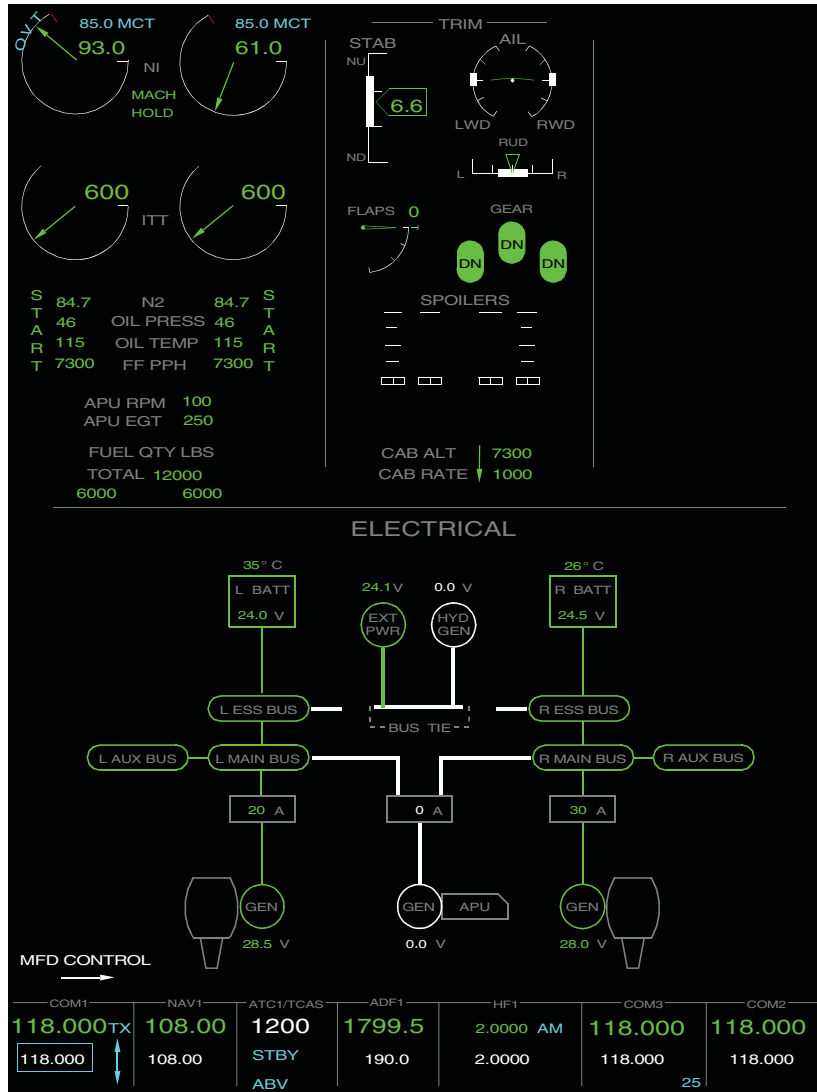

CFO0701002_007

Challenger Global 300 - Electrical

EICAS MESSAGES

The electrical system messages are shown on the EICAS. In the table below is a list of the electrical system messages, inhibits, and aural warnings. A brief explanation of each message is provided.

MESSAGE	INHIBITS	MEANING	AURAL WARNING
L (R) BATT OVERHEAT	TO/LAND	Respective battery internal temperature exceeded 70 °C	
ESSENTIAL POWER ONLY		The essential buses are powered by the batteries only. AUX and MAIN buses are automatically deactivated in flight	
APU GEN FAIL	TO/LAND	The APU generator failed	
APU GEN OVERLOAD	TO/LAND	The APU generator has exceeded 500 amp	
L (R) BATT FAIL	TO/LAND	Either the respective battery contactor failed or the battery has been automatically disconnected for overheat protection	
ELEC HYD GEN FAIL	TO/LAND	The hydraulic generator has failed to come on-line	
ELECTRICAL FAULT	TO/LAND	An electrical system failure has occurred that prevents display of electrical indications	
L (R) GEN FAIL	TO/LAND	The affected generator has failed. If the APU generators not on line, the BUS-TIE will automatically close and, in-flight, the auxiliary buses will not be powered	
L (R) ESS BUS FAIL	TO/LAND	Affected bus is not powered	
L (R) GEN OVERLOAD	TO/LAND	Respective generator load exceeded 500 amp	
L (R) MAIN BUS FAIL	TO/LAND	The affected MAIN bus is not powered	
L (R) AUX BUS FAIL	TO/LAND	The affected auxiliary BUS is not powered with a power source available	
L (R) AUX BUS OFF	TO/LAND	Respective AUX BUS is selected off	
ELECTRICAL FAULT	TO/LAND	An electrical system fault occurred, resulting in loss of redundancy in the display of electrical indications	

Challenger Global 300 - Electrical

MESSAGE	INHIBITS	MEANING	AURAL WARNING
STBY INST BATT FAULT	TO/LAND	At least one of the following has occurred: - Standby instrument heater is inoperative - Standby instrument battery charger is inoperative - Standby instrument battery temperature is greater than 80 °C - At least two cells of the standby instrument battery have failed	
APU GEN OFF		APU GEN switch has been selected OFF	
L (R) BATT OFF		The affected battery has been selected OFF	
BUS TIE MAN OPEN		The bus tie has been manually selected open. This prevents automatic operation of the bus tie. Pressing the BUS TIE switch a second time restores automatic control	
ELEC HYD GEN ON		The optional hydraulic motor driven generator (HMDG) has been activated	
L (R) GEN OFF		The affected engine generator switch has been selected OFF	