

**EMERGENCY EQUIPMENT
TABLE OF CONTENTS**

CHAPTER 8

	Page
TABLE OF CONTENTS	08-00-1
DESCRIPTION	
General	08-10-1
Placards	08-10-1
Oxygen	08-10-2
Flight Compartment	08-10-2
Oxygen Bottle	08-10-3
Oxygen Ground Service Panel	08-10-4
Crew Mask Storage	08-10-5
Crew Mask	08-10-6
Passenger Oxygen	08-10-8
Oxygen System EICAS Messages	08-10-9
Oxygen System Quantity Readout	08-10-10
Crew Oxygen Consumption Data	08-10-11
Evacuation Devices	08-10-13
Exit Lighting	08-10-14
Emergency Exit – Passenger Door	08-10-14
Overwing Emergency Exit	08-10-15
Overwing Emergency Exit – External	08-10-15
Overwing Emergency Exit – Internal	08-10-16
Fire Fighting Equipment	08-10-17
Portable Fire Extinguisher	08-10-17
Over Water Emergency Equipment	08-10-19
Life Vest	08-10-19
EMS CIRCUIT PROTECTION	
CB – Oxygen	08-20-1

EMERGENCY EQUIPMENT
TABLE OF CONTENTS

THIS PAGE INTENTIONALLY LEFT BLANK

GENERAL

This chapter describes the systems and equipment which are essential to the safety of passengers and crew during a fire, rapid decompression, ditching and emergency evacuation. These include the following equipment:

- Oxygen equipment (portable and fixed).
- Evacuation devices (crash axe, emergency lighting and emergency exits).
- Fire fighting equipment (portable and fixed).
- Over water emergency equipment (life vests).

PLACARDS

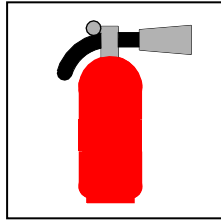

HALON FIRE
EXTINGUISHER

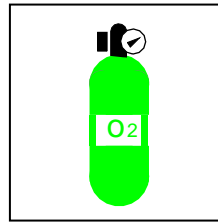

OXYGEN CYLINDER

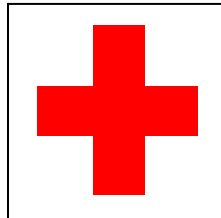

FIRST AID KIT



GF0810_001

OXYGEN

A gaseous oxygen system is supplied by four cylinders to serve the flight crew and passengers.

FLIGHT COMPARTMENT

The flight compartment oxygen system consists of the following:

- Four oxygen bottles (with a pressure regulator unit, bottle gauge and shut-off valve).
- Ground servicing panel (with a gauge and filler valve).
- Fuselage-mounted overboard relief valve (frangible disc).
- Two oxygen mask/regulator units and goggles.

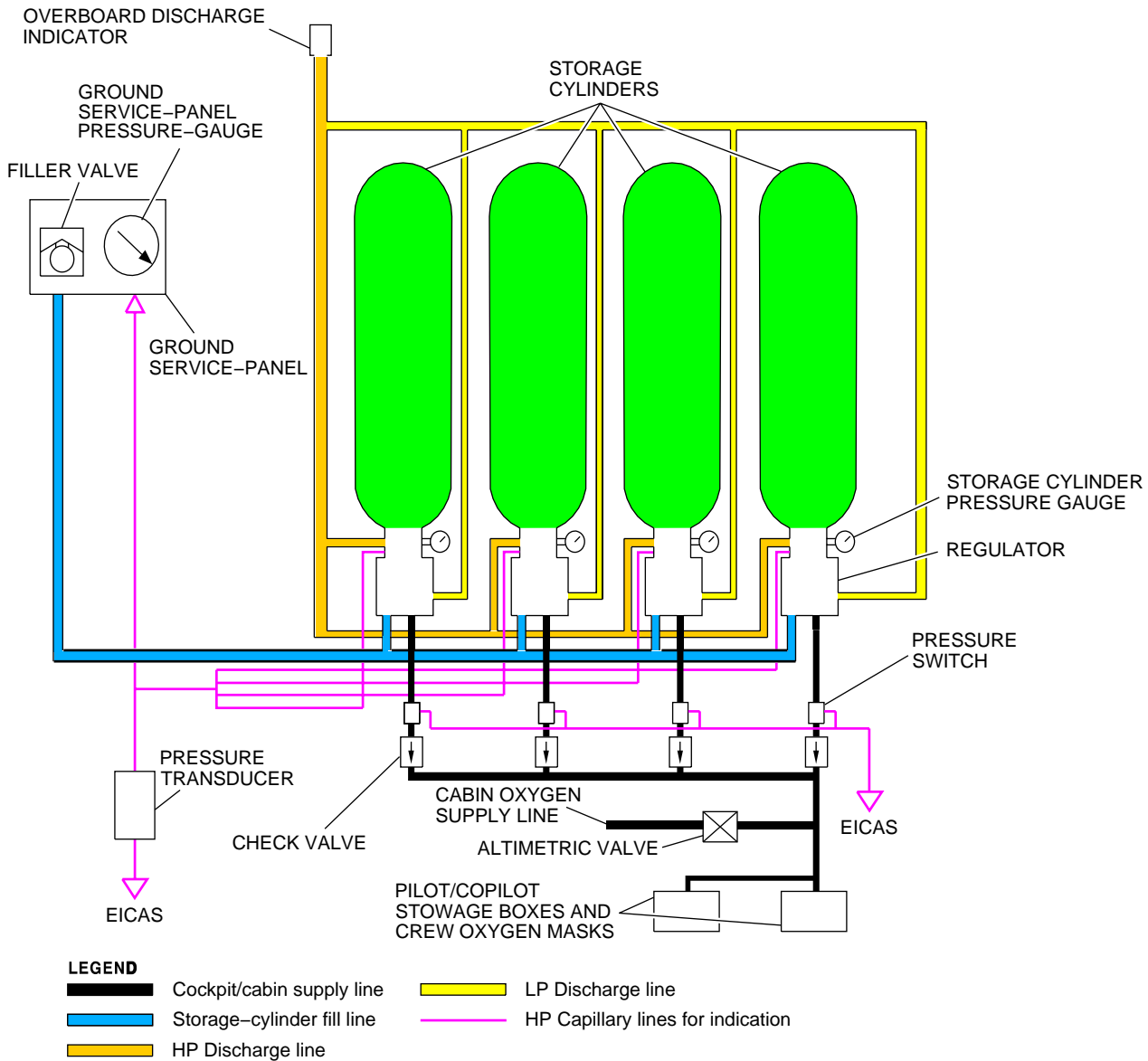

GF0810_002a

OXYGEN BOTTLE

The oxygen bottles [1416 liter (50.0 cubic feet)] are located in the forward fuselage underfloor area. Normal charge pressure at 21 °C (70 °F) is 1850 psi.

Charge pressure is indicated as follows:

- Gauge on the bottle regulator
- Gauge on the ground servicing panel
- Oxygen quantity is indicated on the EICAS status page

When bottle pressure becomes excessive, approximately 2600 psi, all oxygen is vented overboard by a pressure regulator unit working in conjunction with a fuselage-mounted relief valve. Overpressure causes the OXY HP RELIEF disc, located on the left front fuselage to blow out.

The pressure regulator unit regulates flow to the crew mask regulator unit to 72.5 psi and the unit's strain gauge transmits pressure signals to EICAS.

The crew mask/regulator unit regulates the flow to the crew masks. Oxygen is supplied via the regulator at either ambient or slightly over ambient pressure dependent upon crew setting of the flow controls.

The flight crew oxygen system is a diluter demand system. The flight crew oxygen masks are of the quick-donning, inflatable harness type. Each mask is stowed in a quick access container adjacent to each flight station (one each at the side consoles).

A regulator in each mask provides, by pilot selection, for three oxygen supply modes:

- Normal diluted demand mode.
- 100 percent oxygen on demand mode
- 100 percent oxygen continuous flow/variable pressure mode (emergency mode).

When stowed in the container, the oxygen flow through the regulator can be tested by pressing the test lever. Each mask is equipped with a microphone.

Oxygen for the passengers is supplied by the same oxygen system as for the crew, via the altimetric valve to the passenger drop out mask boxes in the cabin, in the event of cabin depressurization.

The oxygen masks are installed in overhead compartments and are available at all passenger seats and in the lavatory.

All oxygen compartment doors will open to present the oxygen masks automatically, if cabin altitude reaches approximately 14,500 feet.

When the oxygen compartment doors open, the passengers will pull the oxygen mask to their face, pulling the lanyard and pin from the generator. This initiates the flow of oxygen to the passenger's oxygen mask.

OXYGEN GROUND SERVICE PANEL

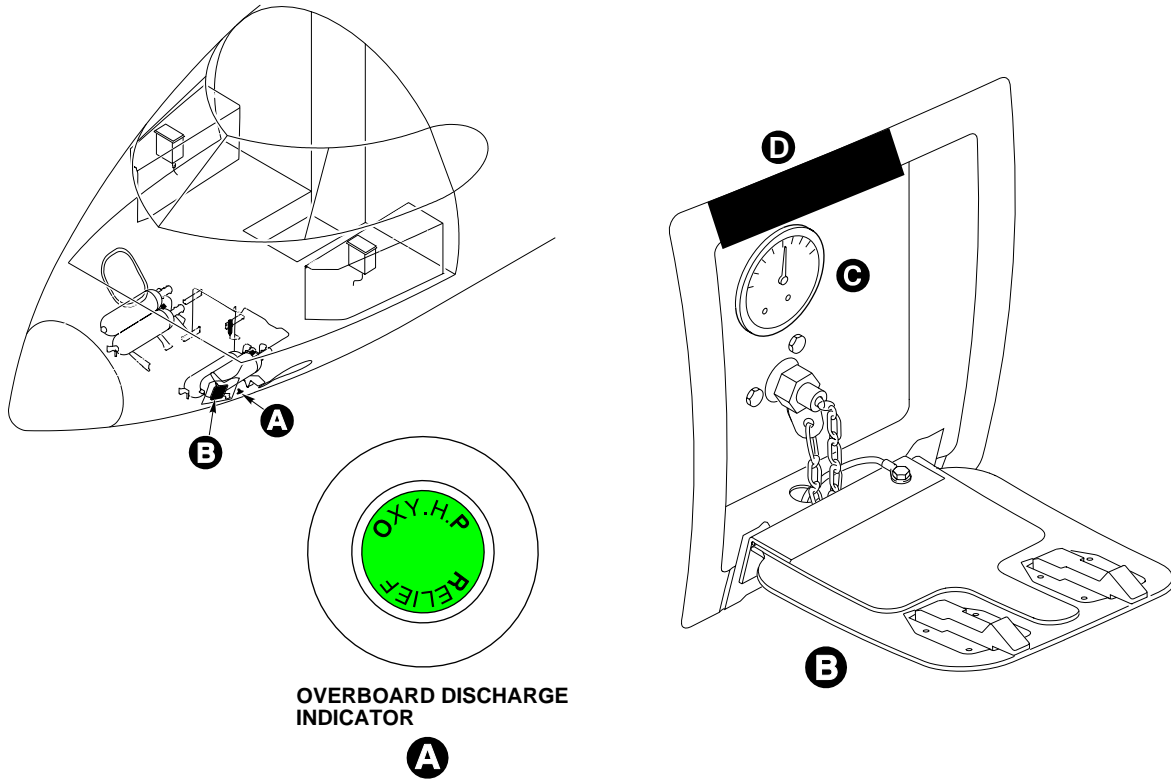

OXYGEN CYLINDER SERVICING: CHARGE CYLINDER AT RATE NOT TO EXCEED 200 PSI/MIN TO "FULL" PRESSURE									
AMBIENT TEMP ° F	100	80	60	40	20	0	-20	-40	
FULL PRESS PSI	1990	1900	1805	1710	1620	1530	1435	1340	

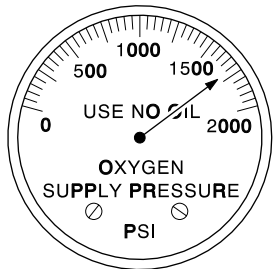

GROUND SERVICE PANEL
PRESSURE GAUGE

GF0810_003

CREW MASK STORAGE

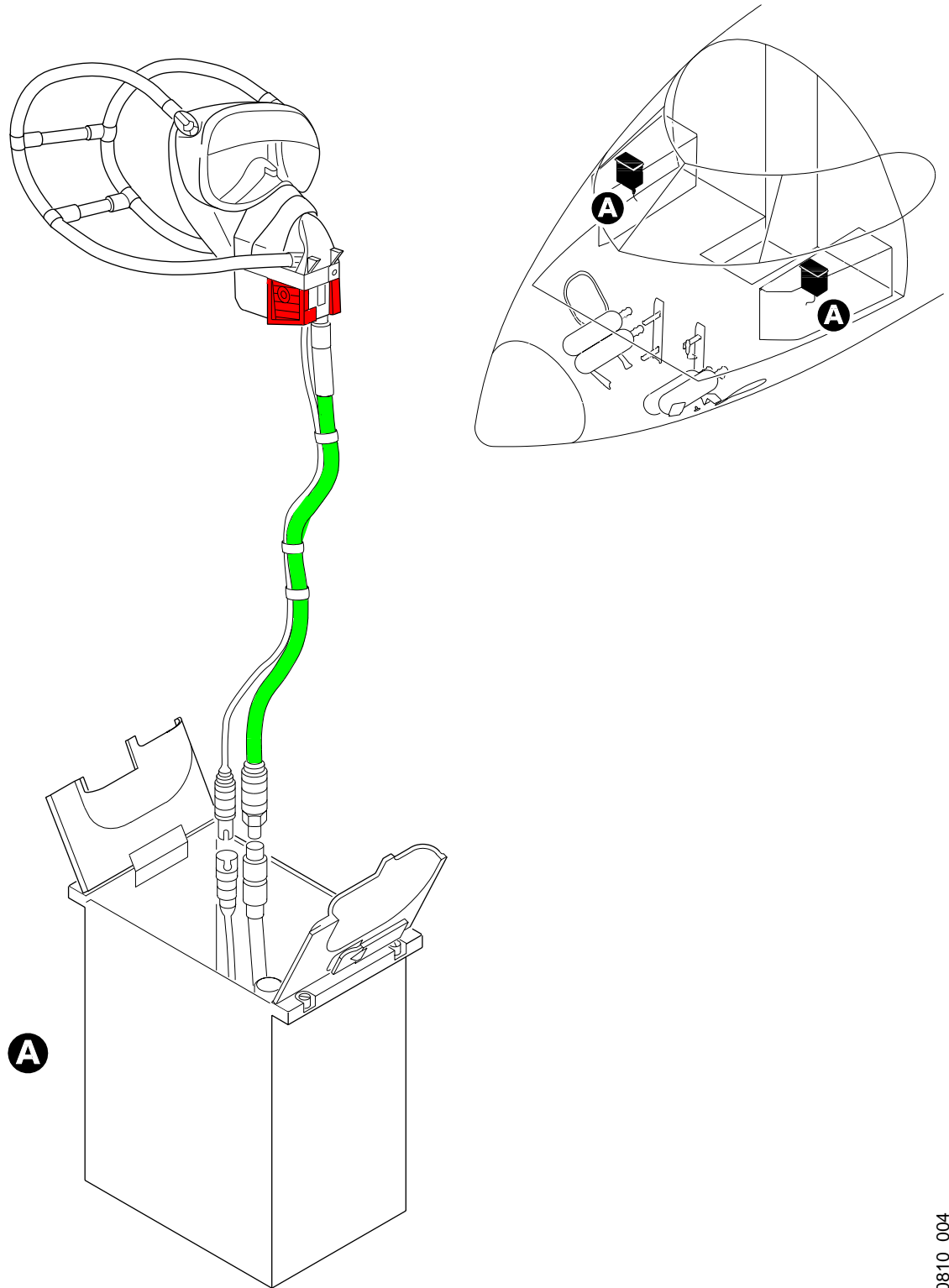

GF0810_004

CREW MASK

Blinker

Shows yellow cross when oxygen is flowing or when harness is inflated. When black, indicates no oxygen flow.

Normal/100% Lever

- **N** provides a mixture of Ambient air with oxygen on demand.
- **100%** provides 100% oxygen on demand.

Release Levers

Squeeze to unlock container doors, grasp levers and hose and pull to withdraw mask.

RESET/TEST Lever (spring-loaded to RESET)

Press to test oxygen flow (momentarily) through the regulator (microphone test without pulling the mask out).

Oxygen On Flag

In view when mask is out, indicates that oxygen shut-off valve is open. Flag will disappear when shut-off valve closed. Reset position shuts off supply to mask regulator and blinker unit.

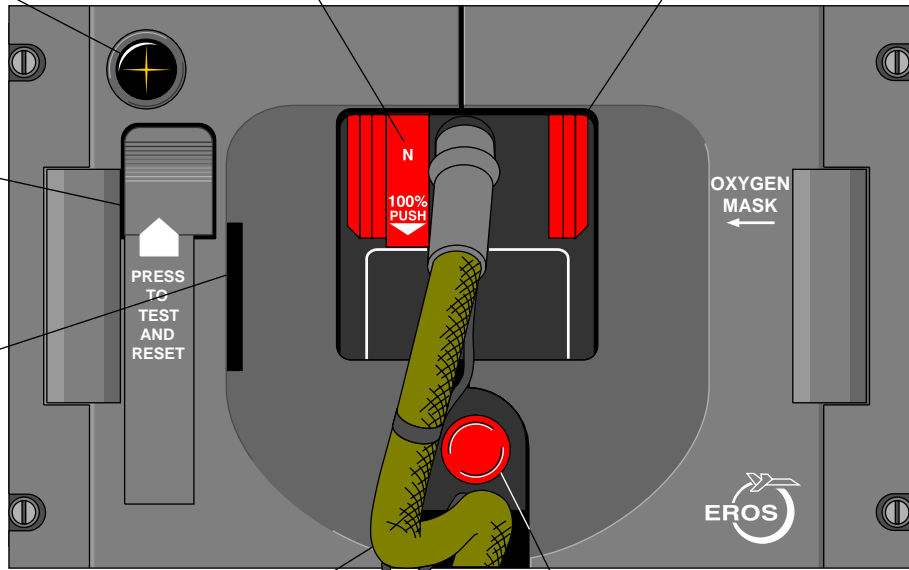

Oxygen Supply Hose

Emergency Flow Control

- Rotate in direction of arrow to supply a continuous 100% oxygen flow.
- Rotate to adjust the supply pressure.
- Press to test whether a continuous flow will be available.

GF0810_005a

CREW MASK (CONT'D)

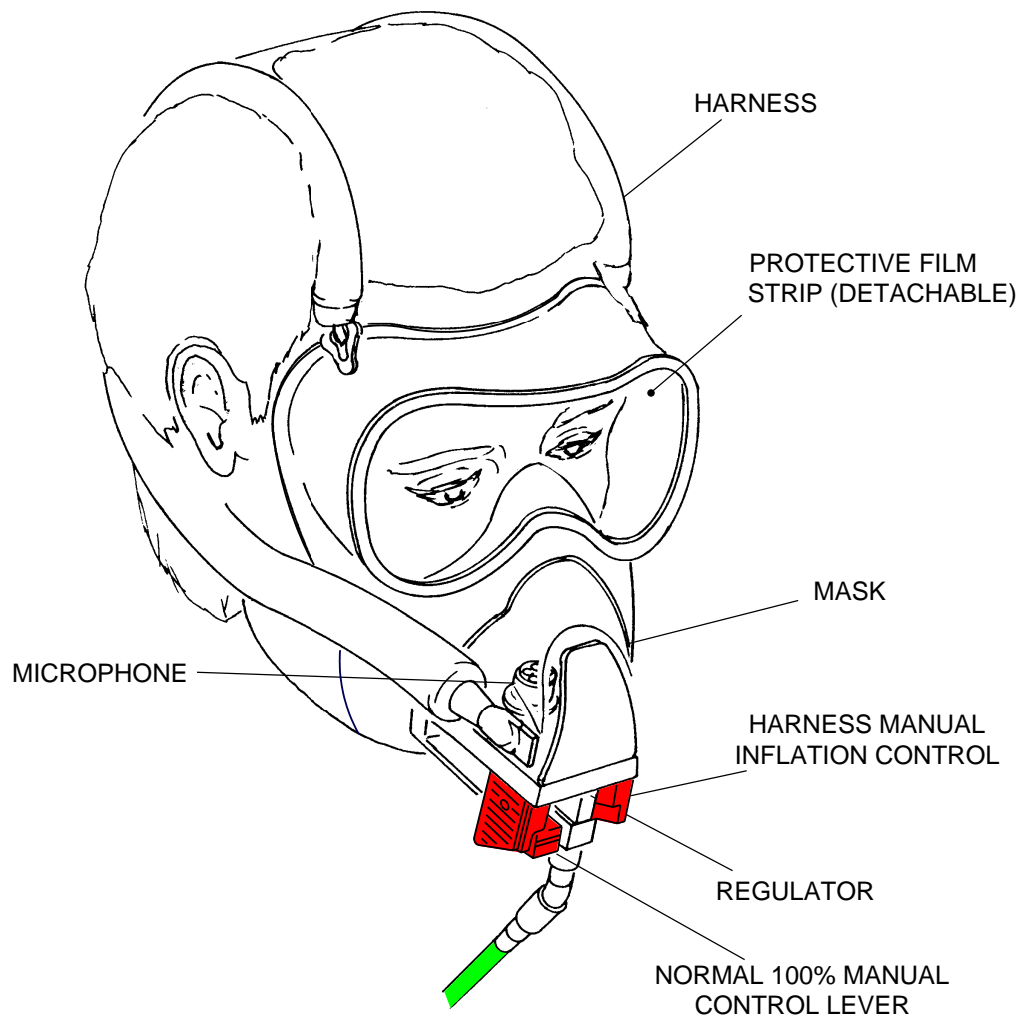

GF0810_006

PASSENGER OXYGEN

The passenger oxygen control panel located on the Copilot's side panel, is equipped with an altimetric valve (4 modes). The control panel has a rotary switch that lets the crew choose between three operating modes of the altimetric valve.

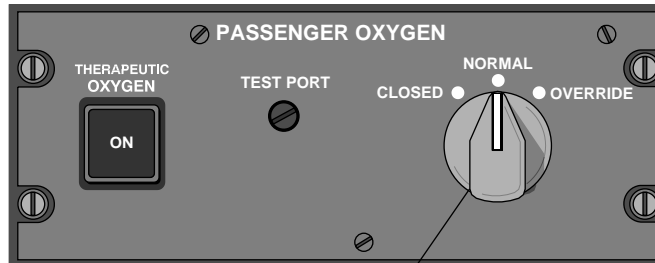

Altimetric Valve Rotary Switch

The four modes of operation are:

- NORMAL** – Supplies oxygen automatically to the passenger compartment when cabin altitude reaches 14,500 feet (+500/-750 feet).
- OVERRIDE** – Overrides the altitude switch in the control panel and supplies oxygen to the passenger compartment regardless of altitude.
- CLOSED** – Stops oxygen supply to the passenger compartment.

FGF0810_001

When the cabin altitude reaches 14,500 feet (+500/-750 feet), a message will appear on EICAS, when the altimetric valve is set at **NORMAL** and there is oxygen flow in the passenger compartment.

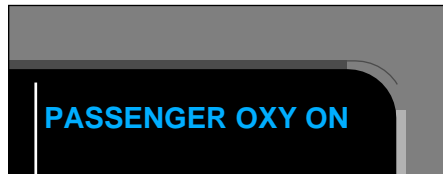

GF0810_008

OXYGEN SYSTEM EICAS MESSAGES

OXYGEN LO QTY

Indicates that crew oxygen bottle has \leq 75 % oxygen (1400 PSI).

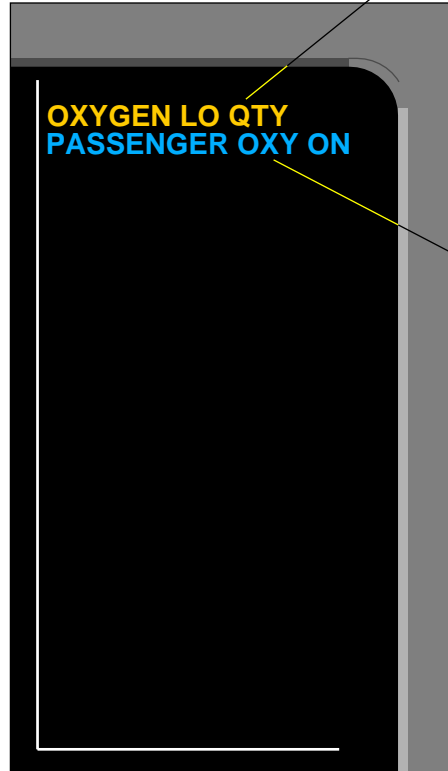

PASSENGER OXY ON

Indicates that the passenger oxygen system has been activated.

GF0810_009a

OXYGEN SYSTEM QUANTITY READOUT

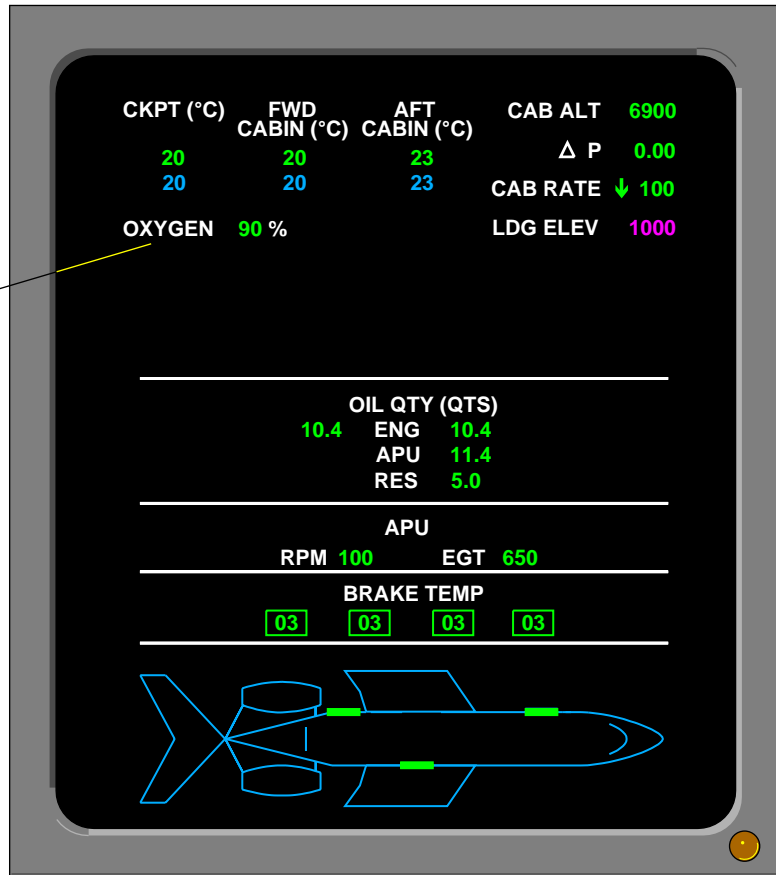

GF0810_010a

Oxygen System Quantity Readout
Indicates oxygen system quantity in increments of 1%

Colors are:

- Amber – ≤ 75%.
- Green – > 75%.

CREW OXYGEN CONSUMPTION DATA

The following tables show the total time (in hours, minutes and seconds) that oxygen will be available at various mask settings, during various flight conditions, at initial bottle pressures of 75% and 100%. A margin of safety of 10% was subtracted from the full charge of 100% in all cases.

NOTE

Passenger oxygen consumption was not a factor in the creation of these tables.

LEVEL FLIGHT AT CABIN PRESSURE ALTITUDE OF 8,000 FEET					
Crew members		2		3	
Initial Bottle Pressure		75%	100%	75%	100%
Normal Mask Setting		10hrs 02 min	13hrs 37min	06hrs 41min	09hrs 05min
100% Mask Setting		02hrs 12min	02hrs 59min	01hr 28min	01hr 59min
Emergency Mask Setting		02hrs 04min	02hrs 49min	01hr 23min	01hr 52min

DESCENT (10 Min.) FROM 41,000 feet TO LEVEL FLIGHT AT SAFE ALTITUDE (NORMAL MASK SETTING FOR BOTH DESCENT AND LEVEL FLIGHT)					
Crew member		2		3	
Initial Bottle Pressure		75%	100%	75%	100%
Cabin Pressure Altitude	10,000 Feet	10hrs 28min	14hrs 52min	06hrs 52min	09hrs 48min
	14,000 Feet	10hrs 05min	14hrs 17min	06hrs 37min	09hrs 26min
	18,000 Feet	08hrs 25min	11hrs 56min	05hrs 32min	07hrs 52min
	21,000 Feet	07hrs 02min	09hrs 57min	04hrs 37min	06hrs 34min

DESCENT (10 Min.) FROM 41,000 feet TO LEVEL FLIGHT AT SAFE ALTITUDE (100% MASK SETTING FOR DESCENT AND NORMAL MASK SETTING FOR LEVEL FLIGHT)					
Crew members		2		3	
Initial Bottle Pressure		75%	100%	75%	100%
Cabin Pressure Altitude	10,000 Feet	10hrs 17min	14hrs 41min	06hrs 41min	09hrs 37min
	14,000 Feet	09hrs 58min	14hrs 11min	06hrs 31min	09hrs 19min
	18,000 Feet	08hrs 22min	11hrs 53min	05hrs 29min	07hrs 50min
	21,000 Feet	07hrs 01min	09hrs 56min	04hrs 37min	06hrs 34min

DESCENT (10 Min.) FROM 41,000 feet TO LEVEL FLIGHT AT SAFE ALTITUDE (100% MASK SETTING FOR BOTH DESCENT AND LEVEL FLIGHT)					
Crew members		2		3	
Initial Bottle Pressure		75%	100%	75%	100%

CREW OXYGEN CONSUMPTION DATA (CONT'D)

DESCENT (10 Min.) FROM 41,000 feet TO LEVEL FLIGHT AT SAFE ALTITUDE (100% MASK SETTING FOR BOTH DESCENT AND LEVEL FLIGHT)					
Cabin Pressure Altitude	10,000 Feet	02hrs 04min	02hrs 57min	01hr 21min	01hr 56min
	14,000 Feet	02hrs 18min	03hrs 17min	01hr 30min	02hrs 09min
	18,000 Feet	03hrs 01min	04hrs 17min	01hr 59min	02hrs 50min
	21,000 Feet	03hrs 30min	04hrs 58min	02hrs 18min	03hrs 17min

EVACUATION DEVICES

To assist in emergency escape and aid in rescue operation, emergency lighting, emergency exits, a crash axe and escape rope are provided:

- Crash axe – Behind copilot's seat

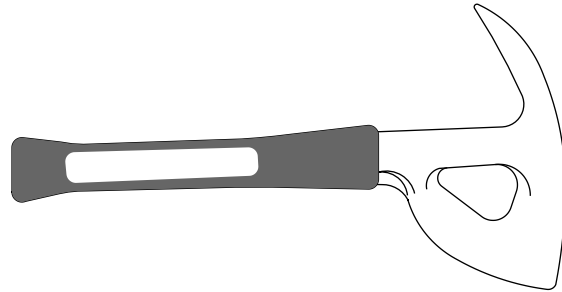
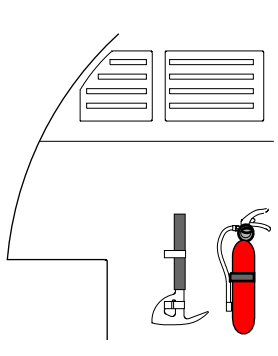

GF0810_015

- Cabin escape rope – Access panel adjacent to overwing exit.

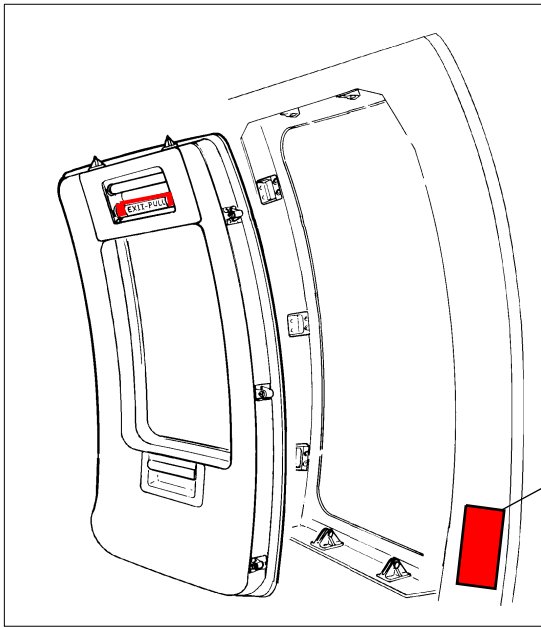

LIFE LINE
(NOT PLACARDED)

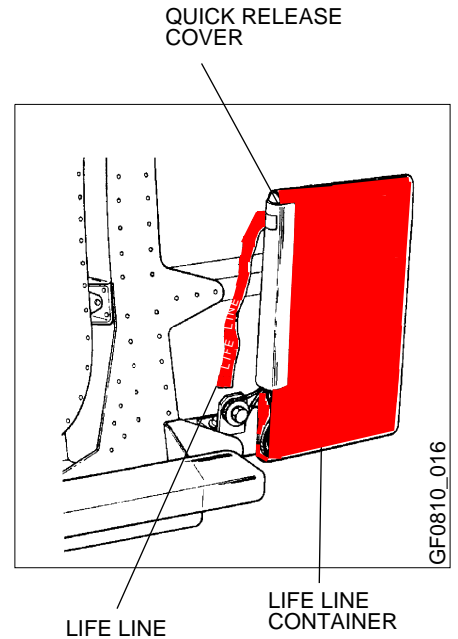

GF0810_016

EXIT LIGHTING

The airplane is equipped with an emergency lighting system consisting of the following:

- Four floodlights for illumination of the passenger cabin.
- Internal floodlights at the passenger door.
- Exterior evacuation floodlights at the passenger door and overwing exit areas.
- An escape path marking system at floor level.

The system is powered by four 28-volt rechargeable self contained power supply units that supply power for approximately 20 minutes when charged (see Chapter 16, Lighting, for details).

EMERGENCY EXIT - PASSENGER DOOR

This floor level door provides the most normal means of Type I emergency exits and should be used if possible. For more information see Chapter 1, DOORS

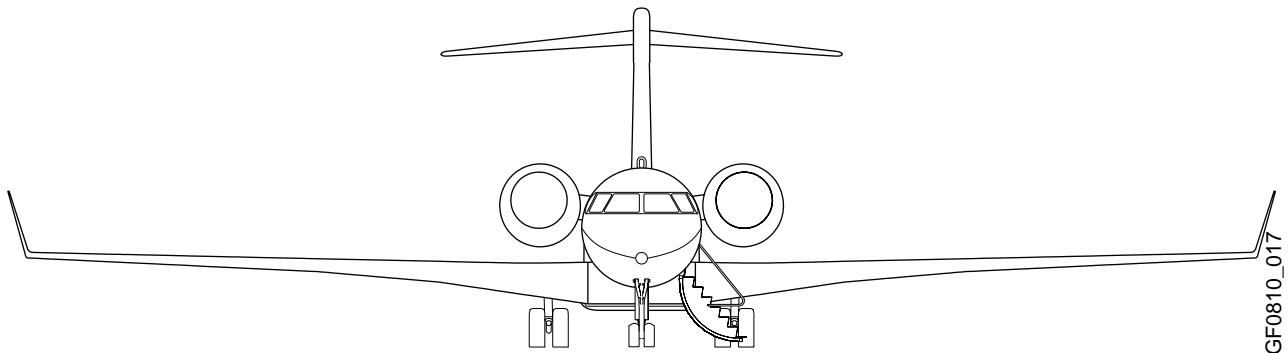

OVERWING EMERGENCY EXIT

There is one Type III overwing emergency exit over the right wing of the airplane and provides access to the upper wing surface. The exit opens inward from the top with a pull handle on the inside and a push plate on the outside. An escape rope (life line) is provided at the overwing exit.

OVERWING EMERGENCY EXIT - EXTERNAL

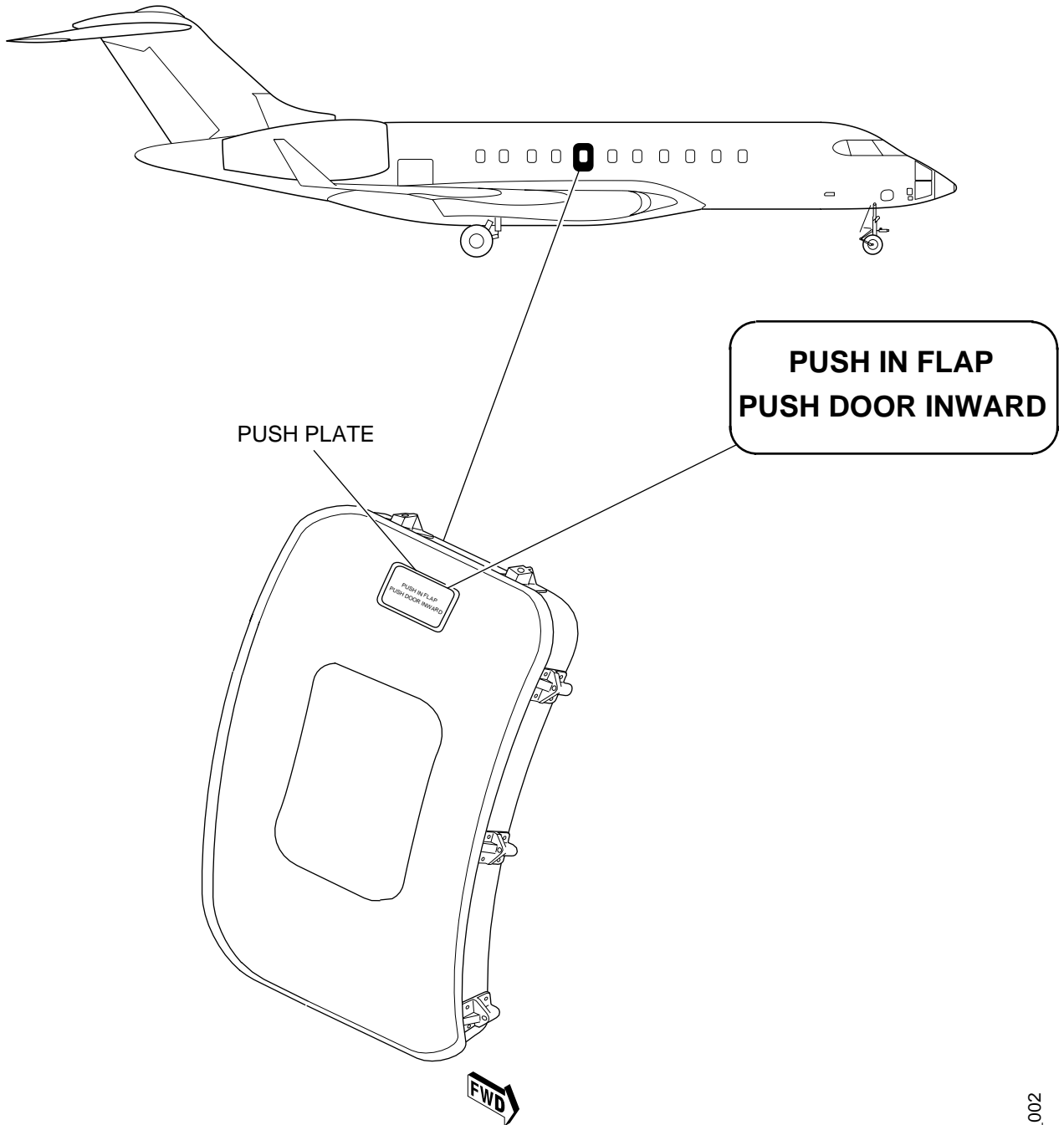

FGF0810_002

OVERWING EMERGENCY EXIT - INTERNAL

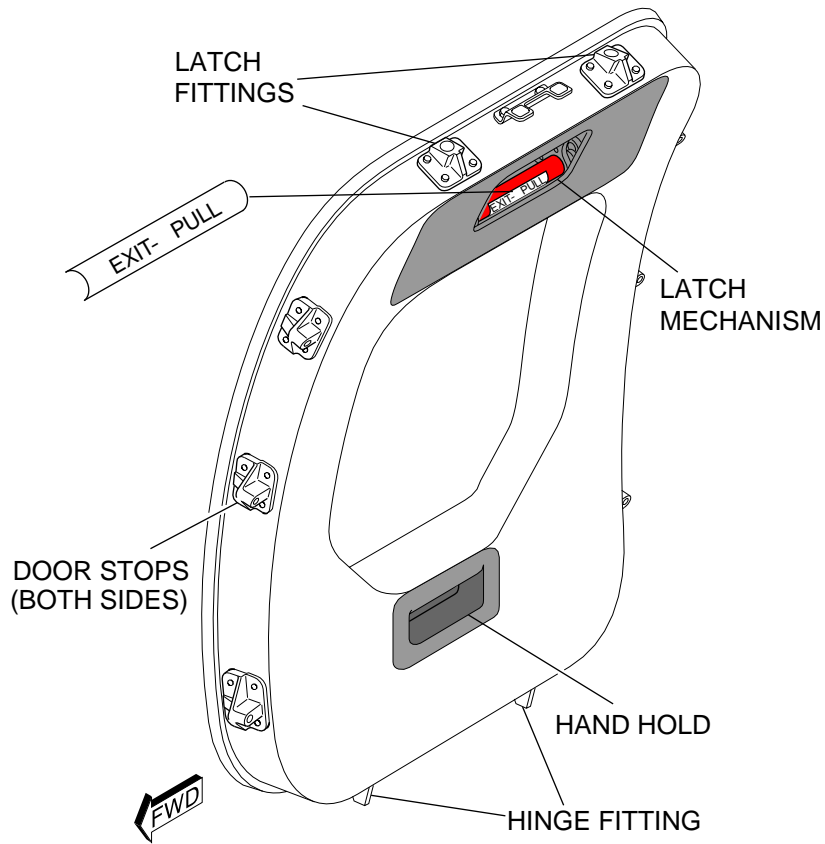

EMERGENCY EXIT
TO OPEN DOOR

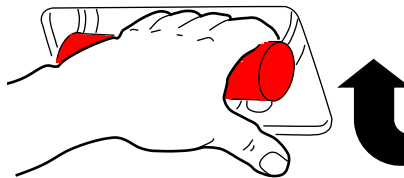

GF0810_019

FIRE FIGHTING EQUIPMENT

To fight a fire occurring inside the flight compartment and/or in the passenger cabin, the following equipment has been provided:

- Portable fire extinguishers
- Crash axe (behind copilot's seat)

PORTABLE FIRE EXTINGUISHER

A hand-operated fire extinguisher, located in the flight compartment, containing Halon 1211 is provided. Halon 1211 is effective on electrical, oil and fuel fires and is suitable for use in cold weather.

To operate: Remove from stowage bracket. Hold extinguisher upright in either hand, slide the locking pin down with thumb, aim the nozzle towards the base of the fire and press lever. Discharge stops when lever is released. Effective discharge time of 2-1/2 pound bottle is 8-15 seconds. Ventilate the compartment promptly after successfully extinguishing the fire to reduce gasses produced by fire and Halon. A distance of 9 to 15 feet from very hot fires or fires generating a dangerous amount of smoke, is recommended. If the discharge lever is held in the on position, the extinguisher is fully discharged in 10 seconds.

WARNING

If a fire extinguisher is to be discharged in the flight compartment, all flight crew must wear oxygen masks with EMERGENCY selected (100% oxygen).

Crew exposure to high levels of Halon vapors may result in dizziness, impaired coordination and reduced mental sharpness.

The fire extinguisher is effective in fighting Class A, B and C fires.

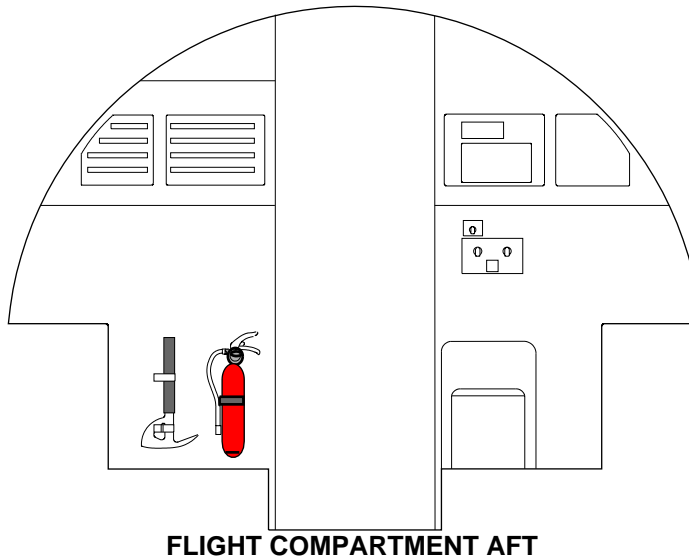

GF0810_021

PORTABLE FIRE EXTINGUISHER (CONT'D)

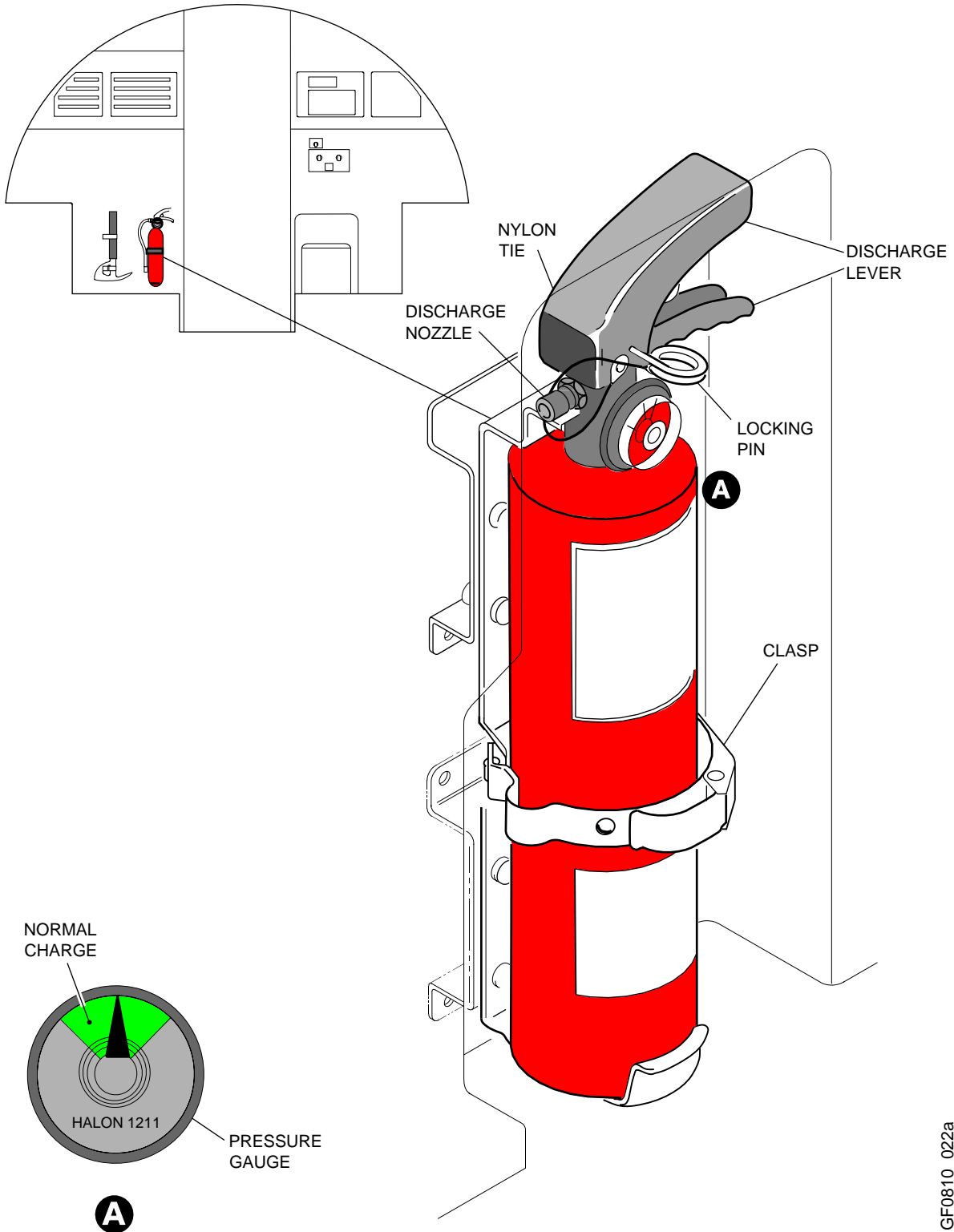

GF0810_022a

OVER WATER EMERGENCY EQUIPMENT

A life vest for each occupant of the flight compartment and the cabin is provided.

Each life vest includes a manual and an oral inflation system, a locator light and a system for automatic battery plugs removed during life vest deployment.

The flight crew members' life vests are stowed in a pocket beneath the crew member's seat.

The passenger life vests are stowed under each passenger seat.

LIFE VEST

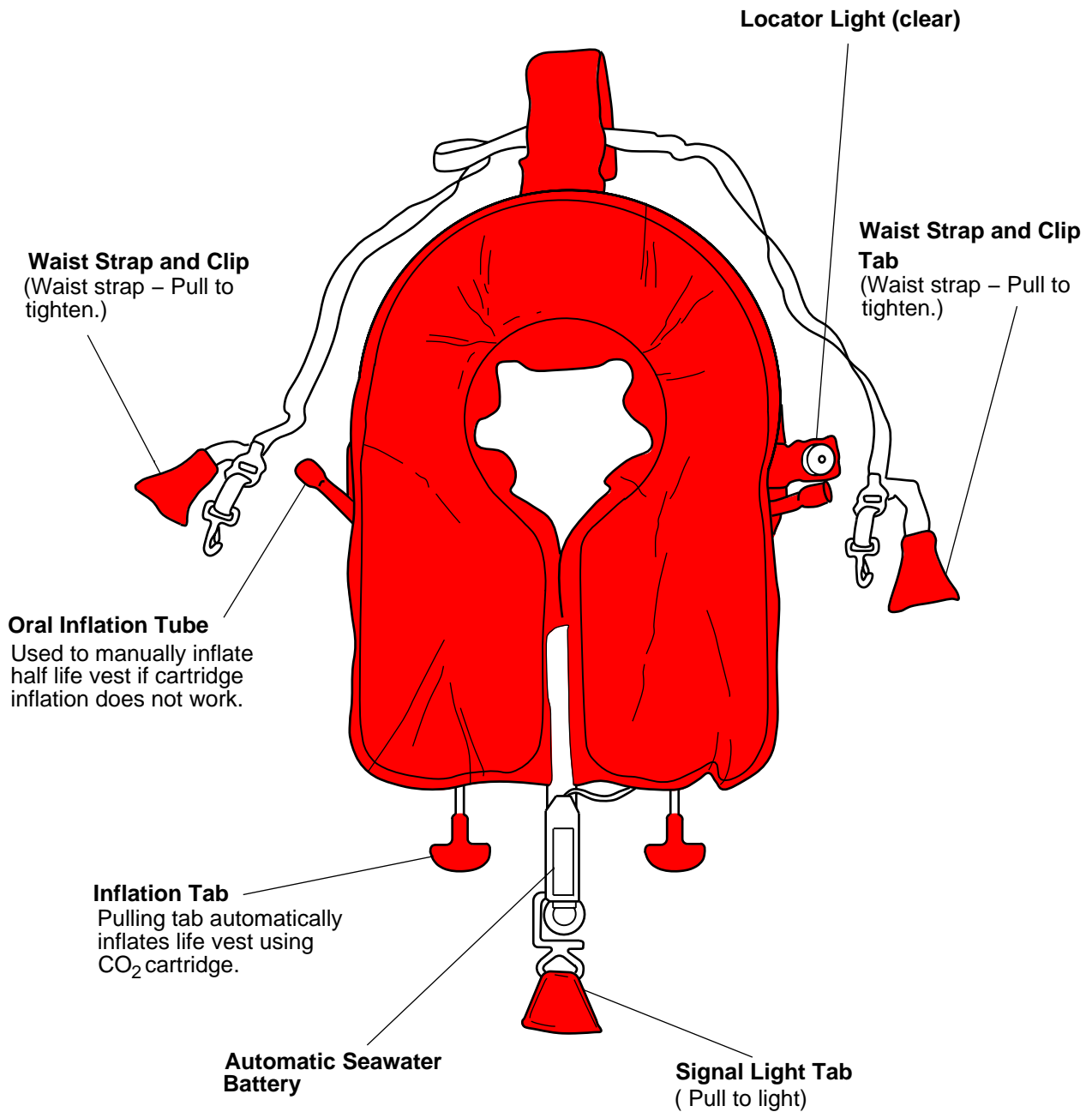

GF0810_023

LIFE VEST (CONT'D)

To don the life vest proceed as follows:

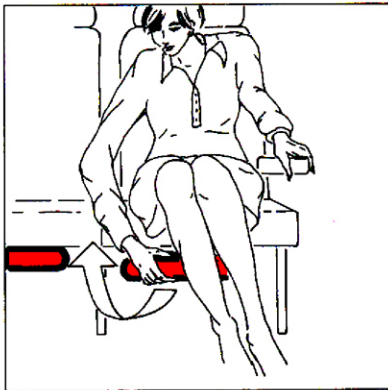

1. Find the life vest under the seat

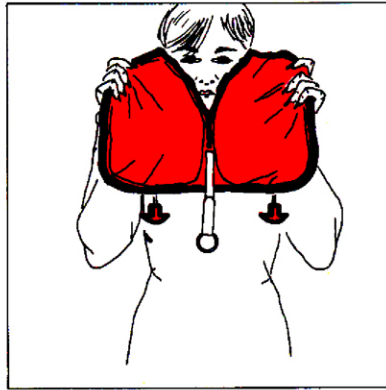

2. Put the life vest over head...

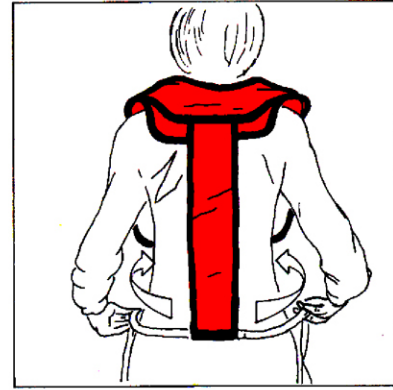

3. ...with the back piece behind.

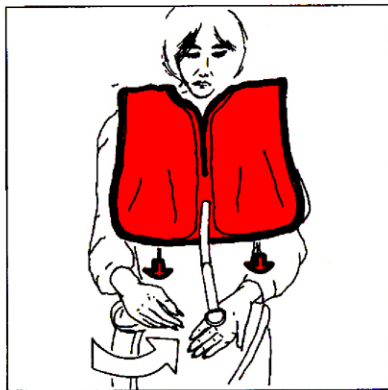

4. Fasten rings to catch

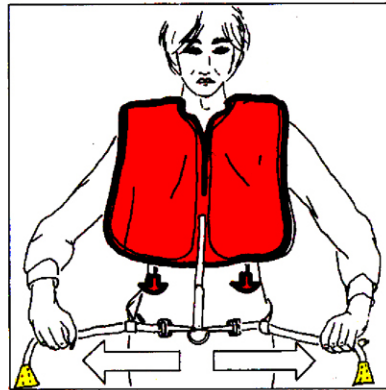

5. Pull straps tight



6. Jerk down on inflation tabs.

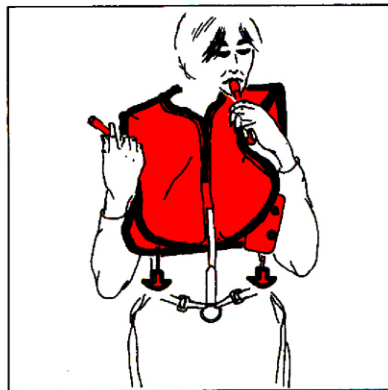

7. Should it become necessary, life vest can be orally inflated by blowing into oral inflation tubes.

**INFLATE LIFE VEST JUST BEFORE JUMPING OUT OF THE AIRPLANE!
USING OVERWING EMERGENCY EXIT INFLATE LIFE VEST WHEN ON THE WING.**

NOTE

- When using the adult/child life vest for children, pass straps between legs, fasten hooks. Inflate only one chamber.

GF0810_024

EMERGENCY EQUIPMENT EMS CIRCUIT PROTECTION

CB - OXYGEN

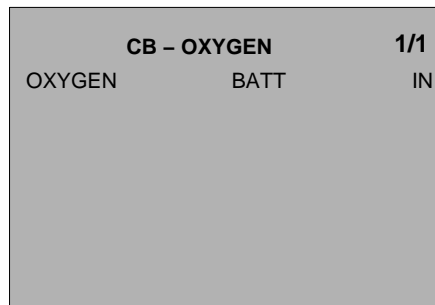
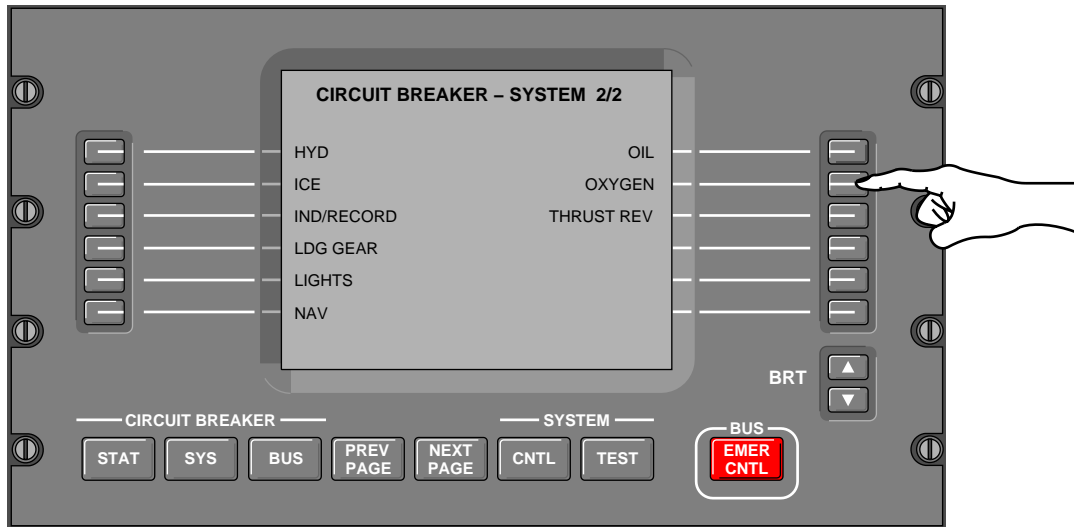

GF0820_001

**EMERGENCY EQUIPMENT
EMS CIRCUIT PROTECTION**

THIS PAGE INTENTIONALLY LEFT BLANK