

FALCON 7X	ATA 33 – LIGHTS GENERAL	02-33-05
CODDE 1		PAGE 1 / 4
DGT97831		ISSUE 2

ACRONYMS LIST

BATT	Battery
CB	Circuit Breaker
EPS	Emergency Power Supply
LED	Light Emitting Diode
LH	Left Hand
MAU	Modular Avionic Unit
OP	Overhead Panel
PPDB	Primary Power Distribution Box
RH	Right Hand
SSPC	Solid State Power Controller

02-33-05	ATA 33 – LIGHTS GENERAL	FALCON 7X
PAGE 2 / 4		CODDE 1
ISSUE 2		DGT97831

INTRODUCTION

The Airplane lighting system provides the following functions:

- For External Lighting:
 - o Illumination of airplane environment (runway, taxiway, parking),
 - o Illumination of airplane structure (wings, refuel area, loading area),
 - o Signalisation of airplane visual position and track (anti collision lights, navigation lights),
- For Interior Lighting:
 - o Required level of cockpit illumination according to crew comfort, environmental condition and phase of flight,
 - o Required level of cabin illumination according to passenger comfort,
 - o Illumination of working area for servicing, maintenance and inspection operation,
 - o (compartments, refueling panel, water filling panel),
- For emergency Lighting:
 - o Signalisation of internal evacuation access and routing (interior emergency lighting),
 - o Signalisation of External evacuation routing (exterior emergency lighting).

The lighting system includes following option:

- External lighting of LOGO.

FALCON 7X	ATA 33 – LIGHTS GENERAL	02-33-05
CODDE 1		PAGE 3 / 4
DGT97831		ISSUE 2

FLIGHT DECK OVERVIEW

CONTROLS

Crew control of the lighting system is performed via:

- The lower part of the cockpit Overhead Panel,
- ON/OFF and brightness control knob next to each dome light,
- ON/OFF and brightness controls on the reading lights themselves,
- The lighting control panel located on the entrance wall upper part,
- The TEST synoptic page for triggering the LIGHT test.

A stair light pushbutton is also available on the door.

Compartments, fuel panel and pylon lighting are automatically activated upon opening of the compartment door.

INDICATIONS

Cockpit indications related to lighting system are displayed on:

- The lower part of the cockpit Overhead Panel for the ordinance signs,
- The ENG-CAS window for CAS messages,
- The STATus synoptic / FAULT tab for fault messages.

02-33-05	ATA 33 – LIGHTS GENERAL	FALCON 7X
PAGE 4 / 4		CODDE 1
ISSUE 2		DGT97831

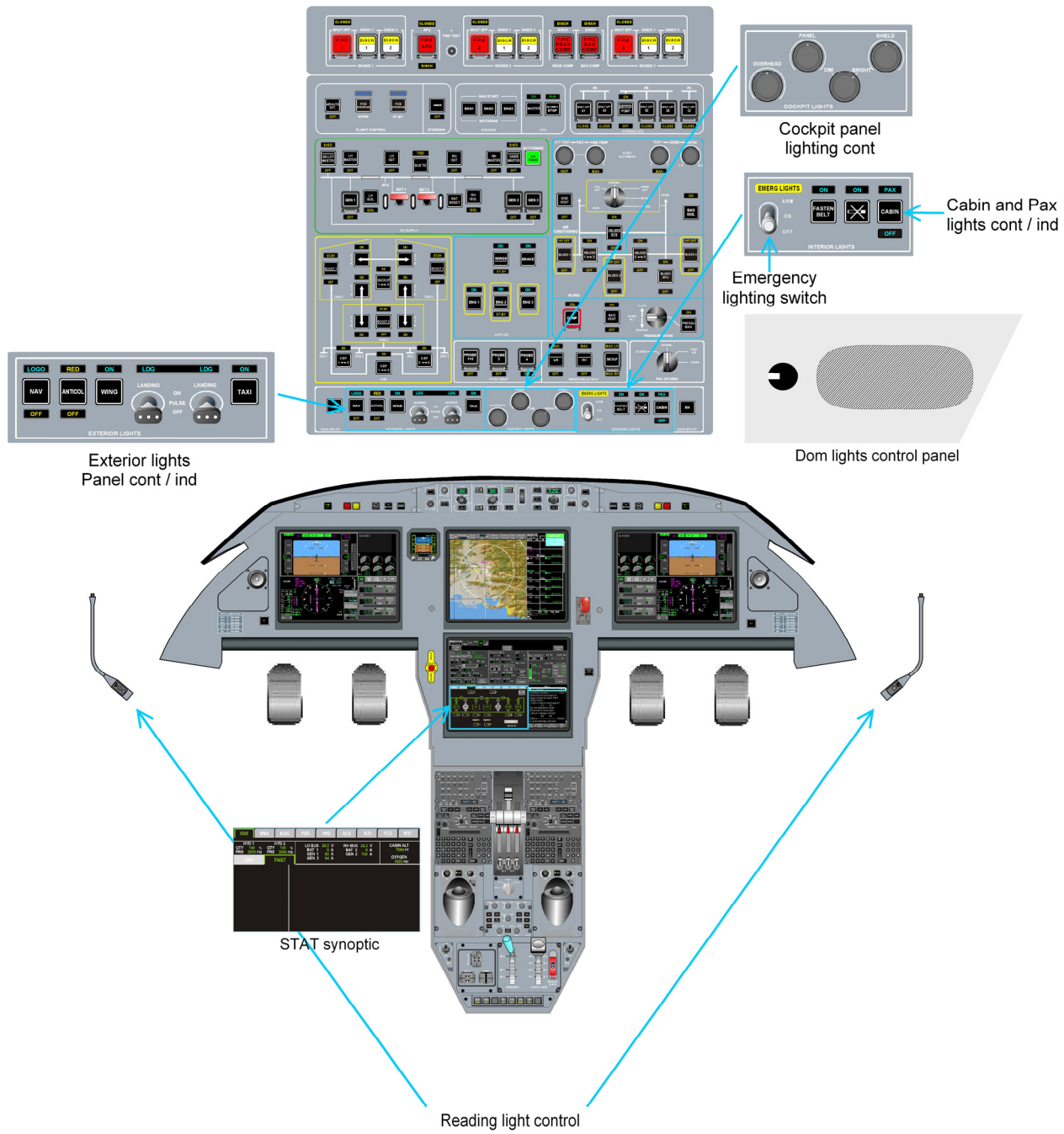

FIGURE 02-33-05-00 – FLIGHT DECK OVERVIEW

FALCON 7X	ATA 33 – LIGHTS DESCRIPTION	02-33-10
CODDE 1		PAGE 1 / 10
DGT97831		ISSUE 2

EXTERIOR LIGHTS

The exterior lighting system includes the following:

- Landing lights,
- Taxi lights,
- Navigation lights,
- Anti collision lights,
- Wing ice detection lights,
- Pylon lights (Ground utility),
- Logo lights.

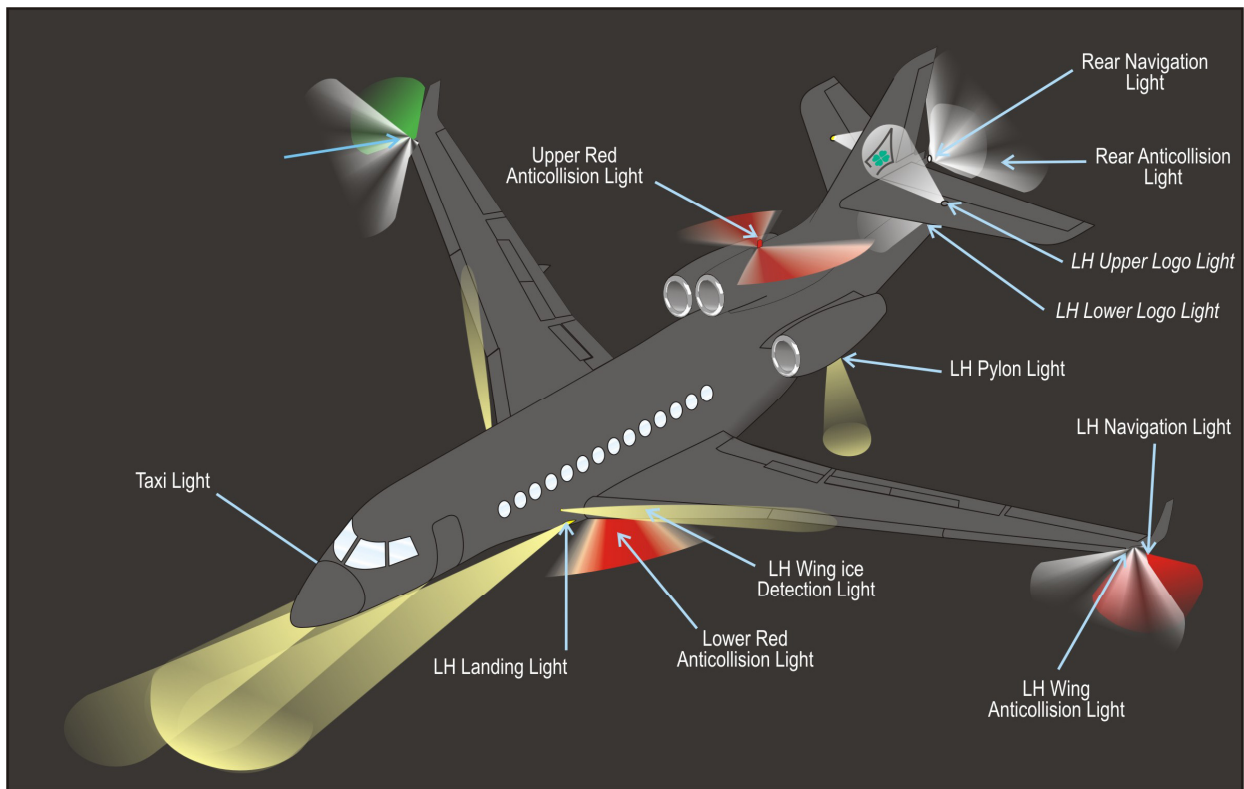

FIGURE 02-33-10-00 - EXTERIOR LIGHTING LOCATION

02-33-10	ATA 33 – LIGHTS DESCRIPTION	FALCON 7X
PAGE 2 / 10		CODDE 1
ISSUE 2		DGT97831

LANDING LIGHTS

Provide ground reference illumination during Take Off, Final Approach and Landing

The two Halogen Landing Lights can be selected to pulse to enhance Anti Collision illumination.

NOTE

Ground operation is limited to a 15 minutes cycle with a 45 minutes cooling period between use.

Taxi light

The taxi light provides illumination for maneuvering the airplane on ground.

The halogen light is located in a non movable part of the nose Landing Gear.

Navigation Lights (wings and rear)

The navigation lights allow an assessment of airplane position, flight direction and airplane orientation relative to an observer.

The Navigation lights system is constituted by:

- Two wing navigation LED lights located in the wing tips (red for LH wing / green for RH wing),
- One rear navigation LED light located in the tail cone (white light).

Anti Collision Lights

Provide on ground and in flight visual airplane position at night or with low visibility conditions.

The Anti Collision lights system is constituted by :

- Two Red Strobe lights located :
 - o One on the bottom part of the body fairing,
 - o One in the upper surface of the S-duct,
- Three White Strobe lights located:
 - o One at each wing tip,
 - o One in the tail cone.

The red anti-collision lights are generally used for ground operation since it minimizes the unfavorable effects on the crew's vision or on staff outside the airplane during ground operation. The white anti-collision lights are used during the flight in addition to the red ones.

FALCON 7X	ATA 33 – LIGHTS DESCRIPTION	02-33-10
CODDE 1		PAGE 3 / 10
DGT97831		ISSUE 2

Wing ice detection lights

Provide sufficient illumination of the last 7 meters of the wings to help in ice formation evaluation.

The wing ice detection lighting is constituted by two halogen lights located on the body fairing.

Pylon (ground utility) lights

The pylon halogen lights provide illumination to allow operation around the baggage compartment door on the left hand side and around the fuel compartments (fueling panel and refueling connector) on the right hand side.

Pylon lights are located underneath engine pylons to provide illumination around:

- The baggage compartment door (left hand side),
- The refuel panel and connector (right hand side).

Logo lights

Logo lights provide illumination on the customer logo painted on the vertical fin.

They are located on the horizontal empennage:

- 2 upper logo lights are basic,
- 2 lower logo lights are optional.

02-33-10	ATA 33 – LIGHTS DESCRIPTION	FALCON 7X
PAGE 4 / 10		CODDE 1
ISSUE 2		DGT97831

INTERIOR LIGHTS

The interior lighting system is divided in three sub-systems:

- Cockpit lighting,
- Cabin lighting,
- Compartment lighting.

COCKPIT LIGHTING

The cockpit lighting provides the required illumination to the crew members under all external lighting conditions in order to read instrumentation, placards, check lists, manuals, maps, instrument color coding, distinguish control without undue interference (reflection, glare, direct light).

The cockpit lighting includes the following equipment:

- Dome lights,
- Reading lights,
- Shield lights,
- Lighting controller.

Dome lights

The general illumination of the cockpit is provided by two dome lights.

They are located beside the overhead panel:

- One on the left side,
- One on the right side.

Each dome light has an ON/OFF and brightness control.

Reading lights

The reading LED lights give the required illumination to allow the crew reading maps or manuals.

Three reading lights are installed in the cockpit:

- One for the pilot,
- One for the co-pilot,
- One for the third crew member.

Each light features its own ON/OFF and brightness control.

Shield lights

The illumination of the main instrument panel is provided by two shield lights located under the glare shield.

FALCON 7X	ATA 33 – LIGHTS DESCRIPTION	02-33-10
CODDE 1		PAGE 5 / 10
DGT97831		ISSUE 2

Lighting controller

The Lighting controller provides the dimming control for:

- The shield lights
- The panels integrated lighting
- The push button lighting

CABIN LIGHTING

The cabin lighting includes:

- Stairs lighting,
- Entry lights,
- Aisle lights,
- Passengers lights.

Only passenger door stairs lighting is considered in this document as basic (other cabin lighting will be part of completion furniture).

Stairs lighting

The main entry door stairs lighting is provided by five step lights. Each step has one light.

The step lights are controlled either through the lighting control panel "STAIR LIGHTS" switch/light located in the main entrance or by a pushbutton located on the stair.

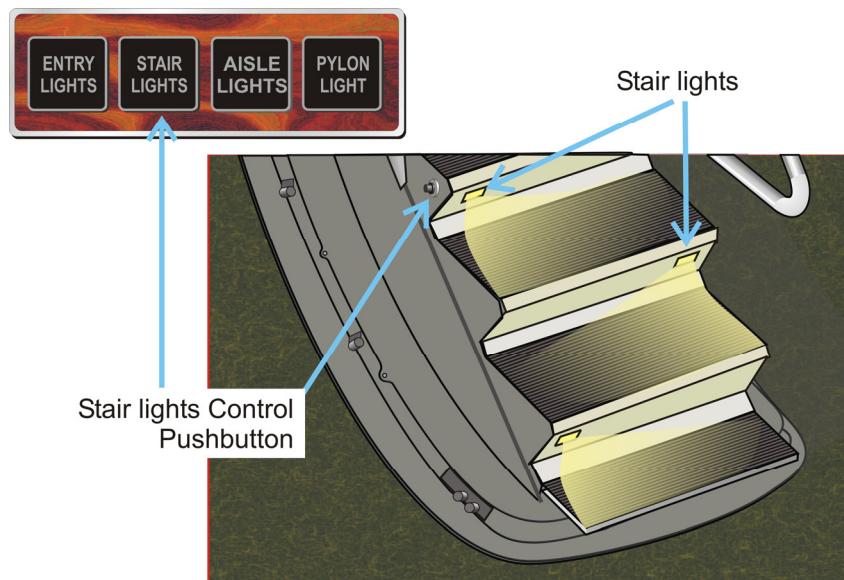

FIGURE 02-33-10-01 - STAIR LIGHTING

02-33-10	ATA 33 – LIGHTS DESCRIPTION	FALCON 7X
PAGE 6 / 10		CODDE 1
ISSUE 2		DGT97831

COMPARTMENT LIGHTING

The compartment lighting provides the necessary illumination of the work areas for general servicing, maintenance and inspection purposes.

The areas requiring lighting are:

- The nose cone,
- The baggage compartment,
- The rear compartment,
- The refueling panel,
- The water filling compartment.

Nose cone light

Nose cone lighting is provided by a hand inspection light.

The light consists of a LED circuit with its own hand ON/OFF switch on the body housing.

A 10 min timer automatically switches the hand light off.

Baggage compartment lighting

The Baggage compartment lighting is provided by two ceiling lights.

These ceiling lights are lighted either upon opening of the exterior baggage compartment door or upon opening of the compartment interior door (microswitches).

Rear compartment lighting

The rear compartment lighting is provided by two ceiling lights. These ceiling lights are activated upon opening of the compartment door (microswitch).

Refueling panel lighting

The refueling panel lighting is provided by two servicing lights.

These servicing lights are activated, on the ground, upon opening of the compartment exterior door (microswitch).

Water filling compartment lighting

The water filling compartment lighting is provided by one servicing light.

This servicing light is activated, on the ground, upon opening of the compartment exterior door (micro switch).

FALCON 7X	ATA 33 – LIGHTS DESCRIPTION	02-33-10
CODDE 1		PAGE 7 / 10
DGT97831		ISSUE 2

EMERGENCY LIGHTS

The emergency lighting system is provided to allow passengers and crew to safely evacuate the airplane after an emergency landing or ditching.

The emergency lighting system includes the following lights:

- General cockpit illumination,
- Passenger door lighting,
- Exit signs,
- Exterior emergency lighting.

In case of total electrical failure, the electrical power for the emergency lights is supplied by 3 battery packs referred to as Emergency Power Supply (EPS).

GENERAL COCKPIT ILLUMINATION

The emergency general illumination of the cockpit is provided by two Dome lights.

PASSENGER DOOR LIGHTING

Two LED spotlights provide the illumination of the passenger door in an emergency situation.

They are located on the top of the passenger door frame.

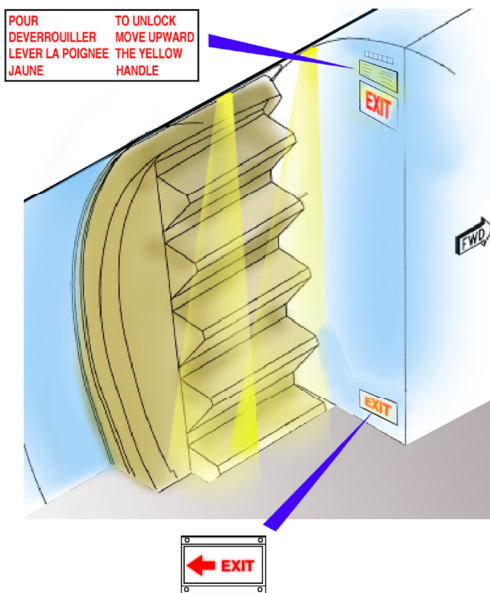

FIGURE 02-33-10-02 - PASSENGER DOOR LIGHTING

02-33-10	ATA 33 – LIGHTS DESCRIPTION	FALCON 7X
PAGE 8 / 10		CODDE 1
ISSUE 2		DGT97831

EXIT SIGNS

The exit signs include:

Front / Passenger door

One main exit sign located on the entrance wall trim upper part.

One floor exit sign with a horizontal label located on the entrance wall lower part.

Rear / Emergency exit

One dual exit sign located above the emergency exit door. It is readable from anywhere in the airplane cabin.

One floor exit sign with a vertical label located under the emergency exit door.

One "Pull here to open" sign located on the emergency exit to indicate the way to open the emergency exit.

One handle light located in the emergency exit to illuminate the door handle part.

FALCON 7X	ATA 33 – LIGHTS DESCRIPTION	02-33-10
CODDE 1		PAGE 9 / 10
DGT97831		ISSUE 2

EXTERIOR EMERGENCY LIGHTING

The exterior emergency lighting consists of two external emergency lights:

- One located in the body fairing in order to illuminate the escape path on the wing,
- One located in the wing leading edge lower skin in order to illuminate the ground where an evacuee would normally make first contact with the ground.

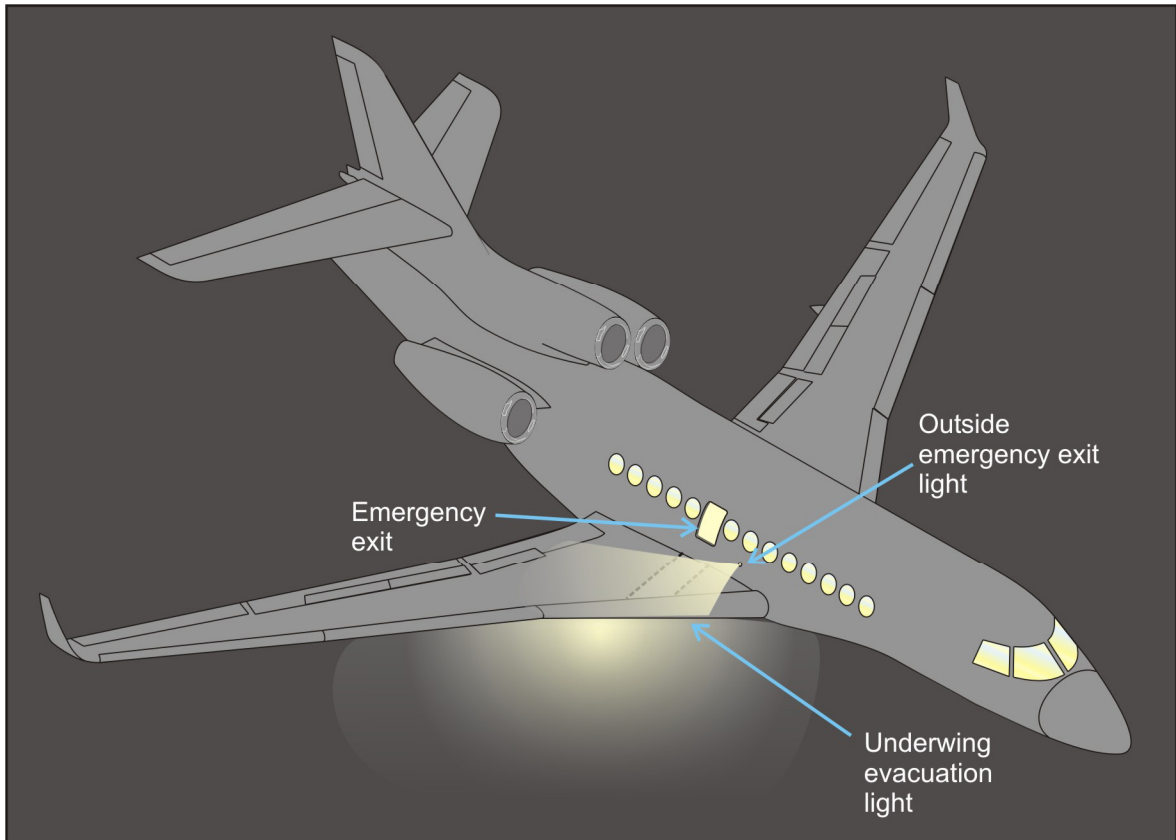

FIGURE 02-33-10-03 - EXTERIOR EMERGENCY LIGHTS

FALCON 7X	ATA 33 – LIGHTS DESCRIPTION - SUPPLEMENTARY INFORMATION	02-33-15
CODDE 1		PAGE 1 / 8
DGT97831		ISSUE 2

DESIGN PRINCIPLE

The Lighting system was designed considering the following design principles:

- With regard to Safety:
 - o Use of LED circuit minimizes the fire hazard. In addition, polycarbonate glazing is fire resistant.
 - o Ceiling lights (baggages compartment, rear compartment) are protected with a grid to avoid any damage during operation in the compartment and prevent contact with cargo loads.
- With regard to efficiency:
 - o The landing light and taxi light are installed so that no objectionable glare is visible to the pilots,
 - o The landing lights pulse operation improves anti collision,
 - o Red anti collision lights minimize unfavorable effects on crew or ground staff vision.
- With regard to maintenance:
 - o For equipment which are not installed near an access door, an over length has been foreseen either on electrical wiring or directly on the equipment to allow inspection or replacement,
 - o A LED lighting level detector allows detection of a lighting performance decrease for navigation lights.

02-33-15	ATA 33 – LIGHTS DESCRIPTION - SUPPLEMENTARY INFORMATION	FALCON 7X
PAGE 2 / 8		CODDE 1
ISSUE 2		DGT97831

EQUIPMENT LOCATION

➤ Refer to section 33-10 for location of exterior lights.

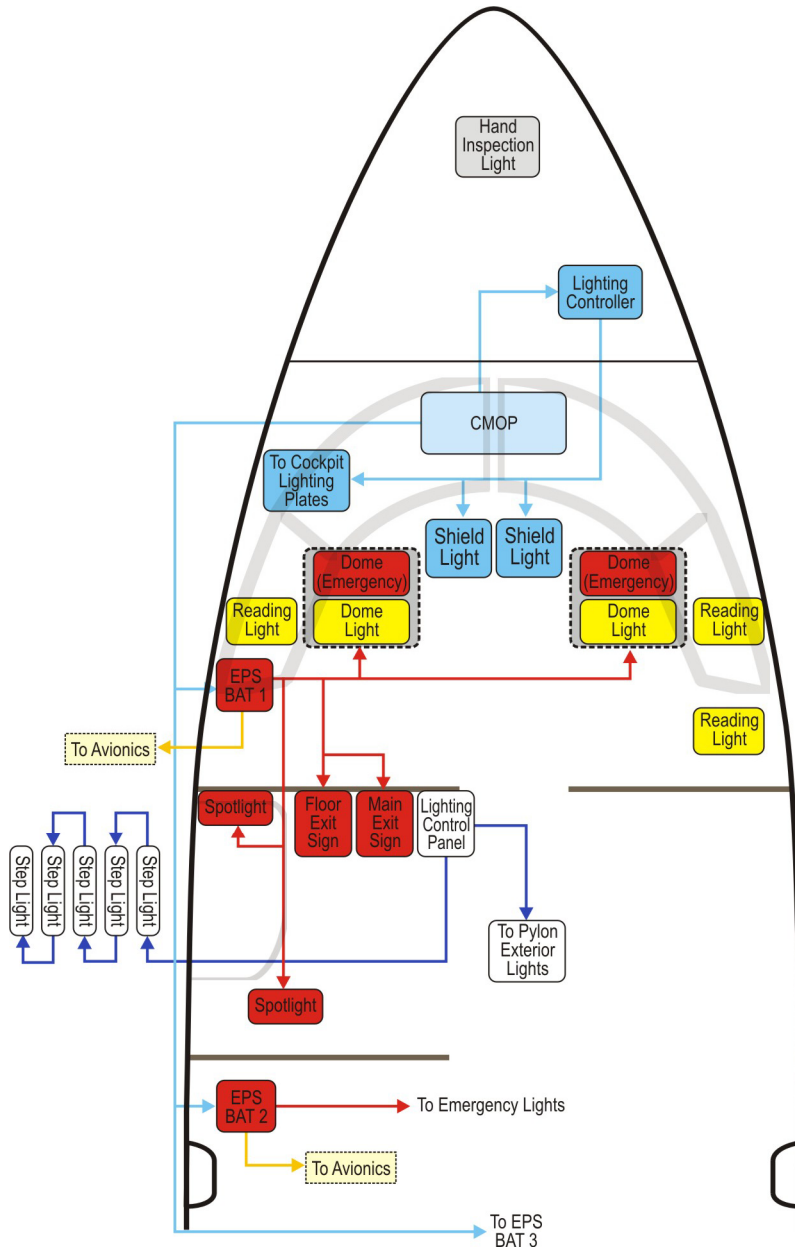

FIGURE 02-33-15-00 - EMERGENCY & INTERIOR LIGHTS

FALCON 7X	ATA 33 – LIGHTS DESCRIPTION - SUPPLEMENTARY INFORMATION	02-33-15
CODDE 1		PAGE 3 / 8
DGT97831		ISSUE 2

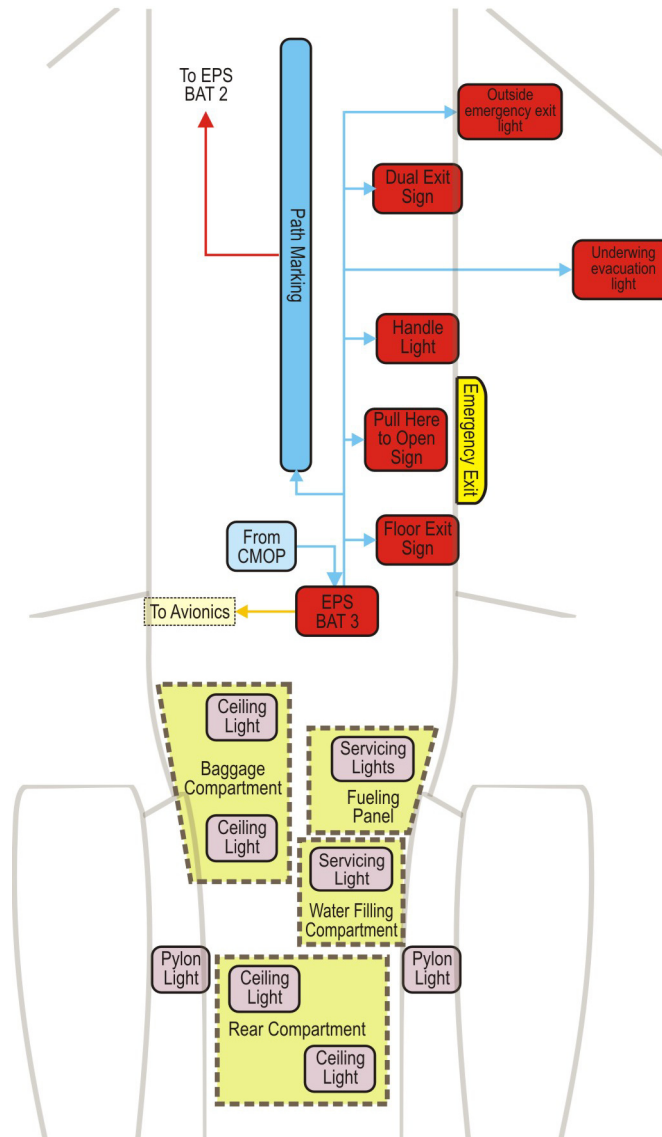

FIGURE 02-33-15-01 - EMERGENCY & INTERIOR LIGHTS

02-33-15	ATA 33 – LIGHTS DESCRIPTION - SUPPLEMENTARY INFORMATION	FALCON 7X
PAGE 4 / 8		CODDE 1
ISSUE 2		DGT97831

ELECTRICAL POWER SUPPLY

Following paragraph describes the power supply and electrical protection of the different equipment of the lighting system.

Electrical protection is provided:

- By Solid State Power Controllers (SSPC),
 - By Circuit Breakers (CB),
 - By relays.
- Refer to ATA 24 – ELECTRICAL POWER for additional information.

EXTERIOR & INTERIOR NORMAL LIGHTING

EQUIPMENT	POWER SUPPLY	TYPE OF PROTECTION
LH Landing light	LH Main bus	CB
RH Landing light	RH Main bus	CB
Taxi light	RH Main bus	CB
LH Navigation light	LH Main bus	SSPC
RH Navigation light	RH Main bus	CB
Rear Navigation light	RH Main bus	CB
LH white anticollision light	LH Main bus	CB
RH white anticollision light	RH Main bus	CB
Rear white anticollision light	LH Main bus	SSPC
Upper Red anticollision light	LH Essential bus	SSPC
Lower Red anticollision light	RH Main bus	SSPC
LH wing ice detection light	LH main bus	CB
RH wing ice detection light	RH Main bus	CB
LH Upper logo light	RH Main bus	SSPC
RH upper logo light	RH Main bus	SSPC

FALCON 7X	ATA 33 – LIGHTS DESCRIPTION - SUPPLEMENTARY INFORMATION	02-33-15
CODDE 1		PAGE 5 / 8
DGT97831		ISSUE 2

EQUIPMENT	POWER SUPPLY	TYPE OF PROTECTION
LH lower logo light (optional)	RH Main bus	SSPC
RH lower logo light (optional)	RH Main bus	SSPC
Dome lights (normal lighting) Step lighting Nose cone lighting Baggage compartment lighting Rear compartment lighting Refueling panel lighting Water filling compartment lighting Ground Utility lighting (Pylon)	RH Battery bus	CB
Reading light (pilot)	LH Main bus	CB
Reading light (copilot and third crew)	RH Main bus	CB
Shield lights, panells lights and pushbuttons lights through lighting controller	RH Main bus (Shield lights) LH Main bus (Panels and pushbuttons)	CB

02-33-15	ATA 33 – LIGHTS DESCRIPTION - SUPPLEMENTARY INFORMATION	FALCON 7X
PAGE 6 / 8		CODDE 1
ISSUE 2		DGT97831

EMERGENCY LIGHTING

EQUIPMENT	POWER SUPPLY	TYPE OF PROTECTION
General cockpit illumination (Dome lights) Passenger door lighting Exit Signs Exterior Emergency lighting	RH & LH Main bus 6Vdc EPS Battery (*)	CB

(*) - In case of total electrical failure, the electrical power for all the emergency lights is supplied by three self-contained battery power supply units (Emergency Power Supply) providing 6VDC output to the emergency lighting at the maximum capacity rate of 2,2 Ah.

FALCON 7X	ATA 33 – LIGHTS DESCRIPTION - SUPPLEMENTARY INFORMATION	02-33-15
CODDE 1		PAGE 7 / 8
DGT97831		ISSUE 2

MAIN COMPONENTS DESCRIPTION

ANTI COLLISION LIGHTS

The anti-collision light system use flash tube technology.

The two wing anti-collision lights with reflector focusing lighting, one at each wing tip, are installed behind the wing tip glazing and the rear anti-collision light installed in the tail cone with no glazing. They provide illumination in each direction within 75° above and 75° below the horizontal plane of the airplane without obstructed visibility.

COCKPIT LIGHTING

Dome lights

Each dome light has two separate LED circuits with their own specific connector:

- One for normal lighting,
- One for emergency lighting.

Reading lights

Three lights are installed in the cockpit, one for the left pilot, one for the right pilot and one for the third crewmember.

Shield lights

The illumination of the main instrument panel is provided by two shield lights. Both are located under the glare shield.

COMPARTMENT LIGHTING

Nose cone light

Nose cone lighting is provided by a hand inspection light. The hand light is removable from the light bracket, allowing inspection of the equipment items located within the nose cone, but remains attached to the airplane thanks to a twisted electrical cord of 1.70 m.

A 10 min timer automatically switches the hand light off.

Baggage compartment lighting

The ceiling lights are protected with a grid to avoid any damage during operation in the compartment.

Each light consist of by a LED circuit.

The polycarbonate glazing is fire resistant. Breakage or failure of equipment is designed to present a fire hazard.

02-33-15	ATA 33 – LIGHTS DESCRIPTION - SUPPLEMENTARY INFORMATION	FALCON 7X
PAGE 8 / 8		CODDE 1
ISSUE 2		DGT97831

EMERGENCY LIGHTING

In case of total electrical failure, the electrical power for all the emergency lights is supplied by self-contained battery power supply units providing 6 VDC output to the emergency lighting at the maximum capacity rate of 2.2 Ah. The battery pack is made of 5 sealed Nickel-Cadmium cells in series well adapted for cycling operations. It is supplied by a DC/DC converter. It is a slow charge of 16 h at current set to 0.220 Ah.

There are three battery packs referred to as Emergency Power Supplies (EPS). The units are located in a position where they will continue to provide lighting power in event of a major structural break:

- EPS1 is located between frame 8 and frame 9 under floor on the airplane centerline,
- EPS2 is located in airplane left side at the main entrance on the right,
- EPS3 is located on the airplane right side beside the emergency exit door.

The three EPS are automatically powered from either the LH or RH MAIN BUS according the availability of those buses.

When an EPS detects a low battery or a battery failure a fault message is displayed in STATUS page (EMERG LIGHT: BAT x FAIL, with x =1, 2 or 3).

FALCON 7X	ATA 33 – LIGHTS CONTROLS AND INDICATIONS	02-33-20
CODDE 1		PAGE 1 / 12
DGT97831		ISSUE 2

CONTROLS

Crew control of the lighting system is performed via:

- The lower part of the cockpit Overhead Panel for:
 - o EXTERIOR LIGHTS,
 - o COCKPIT LIGHTS,
 - o Other INTERIOR LIGHTS, including emergency lights.
- ON/OFF and brightness control knob next to each dome lights,
- ON/OFF and brightness controls on the reading lights themselves,
- The lighting control panel located on the entrance wall upper part for:
 - o Entry, stair, and aisle lights,
 - o Pylon light.
- An other stair light pushbutton on the door itself,
- The TEST synoptic page for triggering the LIGHT test.

Compartments and fuel panel lighting is automatically activated upon opening of the compartment door thanks to microswitches.

LIGHTS PANELS

The lower part of the overhead panel is split into three sections described hereafter:

- EXTERIOR LIGHTS,
- COCKPIT LIGHTS,
- INTERIOR LIGHTS.

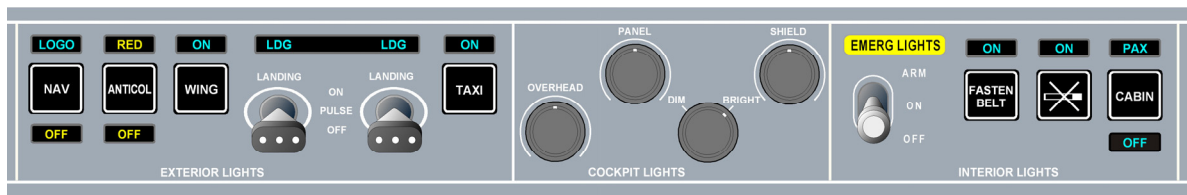

FIGURE 02-33-20-00 - LIGHTS PANELS

EXTERIOR LIGHTS PANEL

Exterior lights control is performed by pushbuttons for:

- Nav lights (logo in option),
- Anticol lights,
- Wing lights,
- Taxi lights.

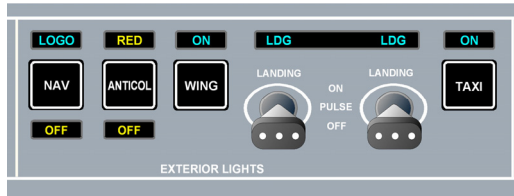













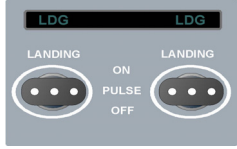





FIGURE 02-33-20-01 - EXTERIOR LIGHTS PANEL

CONTROL	FUNCTION	TO ACTIVATE		
		TO DEACTIVATE		
	<p>Activates navigation and logo lights</p> <p>Pushbutton functions are :</p> <ul style="list-style-type: none"> - OFF: navigation and logo lights off - Unlighted on: navigation lights on, - LOGO: navigation and logo lights on. 	 <p>OFF</p>	 <p>NAV ON</p>	 <p>NAV and LOGO ON</p>
	<p>Activates strobes and red anti-collision lights</p> <p>Pushbutton functions are:</p> <ul style="list-style-type: none"> - OFF: red and white anti-collision lights off - RED: red anti-collision light on, - Unlighted on: red and white anti-collision lights on. 	 <p>OFF</p>	 <p>RED ANTICOL ON</p>	 <p>RED and strobes ANTICOL ON</p>
	<p>Activates left and right wing ice detection lights,</p> <p>Pushbutton functions are: OFF / ON.</p>	 <p>OFF</p>	 <p>ON</p>	

FALCON 7X	ATA 33 – LIGHTS CONTROLS AND INDICATIONS	02-33-20
CODDE 1		PAGE 3 / 12
DGT97831		ISSUE 2

CONTROL	FUNCTION	TO ACTIVATE
		TO DEACTIVATE
	<p>Activates the two landing lights.</p> <p>Pushbutton functions are:</p> <ul style="list-style-type: none"> - OFF: landing lights are turned off, - PULSE: alternatively flashes LH and RH landing lights, - ON: Activates LH and RH landing lights. 	<div style="display: flex; justify-content: space-around;"> <div style="text-align: center;">  OFF </div> <div style="text-align: center;">  ON </div> </div> <div style="text-align: center; margin-top: 20px;">  PULSE </div>
	<p>Activates taxi light</p> <p>Pushbutton functions are: OFF / ON.</p>	<div style="display: flex; justify-content: space-around;"> <div style="text-align: center;">  OFF </div> <div style="text-align: center;">  ON </div> </div>

COCKPIT LIGHTS PANEL

Cockpit lights control is performed by four rotary switches.

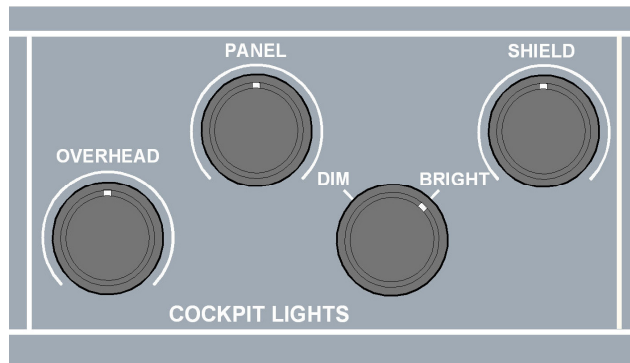

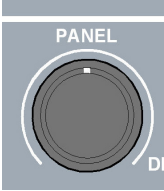
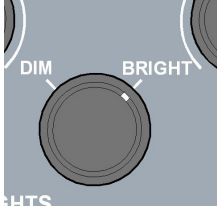
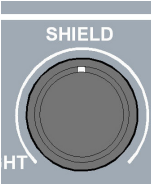

FIGURE 02-33-20-02 - COCKPIT PANEL

02-33-20	ATA 33 – LIGHTS CONTROLS AND INDICATIONS	FALCON 7X
PAGE 4 / 12		CODDE 1
ISSUE 2		DGT97831

CONTROL	FUNCTION
 <p>Counterclockwise</p>  <p>Clockwise</p>	<p>OVERHEAD rotary knob adjusts lighting levels of:</p> <ul style="list-style-type: none"> - The Overhead Panel controls. , <p>OVERHEAD rotary knob functions:</p> <ul style="list-style-type: none"> - Counter clockwise: low lighting level, - Clockwise: high lighting level.
	<p>PANEL rotary knob adjusts lighting levels of:</p> <ul style="list-style-type: none"> - All equipment within the flight deck, - Center pedestal. <p>PANEL rotary knob functions:</p> <ul style="list-style-type: none"> - Counter clockwise: low lighting level, - Clockwise: high lighting level.
	<p>DIM / BRIGHT rotary switch allows night and day light level adjustment for:</p> <ul style="list-style-type: none"> - MASTER WARNING, MASTER CAUTION, - All indicators of the Overhead Panel - Oxygen boxes blinker. <p>DIM / BRIGHT rotary switch functions:</p> <ul style="list-style-type: none"> - Counterclockwise: low lighting level, - Clockwise: high lighting level.
	<p>SHIELD rotary knob adjusts LED power light level under glare shield.</p> <p>SHIELD rotary knob functions:</p> <ul style="list-style-type: none"> - Counterclockwise: low lighting level, - Clockwise: high lighting level.

FALCON 7X	ATA 33 – LIGHTS CONTROLS AND INDICATIONS	02-33-20
CODDE 1		PAGE 5 / 12
DGT97831		ISSUE 2

INTERIOR LIGHTS CONTROL

Interior lights control is performed by pushbuttons for:

- Ordinance signs (no smoking, FASTEN BELT),
- Cabin and pax lights.

The emergency lighting control is performed by an ON/OFF/ARM toggle switch.

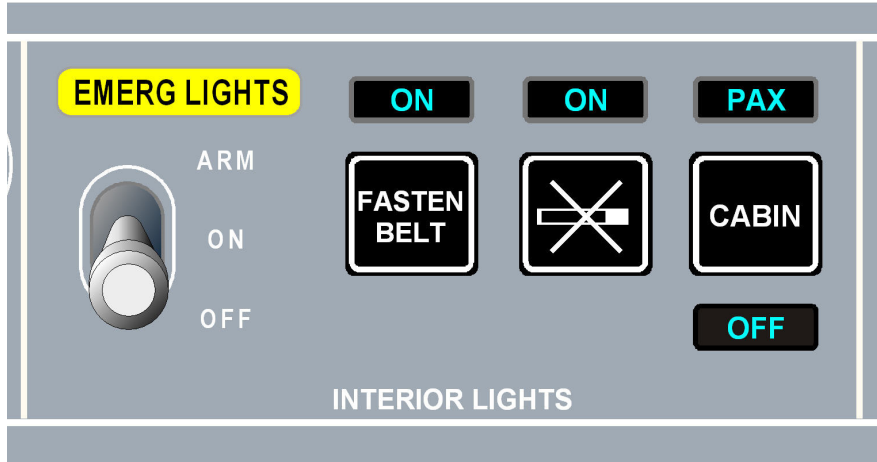

















FIGURE 02-33-20-03 - INTERIOR LIGHTS PANEL

02-33-20	ATA 33 – LIGHTS CONTROLS AND INDICATIONS	FALCON 7X
PAGE 6 / 12		CODDE 1
ISSUE 2		DGT97831

SYNTHETIC TABLE

CONTROL	FUNCTION	TO ACTIVATE		
		TO DEACTIVATE		
	<p>Turns on or arms emergency lights</p> <p>Pushbutton functions are: OFF / ON / ARM</p> <ul style="list-style-type: none"> - ARM position (normal in-flight position), the emergency power supply is automatically activated in case of LH and RH MAIN Bus loss, - ON position: the emergency lighting system is energized with power from emergency batteries, <p>The emergency toggle light is illuminated when the toggle switch is on 'ON' or 'OFF' position.</p>	 <p style="text-align: center;">OFF</p>	 <p style="text-align: center;">ON</p>	 <p style="text-align: center;">ARM</p>
	<p>Illuminates FASTEN SEAT BELT ordinance signs in the cabin area.</p> <p>Pushbutton functions are: OFF / ON.</p>	 <p style="text-align: center;">OFF</p>	 <p style="text-align: center;">ON</p>	

FALCON 7X	ATA 33 – LIGHTS CONTROLS AND INDICATIONS	02-33-20
CODDE 1		PAGE 7 / 12
DGT97831		ISSUE 2

CONTROL	FUNCTION	TO ACTIVATE		
		TO DEACTIVATE		
	Illuminates  ordinance signs in the cabin area. Pushbutton functions are: OFF / ON.	 OFF	 ON	
	Activates entry and passengers lights Pushbutton functions are: <ul style="list-style-type: none"> - OFF: entry and passenger lights off. - Unlighted on: all cabin lights on (entry and passenger lights). - PAX: entry lights off and passenger lights on. 	 OFF	 ALL CABIN LIGHTS ON	 PAX ON AND ENTRY OFF

DOME LIGHTS CONTROL

Dome lights are controlled by ON/OFF and brightness control knob located next to each dome lights.



FIGURE 02-33-20-04 - DOME LIGHT

02-33-20	ATA 33 – LIGHTS CONTROLS AND INDICATIONS	FALCON 7X
PAGE 8 / 12		CODDE 1
ISSUE 2		DGT97831

READING LIGHTS CONTROL

Reading lights are turned ON/OFF and adjusted for brightness with a control on the reading lights themselves.

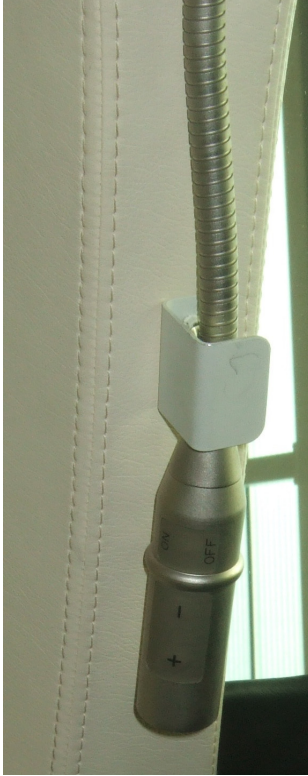

FIGURE 02-33-20-05 - READING LIGHT CONTROL

FALCON 7X	ATA 33 – LIGHTS CONTROLS AND INDICATIONS	02-33-20
CODDE 1		PAGE 9 / 12
DGT97831		ISSUE 2

ENTRANCE LIGHTING CONTROL PANEL

The Lighting Control Panel is located on the entrance wall upper part.



FIGURE 02-33-20-06 - LIGHTS CONTROL PANEL

CONTROL	FUNCTION
ENTRY LIGHTS	Switch/light, including its own indicator light controls the main entry lights.
STAIR LIGHTS	Switch/light, including its own indicator light controls the stair lights.
AISLE LIGHTS	Switch/light, including its own indicator light controls the aisle lights.
PYLON LIGHT	Switch/light, including its own indicator light, controls left and right pylon lights (ground utility lighting).

Pylon lights are also automatically turned on:

- Upon opening of the baggage compartment door through a microswitch,
- Upon opening of the fueling panel door through a microswitch.

02-33-20	ATA 33 – LIGHTS CONTROLS AND INDICATIONS	FALCON 7X
PAGE 10 / 12		CODDE 1
ISSUE 2		DGT97831

TEST SYNOPTIC PAGE

Lights test is triggering through the TEST synoptic.

Lights test allows testing all the following lights:

- Overhead panel,
- Guidance Panel,
- Master caution,
- Master warning,
- Emergency Panel,
- 115/230 VAC pushbutton.

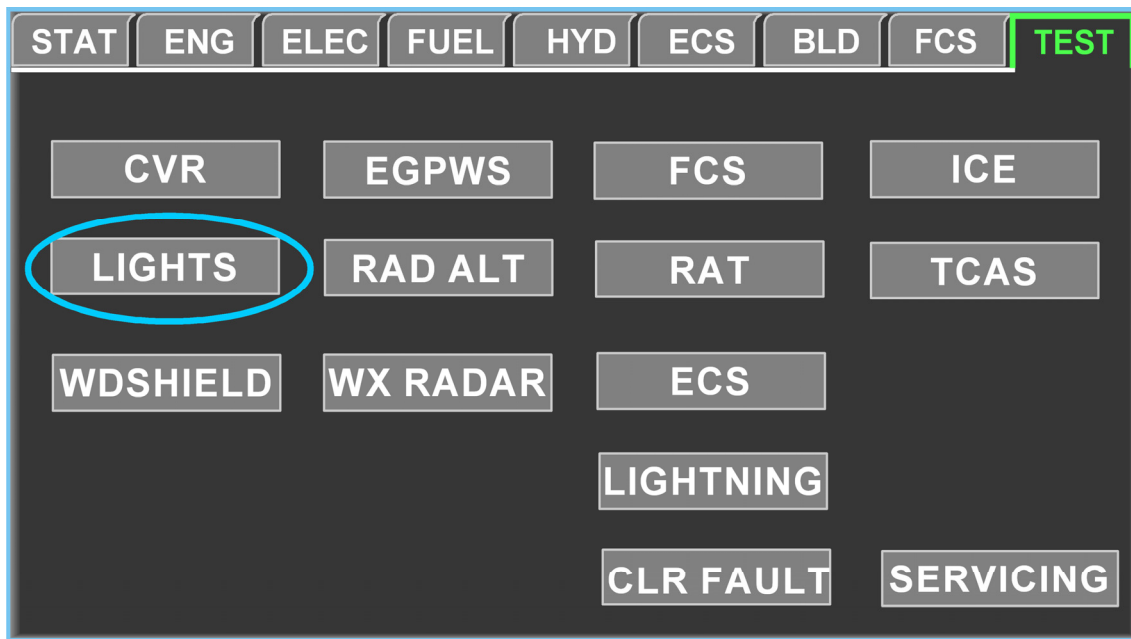

FIGURE 02-33-20-07 - TEST SYNOPTIC

FALCON 7X	ATA 33 – LIGHTS CONTROLS AND INDICATIONS	02-33-20
CODDE 1		PAGE 11 / 12
DGT97831		ISSUE 2

INDICATIONS

Cockpit indications related to lighting system are displayed on:

- The lower part of the cockpit Overhead Panel which provides system feedback for the ordinance signs (no smoking, FASTEN BELT),
- The ENG-CAS window for CAS messages,
- The STATus synoptic / FAULT tab for fault messages.

FALCON 7X	ATA 33 – LIGHTS CONTROLS AND INDICATIONS SUPPLEMENTARY INFORMATION	02-33-25
CODDE 1		PAGE 1 / 2
DGT97831		ISSUE 2

No supplementary information to be provided on controls and indications at present time.

FALCON 7X	ATA 33 – LIGHTS PROTECTIONS	02-33-30
CODDE 1		PAGE 1 / 2
DGT97831		ISSUE 2

SYSTEM MONITORING

Following lighting system parameter is monitored:

- Emergency Power Supply Low Battery.
- *Refer to CODDE 2 for the list of associated fault messages.*

02-33-30	ATA 33 – LIGHTS PROTECTIONS	FALCON 7X
PAGE 2 / 2		CODDE 1
ISSUE 2		DGT97831

ACTIVE PROTECTIONS

Active protection is provided by a thermistor placed within each EPS to detect abnormal heat increase. In this case, the battery is disconnected within the EPS to avoid overheating.

FALCON 7X	ATA 33 – LIGHTS PROTECTIONS SUPPLEMENTARY INFORMATION	02-33-35
CODDE 1		PAGE 1 / 2
DGT97831		ISSUE 2

No supplementary information to be provided on protection at present time.

FALCON 7X	ATA 33 – LIGHTS GROUND OPERATION	02-33-40
CODDE 1		PAGE 1 / 2
DGT97831		ISSUE 2

Lighting system does not require any ground operation.

➤ *Refer to Ground Servicing manual.*