

**TABLE OF CONTENTS**

|   | <b>Page</b> |
|---|-------------|
| Introduction .....  | 16-1        |
| Description .....   | 16-2        |
| Audio Control Panel .....                                 | 16-2        |
| Radio Management Unit (RMU).....                          | 16-2        |
| Global Positioning System (GPS) .....                     | 16-3        |
| Modes of Operation.....                                   | 16-5        |
| GPS Schematic.....  | 16-9        |
| Navigation Display Unit (if installed).....               | 16-10       |
| ON Key.....   | 16-10       |
| Data Entry Keyboard.....                                  | 16-11       |
| Special Function Keyboard .....                           | 16-11       |
| System Select Keys .....                                  | 16-11       |
| Data Select Keyboard .....                                | 16-12       |
| Displays.....   | 16-12       |
| NDU Update.....   | 16-13       |
| Position Entry .....                                      | 16-14       |
| NDU Schematic.....  | 16-16       |
| Inertial Reference System.....                            | 16-17       |
| Laseref IV Differences.....                               | 16-21       |
| Weather Radar (WX).....                                   | 16-22       |
| Radar Antenna .....                                       | 16-23       |
| Mode Selection .....                                      | 16-24       |
| WX System Operation.....                                  | 16-26       |
| Tilt .....  | 16-29       |
| Tilt Management .....                                     | 16-29       |
| Lightning Sensor System (LSS) (if installed).....         | 16-33       |
| Weather Radar Schematic.....                              | 16-34       |
| Traffic Alert and Collision Avoidance System (TCAS) ..... | 16-35       |
| Target/Threat Advisories.....                             | 16-35       |
| Traffic Identification .....                              | 16-36       |
| TCAS Modes.....   | 16-37       |
| ATC/TCAS Mode Select .....                                | 16-37       |
| TCAS DSPY 1 (2) Select .....                              | 16-39       |
| TCAS Mode Select Annunciation.....                        | 16-39       |
| TCAS Symbology.....                                       | 16-40       |
| Digitized Voice .....                                     | 16-40       |
| Resolution Advisories.....                                | 16-41       |
| TCAS Status Messages.....                                 | 16-42       |
| TCAS Zoom Window.....                                     | 16-42       |
| TCAS Traffic Display (MAP Format) .....                   | 16-43       |
| TCAS Schematic.....                                       | 16-44       |
| Enhanced Ground Proximity Warning System (EGPWS).....     | 16-45       |

## Bombardier Global Express - Navigation

|   |       |
|---|-------|
| EGPWS Modes .....                       | 16-47 |
| Terrain Awareness Alerting .....        | 16-57 |
| Annunciations .....                     | 16-59 |
| Terrain Clearance Floor (TCF) .....     | 16-60 |
| Flight Management System (FMS) .....    | 16-61 |
| FMS Display Unit .....                  | 16-61 |
| Annunciators .....                      | 16-62 |
| Brightness Control .....                | 16-63 |
| Line Select Keys .....                  | 16-64 |
| Legend .....                            | 16-65 |
| Function Keys .....                     | 16-66 |
| Scratchpad .....                        | 16-70 |
| Nav Data Base Verification .....        | 16-72 |
| Flight Plan (Stored) .....              | 16-75 |
| Flight Plan Manual Waypoint Entry ..... | 16-76 |
| Navigation System EICAS Messages .....  | 16-79 |
| EMS Circuit Protection .....            | 16-80 |

## INTRODUCTION

The navigation system includes those units and components which provide the following data to the flight crew:

- Position Systems – Dual VHF navigation systems (providing VOR, LOC, GS and MKR signals), FMS, ADF, DME and ATC transponder systems
- Independent Position Systems – Weather radar, TCAS

The navigation receivers are tuned by the Radio Management Units (RMU) and navigation data is displayed on the PFDs and MFDs.

MFD control panels (located on the pedestal) permit control over MFD format. PFD control panels (located on the glareshield) permits control over navigation source and bearing source display.

The partial compass rose on the PFDs echoes the MFD bearing information for the navigation aid selected on the PFD control panel and tuned by the RMUs.

VOR, DME, ADF and MKR audio selection and monitoring is provided at the audio control panels (located on the pedestal).



FMS

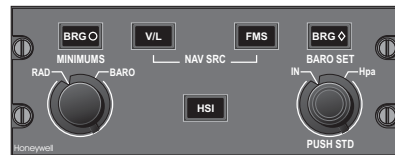

PFD CONTROL PANEL

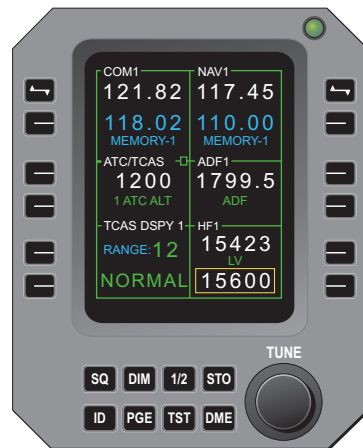

RMU

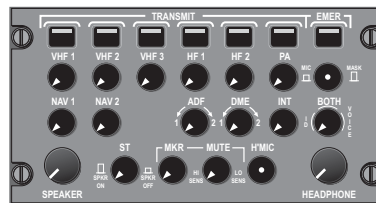

AUDIO CONTROL PANEL



MFD CONTROL PANEL

GX\_16\_001

## DESCRIPTION

### AUDIO CONTROL PANEL

The audio control panels, located on the pedestal, are used to transmit on various radios as selected on the RMU and/or to receive NAV, ADF, DME and MKR information, as selected on the RMU. For more information, see Chapter 5, COMMUNICATIONS.

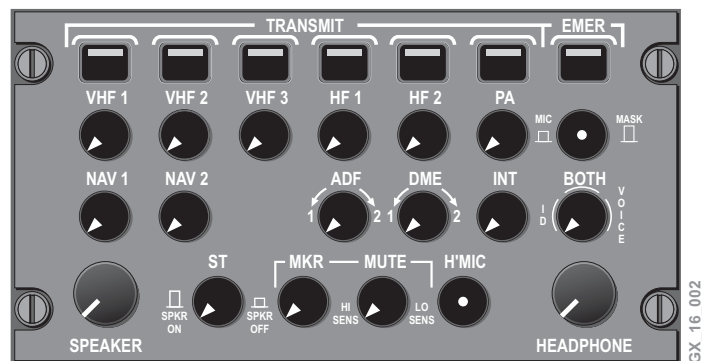

### RADIO MANAGEMENT UNIT (RMU)

Each RMU contains the following functional modules:

- Integrated Navigation Unit
  - VHF NAV Transceiver Module
  - DME Transceiver Module
  - ADF Receiver Module
- Integrated Communication Unit
  - VHF COM Transceiver Module
  - Mode S Transponder Module
  - TCAS Interface Module

Any selectable parameter, such as VOR or ADF frequency, may be changed by pressing the corresponding line key, then by rotating the tuning knobs to set a desired value. For more information, see Chapter 5, COMMUNICATIONS.

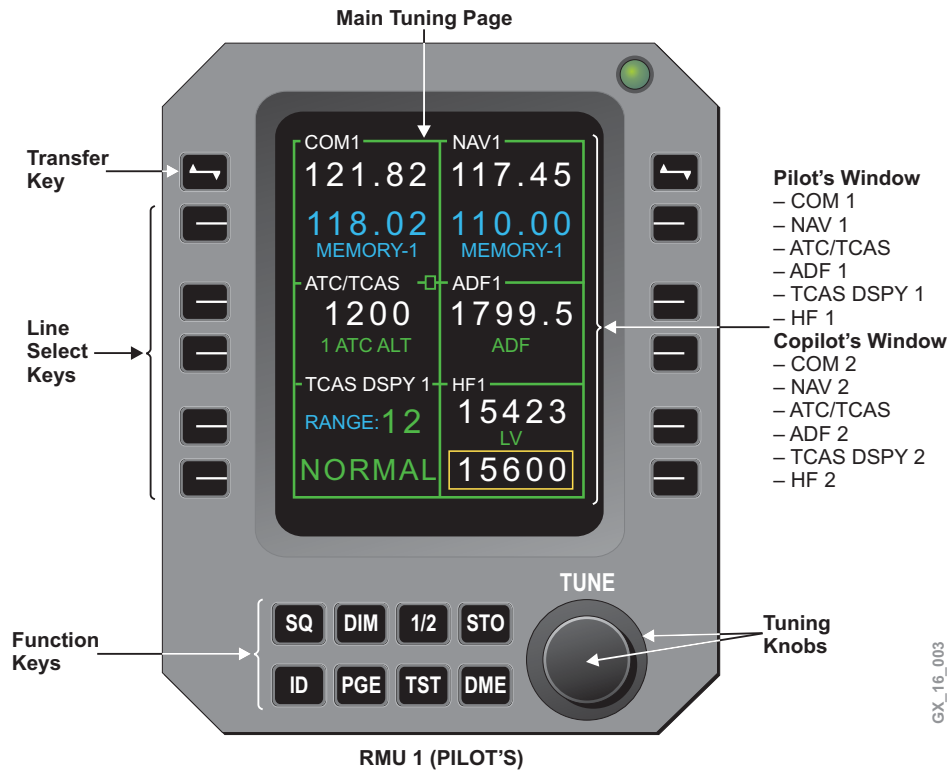

## GLOBAL POSITIONING SYSTEM (GPS)

The GPS provides navigation data to FMS and EGPWS. The GPS calculates the:

- Latitude
- Longitude
- Altitude
- Accurate time
- North/South velocity
- East/West velocity
- Track angle
- Autonomous integrity limit
- Satellite position
- GNSSU status

The Global Navigation System Sensor Unit (GNSSU), is a GPS receiver that receives satellite signals from the NAVSTAR GPS satellite constellation (21 operational satellites and 3 active spares), and uses the satellite data to compute the airplane position. GPS has an accuracy of 100 meters in 95% of the position fixes.

## Bombardier Global Express - Navigation

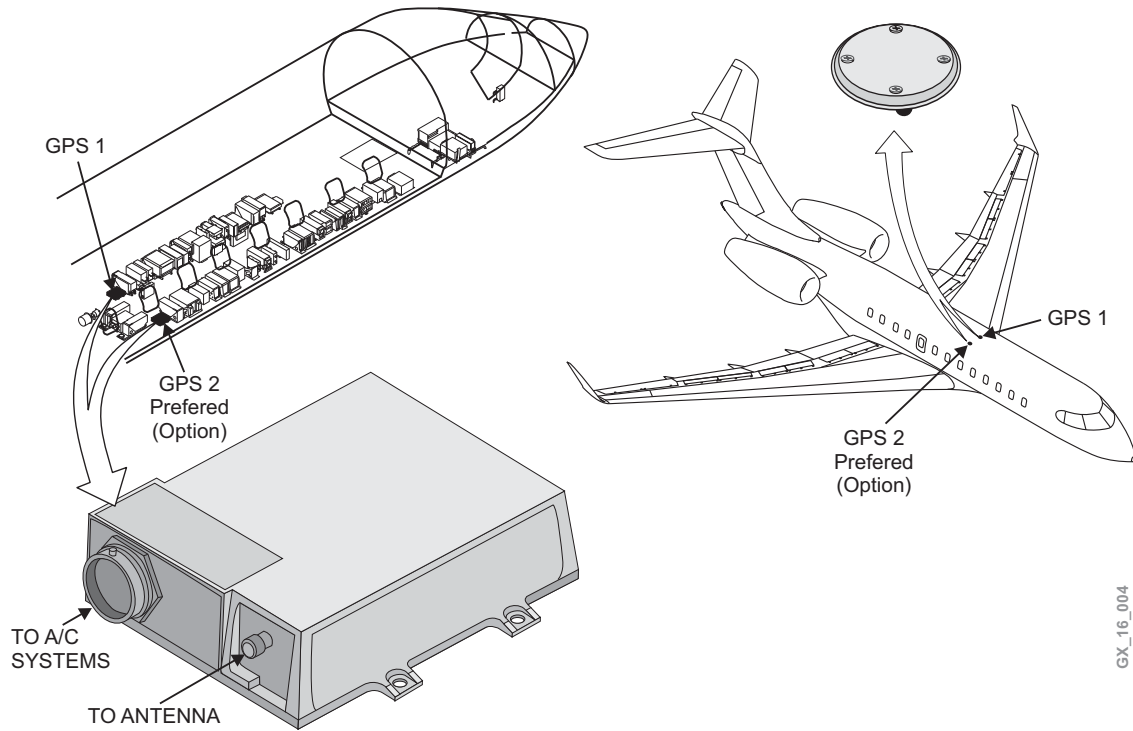

GX\_16\_004

The GNSSU has a Receiver Autonomous Integrity Monitor (RAIM) function. The RAIM monitors the status of the satellites that are used for calculations. The output of the RAIM function is an estimate of GPS position error. The RAIM value is sent to the FMS and the FMS uses this data to determine if it can use the GPS for navigation.

## MODES OF OPERATION

The GNSSU has seven operational modes:

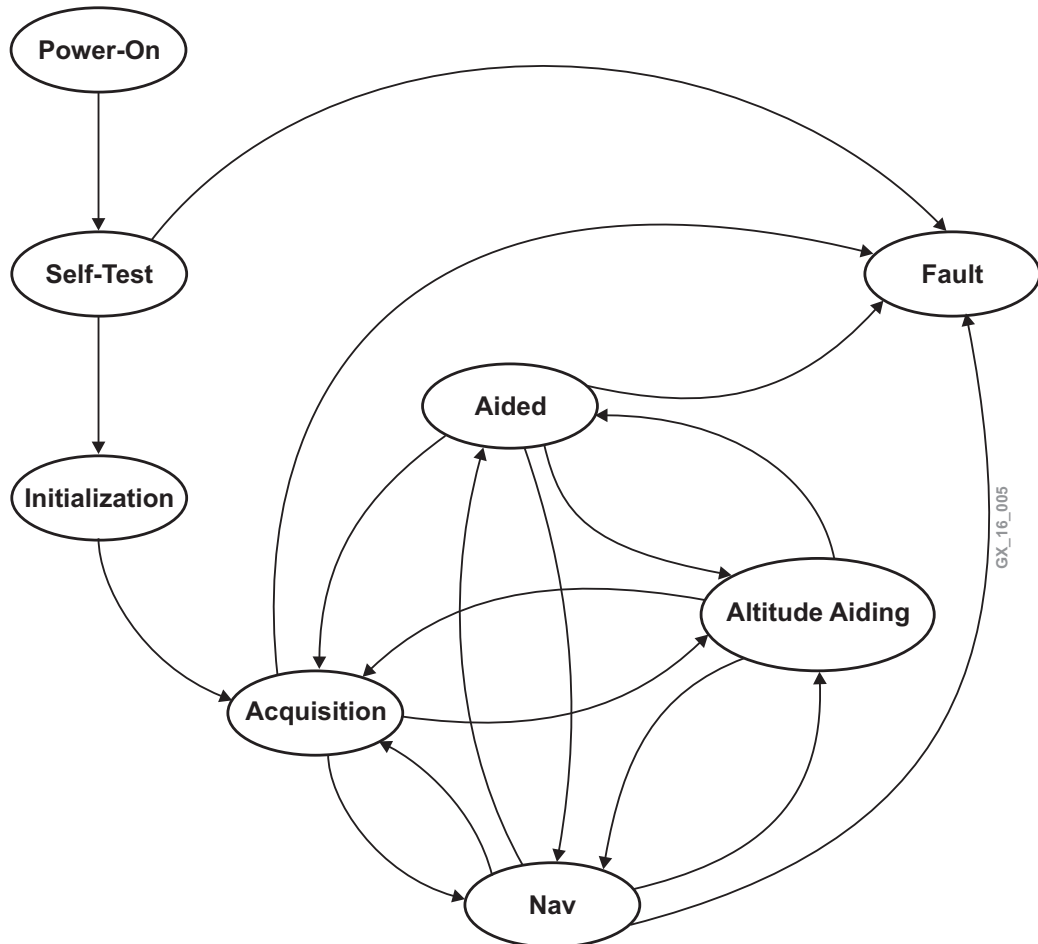

- Self-Test Mode – The GNSSU is in the self-test mode for approximately 5 seconds. When the self-test mode is complete, the GNSSU enters the initialization mode
- Initialization Mode – The FMS provides the GNSSU with initial position. It is in this mode for only a fraction of a second. When the hardware is initialized, the GNSSU enters the acquisition mode
- Acquisition Mode – The GNSSU enters the acquisition mode to acquire satellites (minimum 4), or from other modes (NAV or Aided), when it does not have sufficient satellite and/or aiding data to remain in either the NAV mode or the Aided mode. With initialization and almanac data available, the time to first fix (TTFF) of a satellite is less than 75 seconds. Without valid initial data, the GNSSU performs a search-the-skies acquisition and the TTFF of a satellite is less than 10 minutes. From the acquisition mode, the GNSSU enters the NAV mode

## Bombardier Global Express - Navigation

- Navigation (NAV) Mode – The GNSSU enters the NAV mode when it has computed a navigation solution that provides position, velocity, and time measurements. The GNSSU has acquired at least four satellites. The GNSSU sends GPS position data to the FMS. From the NAV mode the GNSSU enters the acquisition mode or aided mode
- Aided Mode – The GNSSU enters the aided mode when there is insufficient satellite and/or altitude information, but external-aided data (inertial velocities from the FMS) is available to continue to update the NAV filter. While in this mode, the GNSSU provides valid time outputs. From this mode, the GNSSU enters the NAV or acquisition mode. It will stay in this mode for a maximum of 5 minutes
- Altitude Aiding Mode – The GNSSU enters the altitude aiding mode if satellite measurements (less than 4) are not sufficient to maintain integrity or remain in the NAV mode, yet are sufficient when altitude information is available. This mode uses altitude data from the ADC to aid the navigation solution and integrity monitoring during extended periods of insufficient satellite coverage and geometry. When the calibrated pressure altitude deviation estimate is out of limits, it reverts to the aided mode. From this mode, the GNSSU enters the NAV or aided modes
- Fault Mode – The GNSSU enters the fault mode when any faults in the GNSSU is detected. This mode supersedes all other modes. Any fault will be reported on the FMS CDU. The FMS MSG indicator will illuminate and GPS 1 (2) FAILED message will appear in the FMS scratchpad

**GPS 1 FAILED**



## GPS Access

To access the GPS on the FMS CDU, proceed as follows:

Press NAV function key

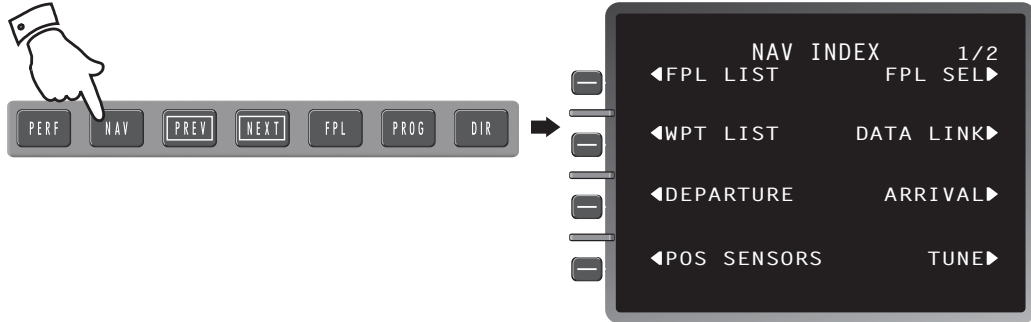

Press POS SENSORS key

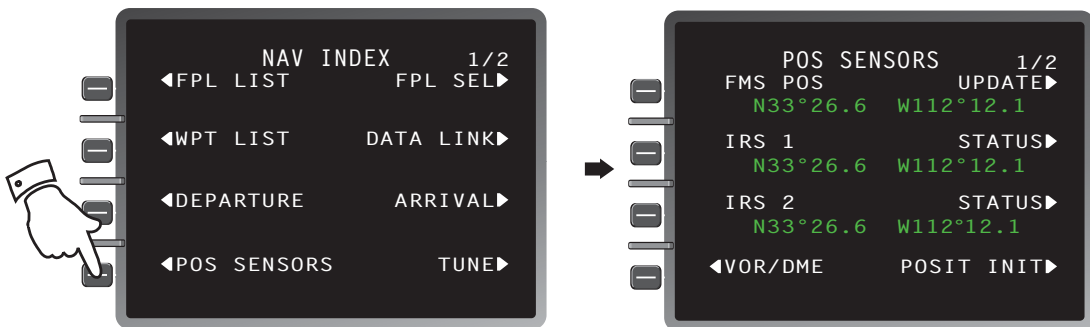

Press NEXT function key

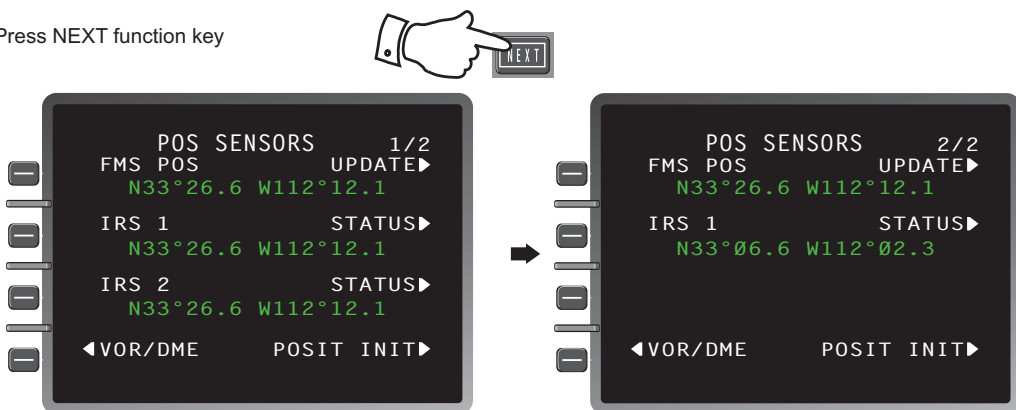

GX\_16\_006

## GPS Status

To view the GPS STATUS 1/2 on the FMS CDU, proceed as follows:

Press status KEY

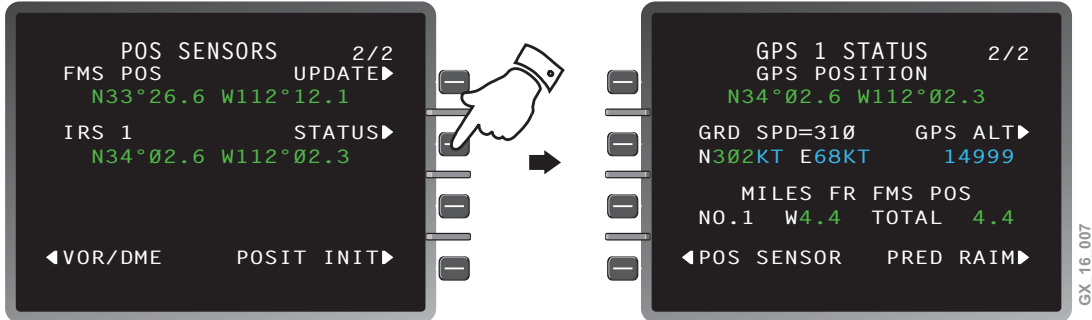

To view the GPS STATUS 2/2 on the FMS CDU, proceed as follows:

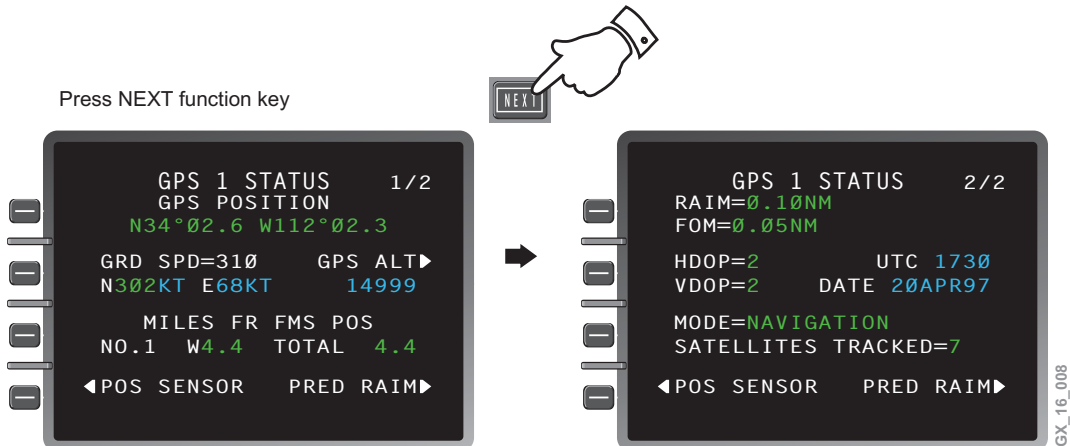

GPS STATUS 1/2 displays the following information:

- GPS position
- Groundspeed
- Altitude
- Miles from FMS position

GPS STATUS 2/2 displays the following information:

- Receiver Autonomous Integrity Monitor (RAIM)
- Figure of Merit (FOM)
- Horizontal Dilution of Precision (HDOP)
- Vertical Dilution of Precision (VDOP)
- Time (UTC) and Data
- Operating Mode
- Satellites Tracked

# Bombardier Global Express - Navigation

RAIM and FOM indicate current uncertainty of position expressed in nautical miles. HDOP and VDOP are numbers that rate current satellite geometry in the horizontal and vertical axis with 1 being the best geometry. Normally HDOP and VDOP numbers are below 10.

## NOTE

For more information refer to the Flight Management System Pilot's Guide.

## GPS SCHEMATIC

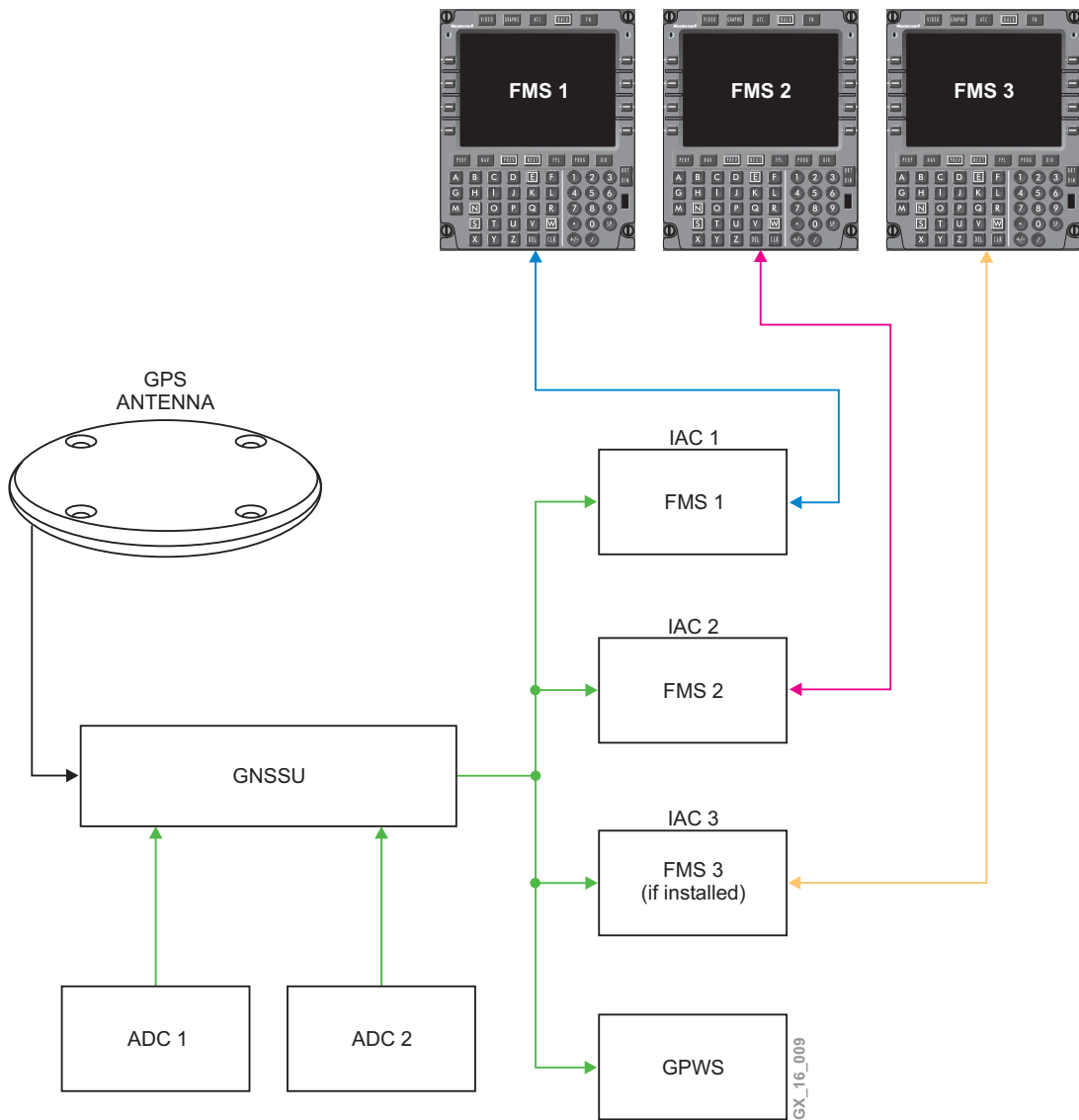

**NAVIGATION DISPLAY UNIT (IF INSTALLED)**

The Navigation Display Unit (NDU), also referred to as Lasertrack (LTRK), located on the pilot's side panel, is a combined navigation computer and display unit, that is used to initialize up to three inertial reference units (IRU) and to display navigation data based on a nine-waypoint flight plan and IRS inputs.

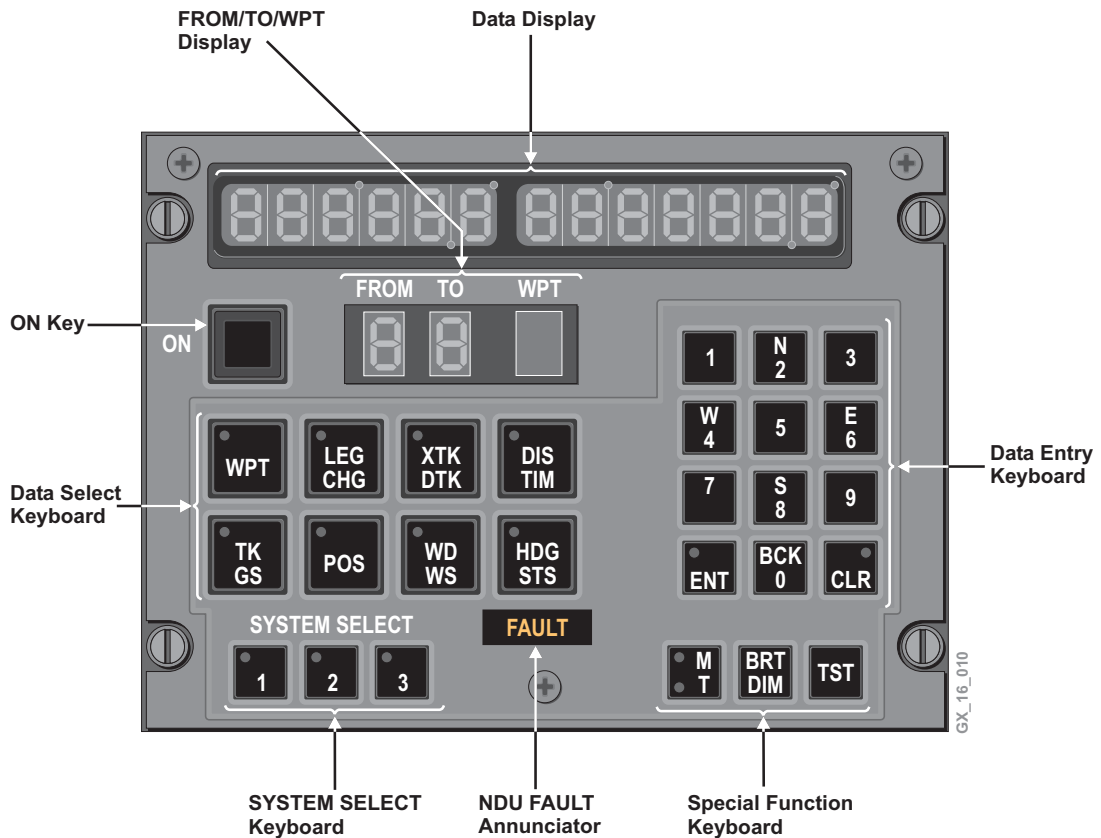

The following describes the controls of the NDU:

**ON KEY**

The ON Key is used to power on and power off the NDU.

## DATA ENTRY KEYBOARD

The data entry keyboard is used to enter, display, modify, or transmit initialization, leg change, and flight plan data. The data entry keyboard consists of the following:

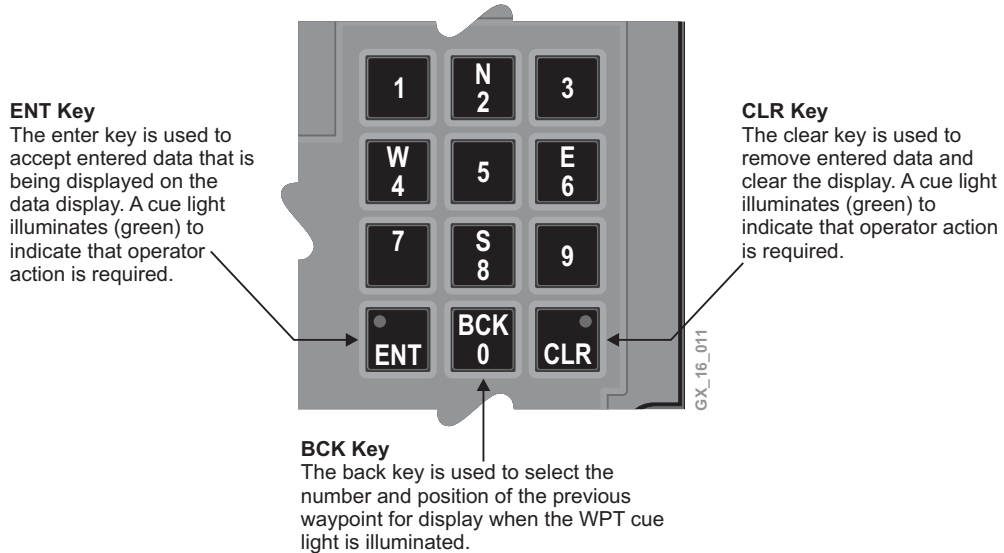

## SPECIAL FUNCTION KEYBOARD

The special function keyboard consists of the following:

### SYSTEM SELECT KEYS

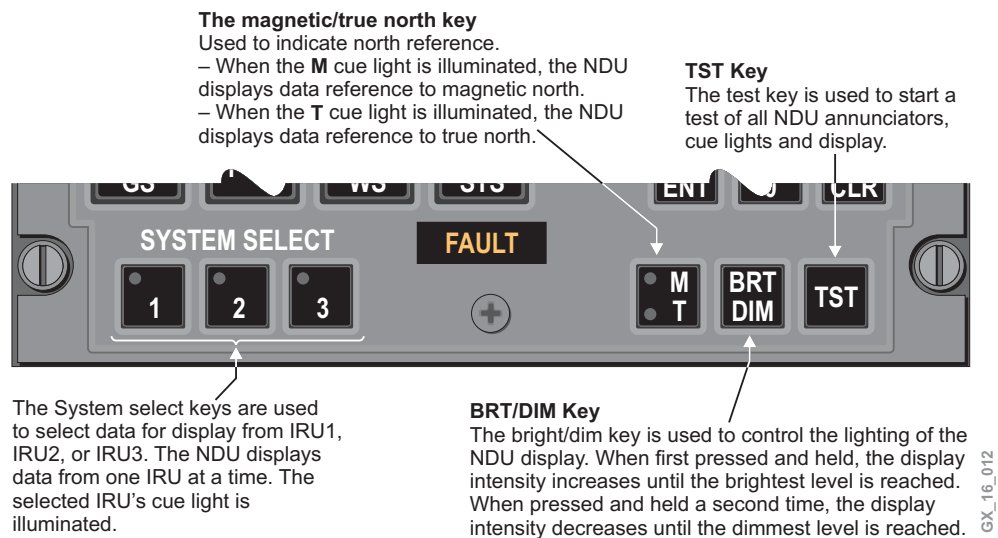

## DATA SELECT KEYBOARD

The data select keyboard is used to select data for display. Each key contains a cue light that indicates what type of data has been selected. When the WPT, LEG CHG, POS, or HDG STS key is pressed, the operator can enter new data or modify the data that the NDU is displaying. The data select keyboard consists of the following:

### LEG CHG Key

The leg change key is used to define or modify the current flight plan leg by displaying the FROM and TO waypoint numbers. The current leg must be defined before navigation data can be defined and displayed.

### XTK DTK Key

The crosstrack/desired track key is used to select and display the cross track error in nautical miles from the current leg and the desired track of that leg.

### DIS TIM Key

The distance/time key is used to select and display the distance and time to the TO waypoint based upon present position and current groundspeed.

### WPT Key

The waypoint key is used to build and display a flight plan consisting of one to nine waypoints. When the key is repeatedly pressed, the NDU displays the successive flight plan waypoints by number and position.

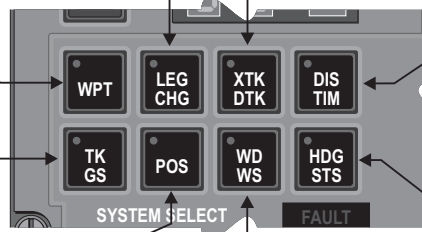

### HDG STS Key

The heading/status key is used to display the current airplane heading. When the IRU is in align mode, the NDU displays alignment status (time remaining until NAV mode entry). When the IRU is in NAV mode, the NDU displays in the left display. When the IRU is in altitude mode, the NDU displays magnetic heading in the left display and "ATT" in the right.

### TK GS Key

The track/groundspeed key is used to select and display the current track and groundspeed

### POS Key

The position key is used to initialize and display the present position of the airplane.

### WD STS Key

The wind direction/wind speed key is used to select and display the current wind direction and wind speed.

GX\_16\_013

## DISPLAYS

The NDU contains a data display and a FROM TO WPT display.

The NDU data display consists of two displays, a six-position and a seven-position display, each having degree, decimal and minute indicators.

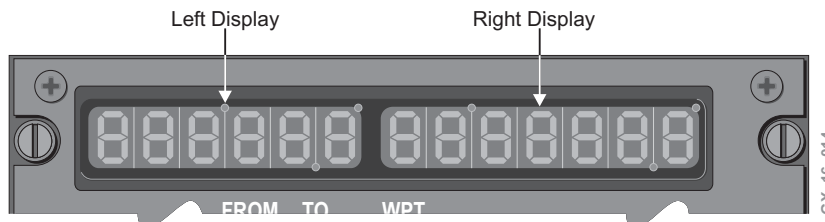

GX\_16\_014

## NDU UPDATE

To update the NDU (pre-flight), proceed as follows:

### Power On

- Power the NDU on

### Test

- Test the NDU displays, annunciators, and cue lights

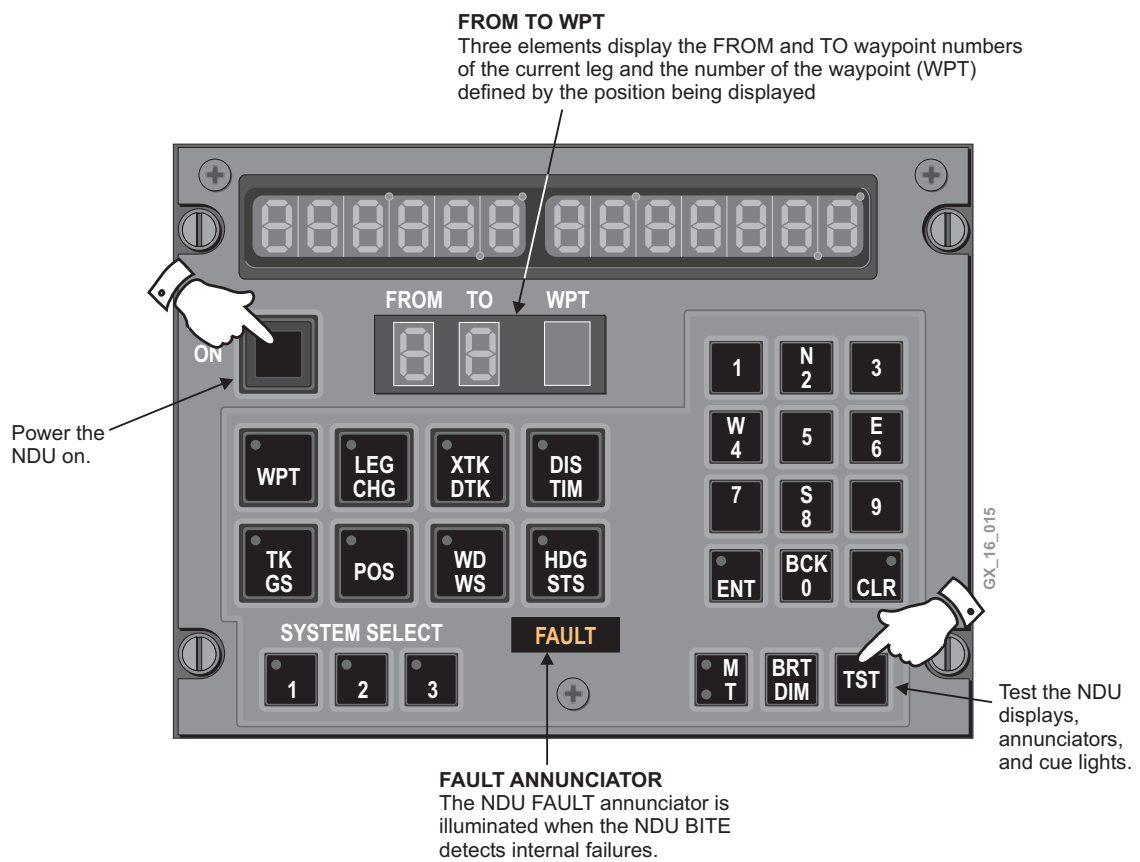

**POSITION ENTRY**

The following procedures can be used for position entry (initialization) during IRU alignment and align downmode.

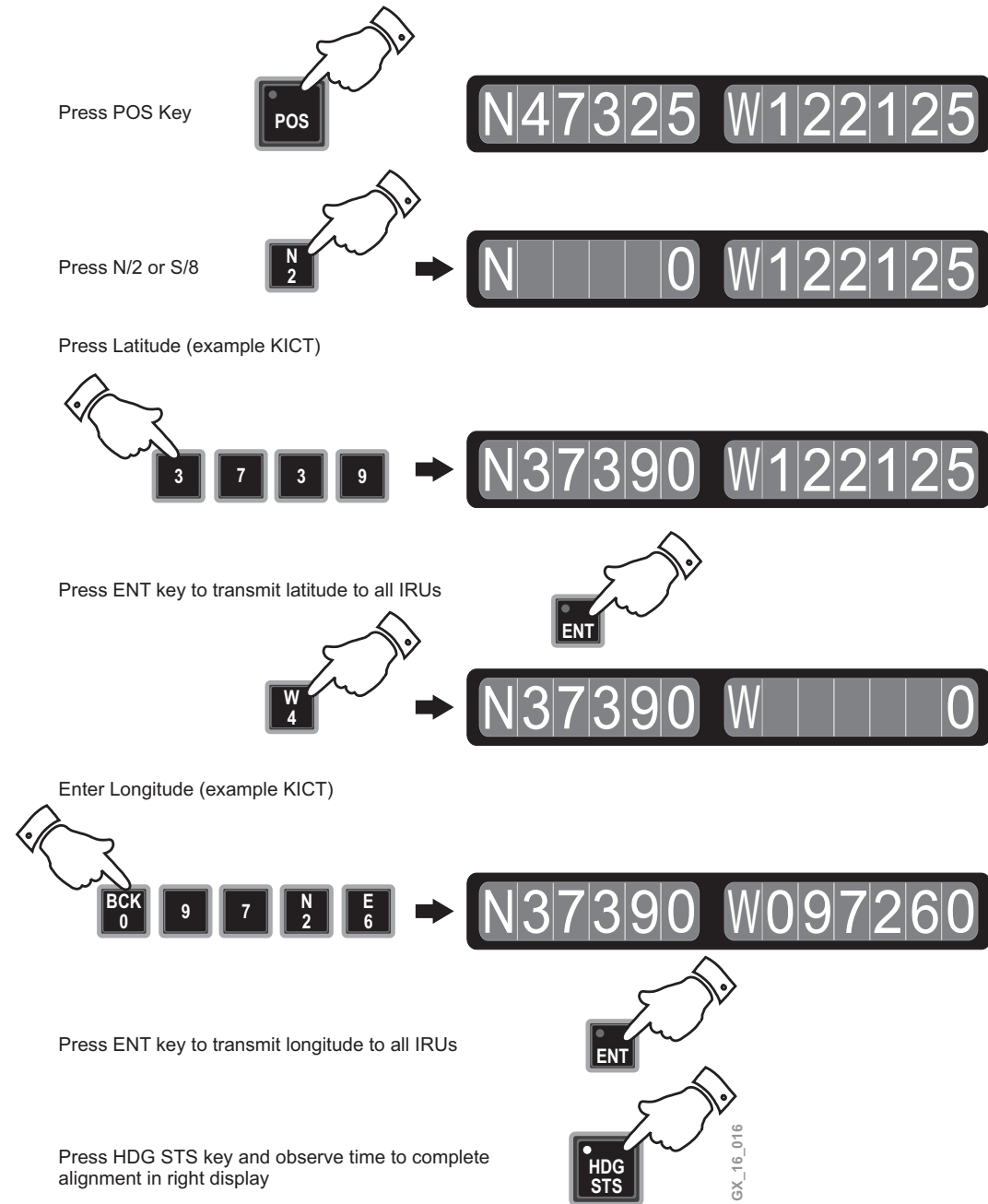



# Bombardier Global Express - Navigation

Enter the magnetic heading when the attitude mode has been selected.

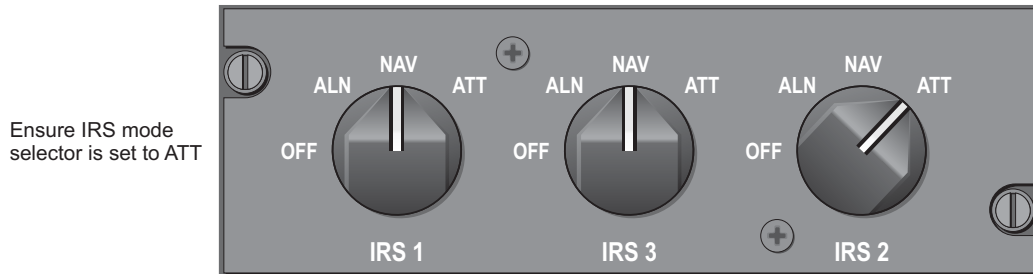

Press appropriate SYSTEM SELECT key

SYSTEM SELECT

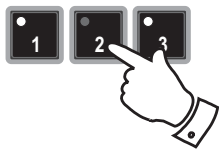

N47325 W122125

Press HDG STS



- - - W Att

Press Latitude (example KICT)

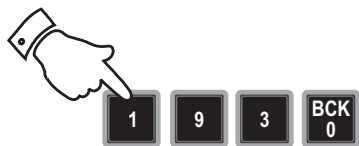

N 1930 Att

Press ENT key to transmit heading to all IRUs



GX\_16\_017

## NOTE

For more information, refer to the LASERTRACK Navigation Display Unit of the Pilot's Manual.

NDU SCHEMATIC

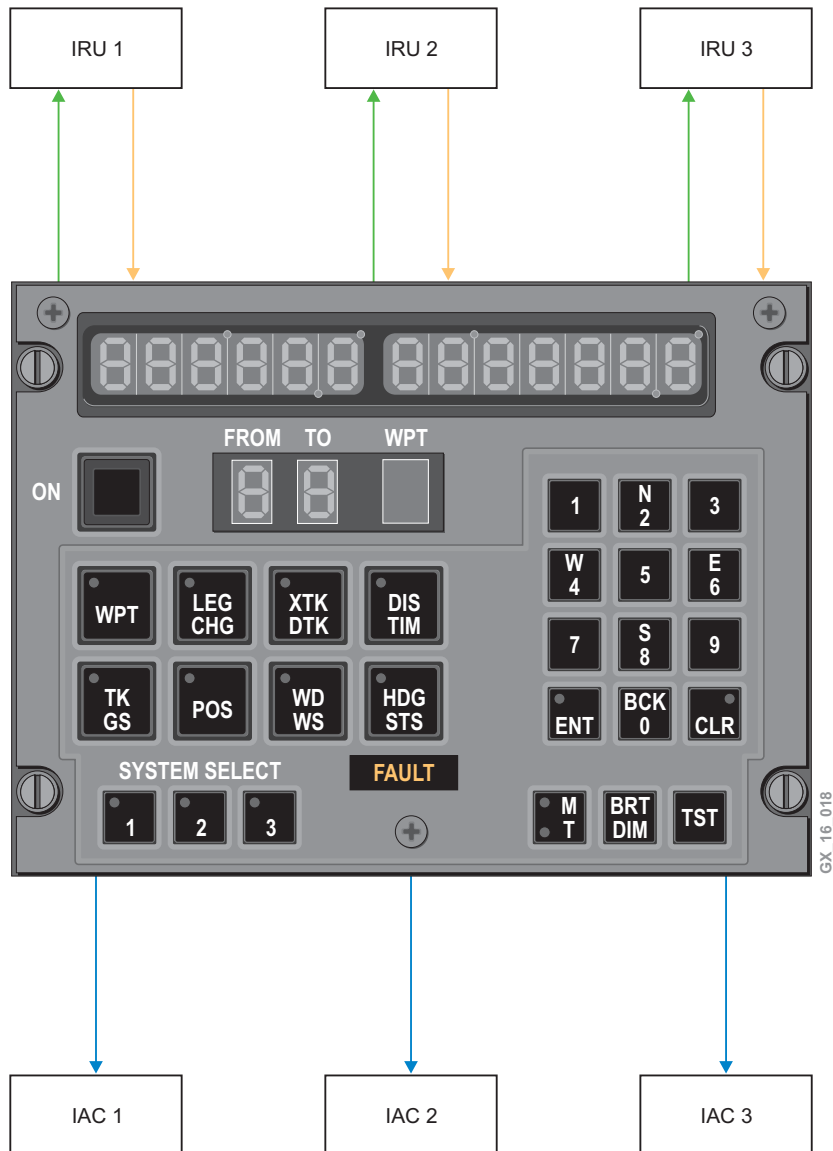

### **INERTIAL REFERENCE SYSTEM**

The inertial sensors consist of three ring laser gyros and three accelerometers. The accelerometers measure linear motion along the longitudinal, lateral and vertical axis. The ring laser gyros measure angular motion about the longitudinal, lateral and vertical axis.

The Inertial Reference System (IRS) provides attitude, directional, position and 3-axis rate/accelerometer data to the following airplane systems:

- PFDs and MFDs
- Weather radar system
- AFCS
- EGPWS
- TCAS
- Stall protection system
- Fuel system
- Flight data recorder
- Air data computer
- FMS

Each IRS computer (IRS 1, IRS 2, IRS 3) receives true airspeed and altitude from the applicable air data system. In the event of a failure of the air data input, the backup input should be manually selected using the reversion control panel.

The IRS mode select panel, located on the pedestal, is used to initialize the IRS and to select NAV or ATT modes.

# Bombardier Global Express - Navigation

## IRS Mode Switches

**OFF** – Removes power from IRS. Power down mode, IRS will turn off in approximately 10 seconds.

**ALN** – Aligns IRS in approximately 7 minutes (time to align will differ with temperature and latitude)

**NAV** – Normal operating mode, selected after ALN completed

**ATT** – Reversionary mode, used to provide attitude information, in the event of NAV mode failure

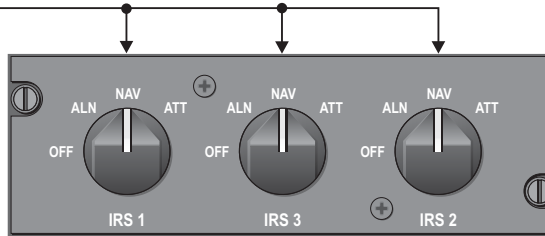

**NOTE:** During IRS initialization the PFD is in a failure mode.

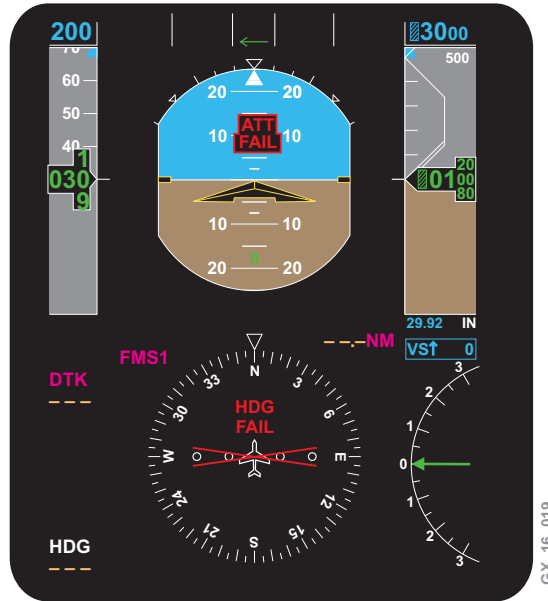

At an IRS internal temperature between - 54°C and - 40°C, the power supply will turn on, but normal alignment will not start until IRS temperature is >- 40°C. The IRS will not go to NAV mode until the internal temperature of IRS reaches - 15°C.

| LOW TEMPERATURE ALIGNMENT     |                                   |
|-------------------------------|-----------------------------------|
| IRS INTERNAL TEMPERATURE (°C) | TIME TO COMPLETE ALIGNMENT (MIN.) |
| <-12.5                        | 16                                |
| -12.5 to -10.0                | 15                                |
| -10.0 to -7.5                 | 14                                |
| -7.5 to -5.0                  | 13                                |
| -5.0 to -2.5                  | 12                                |
| -2.5 to 0                     | 11                                |
| > 0                           | 7                                 |

Inertial reference accuracies are achieved for alignments between  $\pm 78.25^\circ$  of latitude.

The IRS requires that the initial position be entered from either flight management system (FMS) control display unit (CDU) via the POS INIT page.

**NOTE**

Aircraft must be stationary during the alignment. If the aircraft is moved, the mode select switch must be set to OFF for a minimum of three seconds before the align mode can be reestablished.

Align downmode is possible, once the IRS is in navigation mode, by selecting the NAV/ATT switch from NAV to ALN for a minimum of three seconds until ATT FAIL appears and back to NAV. Velocity errors are corrected and tilt errors are removed to correct the pitch and roll angles. The total rapid realignment time is 30 seconds. Present position is optional to be reentered.

The reversion control panel, located on the pedestal, is used for pilot reversion of the IRS.

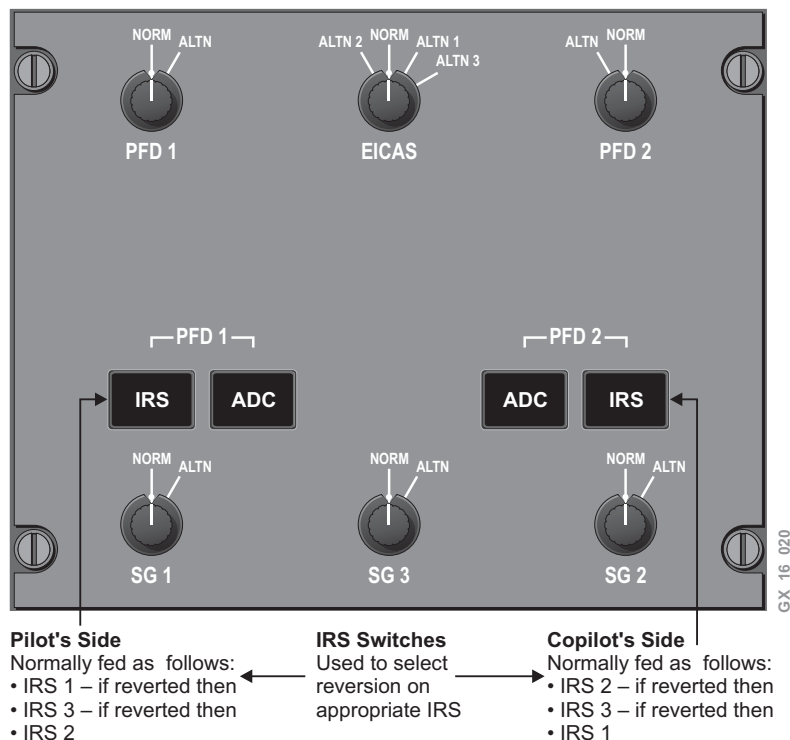

The reversionary attitude mode, which provides attitude, heading, rate and acceleration data, but not position data, may be selected when navigation mode is not available. This condition may occur in the air, following a power interrupt or transient system fault. Attitude alignment takes 1 minute from power off to ATT mode or 34 seconds from NAV to ATT mode, provided the airplane is stationary on the ground or in straight and level flight. If excessive motion is detected, the attitude alignment is run for an additional 20 seconds. Once attitude alignment is complete, heading is entered from the FMS. Heading entries may be made, while the IRS is in the attitude mode, to correct for heading drift.

**CAUTION**

**During flight, navigation reference is lost if the MSU mode select switch is set away from NAV.**

**NOTE**

IRS will not restart or realign on airplane battery bus power. If airplane primary power is lost, IRS can continue to operate on airplane direct battery bus power.

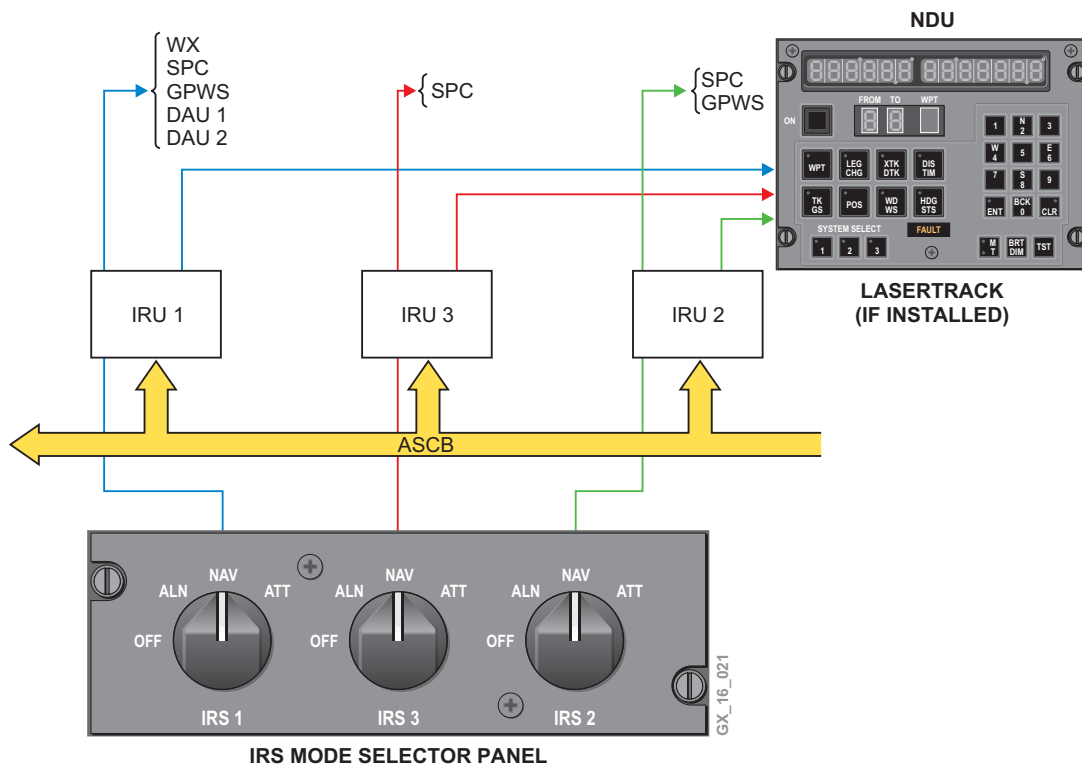

### **LASEREF IV DIFFERENCES**

The differences between Global aircraft installed with the LASEREF IV and the aircraft installed with LASEREF III are as follows:

- 9 pounds lighter
- Mean Time Between Failures (MTBF) 17,000 flight hours versus 7000 for LASEREF III
- Consumes less power
- Auto NAV Realign function anytime the aircraft is not moving. Zeroes out velocity errors
- Updated MAG MAPS

## WEATHER RADAR (WX)

The weather radar control panel, located on the pedestal, controls GAIN, RADAR modes, TILT and Lightning Sensor System (LSS) (if installed). It also enables turbulence (TRB) mode, antenna stabilization (STAB), target alert (TGT) and sector scan (SECT).

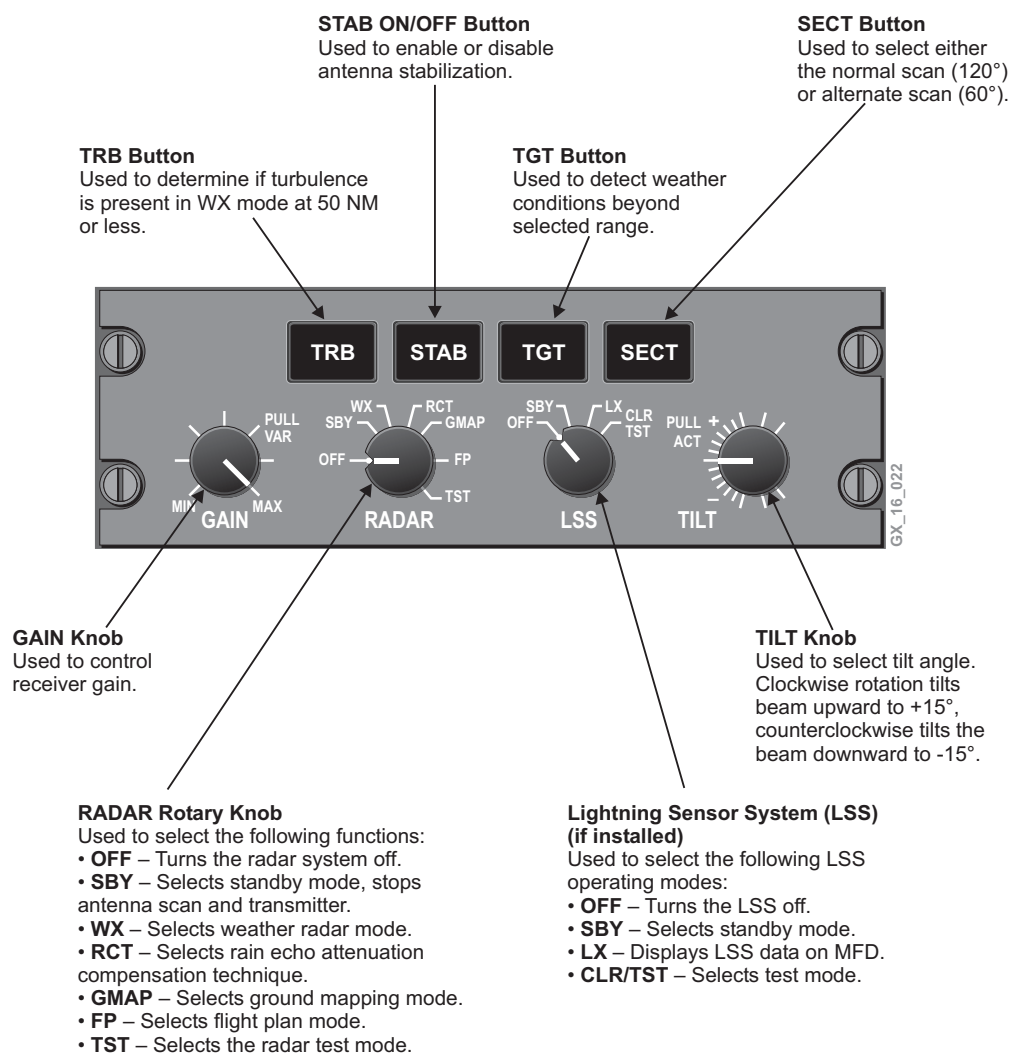



The weather radar system provides a display of X-band radar detectable areas of precipitation along and within 60° on either side of the airplane's flightpath. Weather radar returns, turbulence and lightning (if LSS installed) are displayed on the MFDs (MAP mode only). A range of up to 300 NM from the airplane is selectable using the up or down buttons on the MFD control panel.

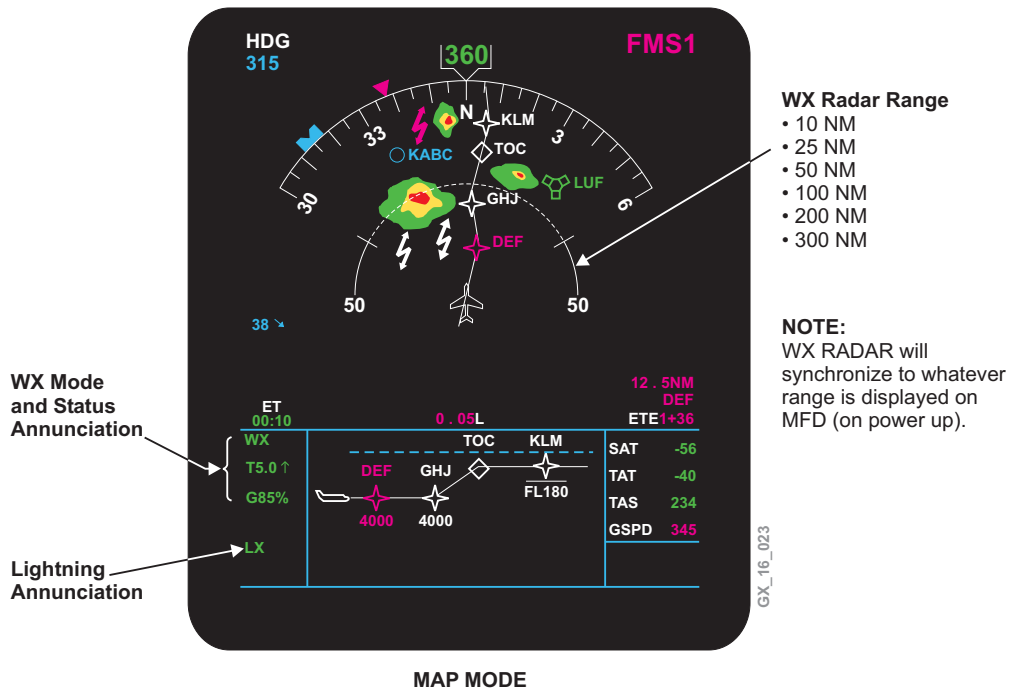

## RADAR ANTENNA

The antenna sweep is selectable for either 120° (60° each side of the airplane) or 60° (30° each side). The antenna tilt is adjustable between - 15° (down) and + 15° (up). The antenna maintains its stabilization with respect to the horizon regardless of the airplane attitude (within - 15 to + 15°).

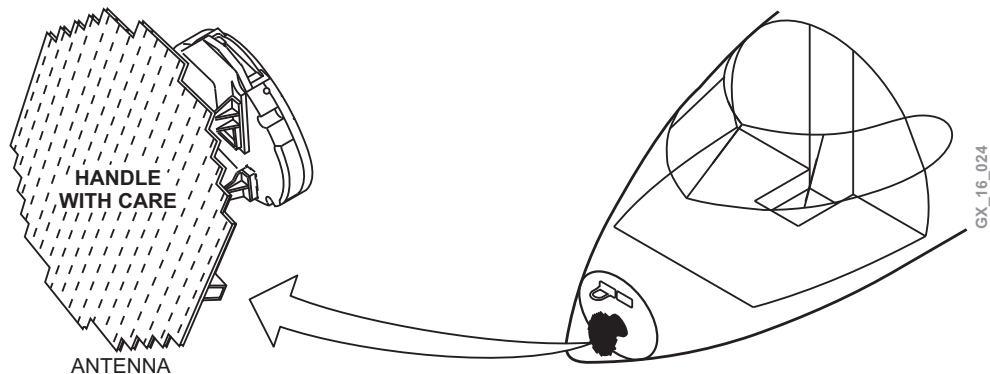

## MODE SELECTION

The weather radar operating modes, gain and antenna tilt functions are all controlled by the two radar control panels. Both the pilot and copilot can look at different ranges and tilt settings at the same time on their respective MFDs.

The weather radar modes and features are as follows:

- **TRB.** Momentarily pressing the TRB button enables the turbulence mode. When this mode is selected, the radar determines if turbulence is present. TRB can only be engaged in the WX mode and in selected ranges of 50 NM or less. The weather/turbulence WX/T mode is annunciated in the status display. Areas of at least moderate turbulence are shown in soft white.

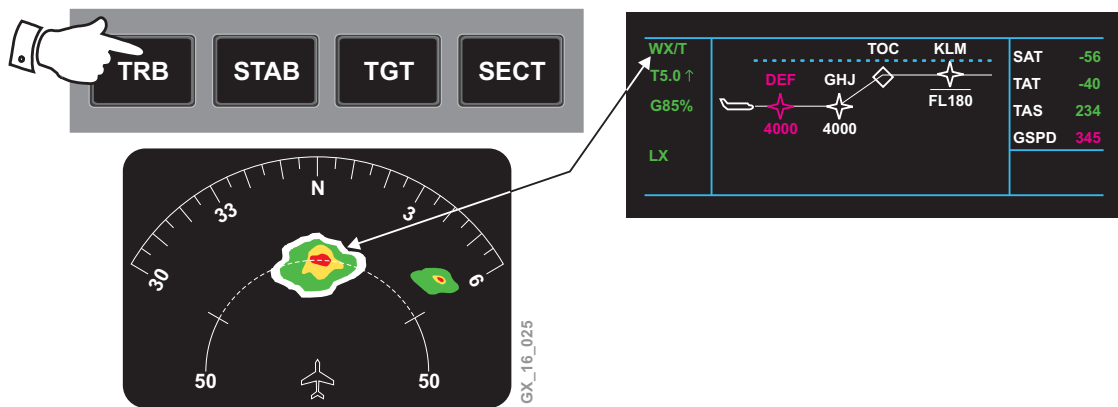



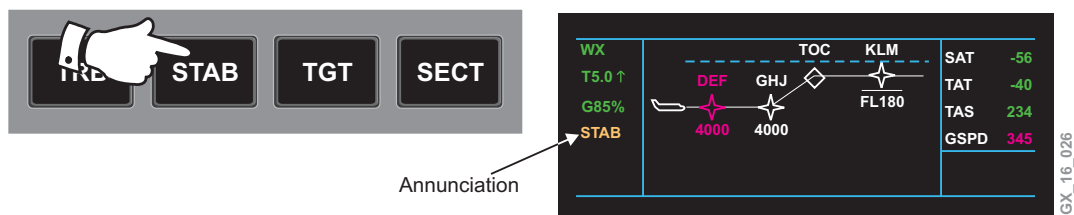

- **STAB.** The STAB button turns the pitch and roll stability ON and OFF. The stabilization system uses IRS as a reference. It is also used to override forced standby and get radar display on the ground (press 4 times in 3 seconds). STAB is annunciated (in amber) in the status display.



- **TGT.** Target alert monitors for red or magenta weather conditions (rainfall rate) beyond the selected range, 7.5° on each side of the airplane heading, and is selectable in all but the 300 NM range. If such weather is detected outside the selected range, the TGT alert annunciation changes from green armed to an amber alert condition on the MFD WX Status display. When this warning is received, the pilot should select longer ranges to view target alert. When TGT button is selected, TGT annunciation will replace the GAIN annunciation in the status display.

# Bombardier Global Express - Navigation

| Rainfall Rate |          | Color   |
|---------------|----------|---|
| in/hr         | mm/hr    |   |
| .04 to .16    | 1 to 4   |  |
| .16 to .47    | 4 to 12  |  |
| .47 to 2.0    | 12 to 50 |  |
| >2            | >50      |  |

### RAINFALL COLOR CODING

TGT will be displayed as TGT (flashing), if red or magenta is detected outside selected range.

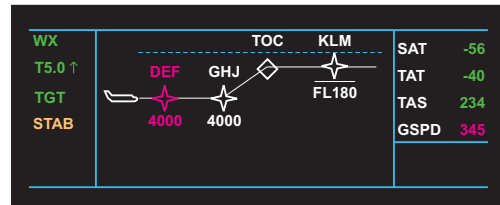

GX\_16\_027

- **SECT.** The normal radar sweep is  $\pm 60^\circ$  from the airplane nose at a rate of 12 sweeps/min. Pressing SECT button reduces the angle of sweep to  $\pm 30^\circ$  at a rate of 24 sweeps/min. Pressing the SECT button again returns to normal sweep. Both the pilot's and copilot's displays will show the same sweep angle.

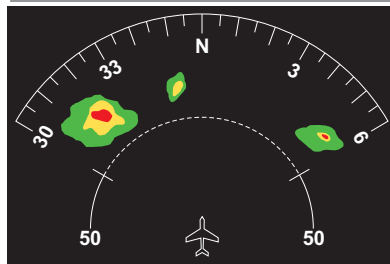

120° ARC

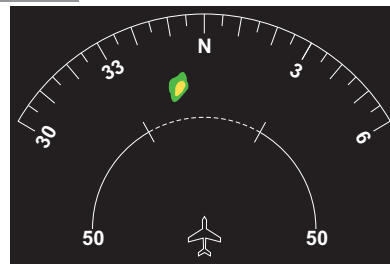

60° ARC

GX\_16\_028

- **GAIN.** The GAIN knob is a rotary control and push/pull switch that is used to control the receiver gain. Push on the GAIN switch to enable the preset calibrated gain mode. Calibrated gain is the normal mode and is used for weather avoidance. Pull out on the GAIN switch to enable the variable gain mode. Variable gain is used to provide additional weather analysis and for ground mapping. In WX mode, variable gain receiver sensitivity can be increased to show weak targets or can be reduced to eliminate weak returns.

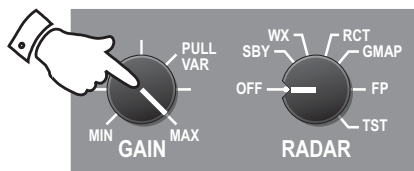

**Annunciation**  
Displayed only when switch is pulled out (variable gain)

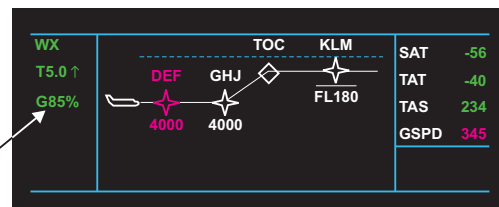

GX\_16\_029

## WX SYSTEM OPERATION

The RADAR rotary knob is used to select the following functions:

- **OFF**. Turns the radar off. The system is no longer radiating and the antenna is stowed.

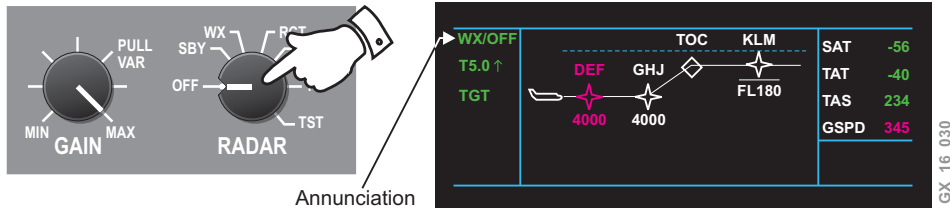

- **SBY**. Places the radar system in standby mode. It takes approximately 45 seconds for the system to warm up after being switched out of SBY.

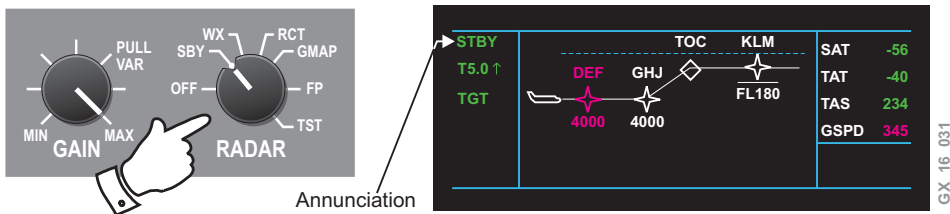

- **WX**. Selects the weather detection mode of operation. When WX is selected, airplane in-flight, the system is fully operational and all parameters are set for enroute weather detection. If the rotary knob is moved directly from OFF to WX, the system will first go into SBY for approximately 45 seconds, then become active. There is also a hidden mode, Forced Standby FSBY. This mode is enabled automatically on the ground, if the airplane is powered up, with the radar selected to WX. To exit FSBY, push STAB button 4 times within 3 seconds. This mode prevents the radar from radiating, thereby protecting the ground personnel from radiation exposure.

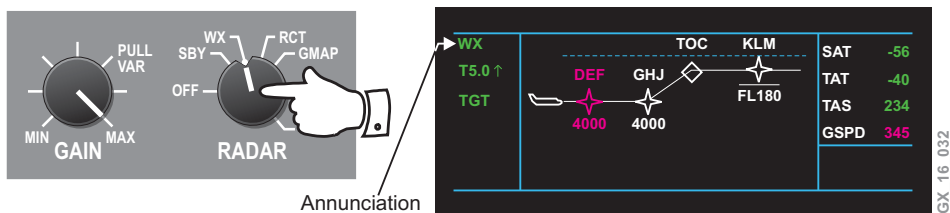

- **RCT**. Enables the Rain Echo Attenuation Compensation Technique (REACT). The REACT compensates for attenuation of the radar signal as it passes through rainfall. Strong targets (high attenuation levels) cause the receiver to reach its maximum gain value in a short time/short range. Weak targets (low attenuation levels) cause the receiver to reach its maximum gain in a longer time/longer range. When this maximum gain value is reached, a cyan background field will appear. Any target inside of the cyan area will appear in magenta color, indicating maximum severity.

# Bombardier Global Express - Navigation

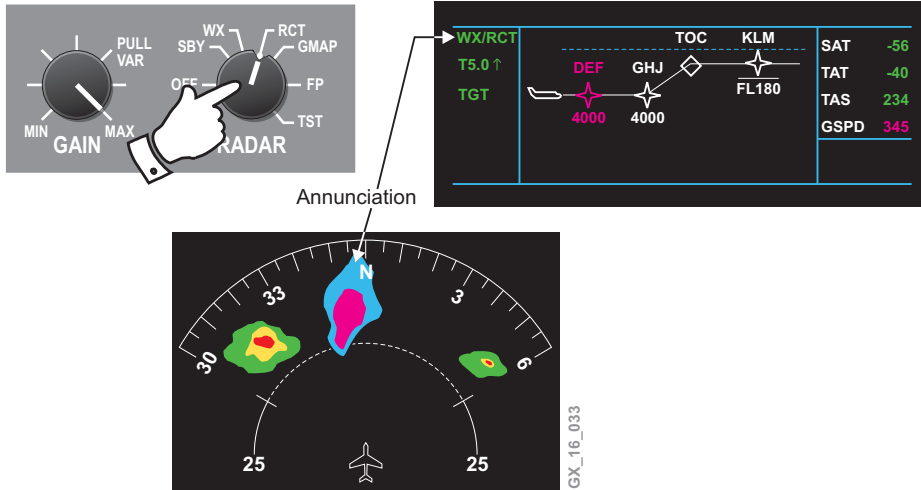

- **GMAP**. Selects the ground mapping mode. The auto TILT control is turned down until the amount of terrain is displayed. The color scheme is changed to cyan (least reflective return), yellow (moderate return) and magenta (strong return).

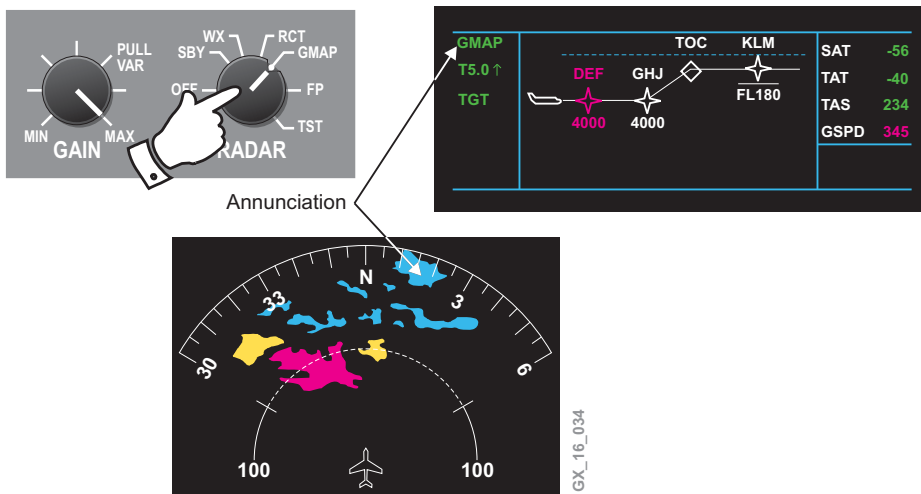

- **FP**. Selects the flight plan mode. This clears the screen of radar data so ancillary data can be displayed, such as navigation displays and lightning data. In the FP mode the radar RTA is put to standby and the FPLN legend is displayed in the mode field.

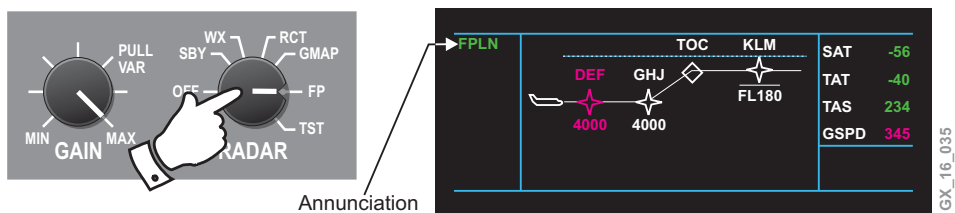

## Bombardier Global Express - Navigation

- **TST**. Selects the test mode. The test position selects a special test pattern, to verify system operation. When the TEST is complete, the radar enters the FSBY mode.

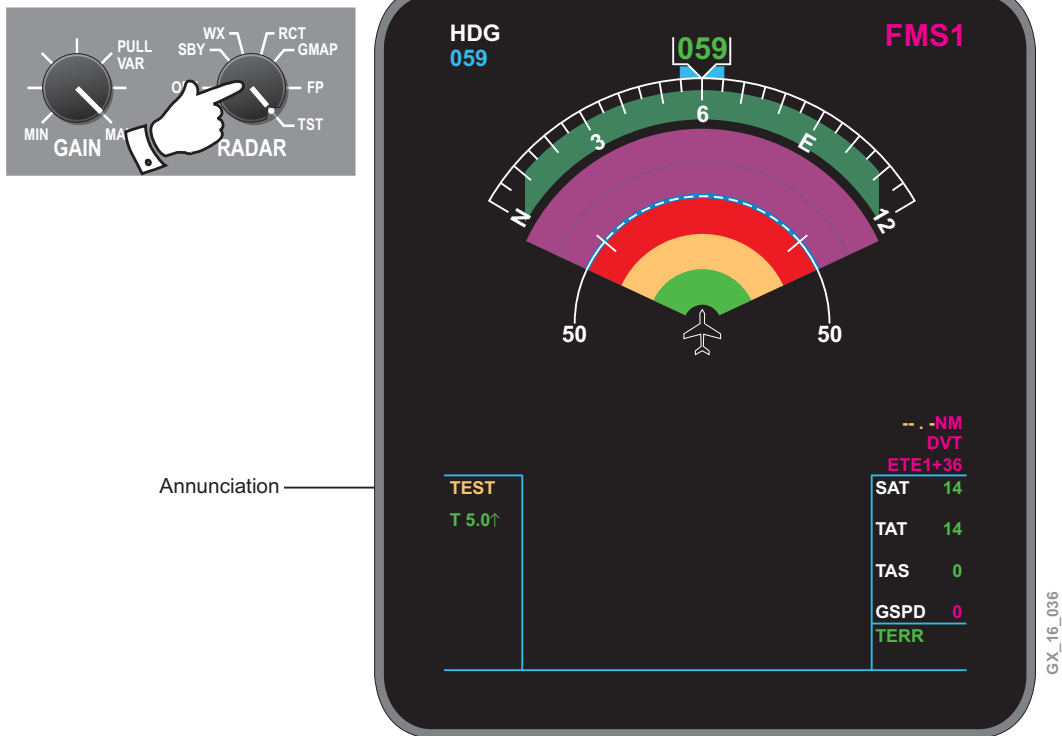

### NOTE

Operating techniques to improve radar life:

1. The best way for an operator to improve radar life is to use it only when it is needed. For example, it is not needed:
  - During flights in VFR conditions.
  - On a long flight, if the radar is needed for departure and no enroute weather is expected, turn the radar off in cruise. It can be turned back on if needed.

A good philosophy for radar operation during VFR conditions is to operate the radar for half an hour or an hour at the start of each flight day, and then turn it off for the rest of the day. This

will give the crew confidence that the radar is working and will drive off any condensation.

2. There is no cause for concern that the radar may be harmed if it has become cold-soaked at altitude during a flight and then is turned on if needed, or that it will not turn on after a cold soak. There is also no reason to worry that, if the radar is not on during landing, the elevation drive mechanism could be damaged by the slight 'bump' at touchdown.
3. For 10 kilowatt magnetrons, extended operation (several hours at a time) in standby may actually be worse than transmitting.
4. Despite point 3, ramp operations shall be limited to STBY.

### **TILT**

The TILT rotary knob is used to manually select the tilt angle of the antenna. Clockwise rotation of knob tilts the antenna upward to + 15° and counterclockwise rotation of knob tilts antenna downward to - 15°. When the TILT knob is pulled out to the Altitude Compensated Tilt position (Pull ACT), the antenna tilt is automatically adjusted with regard to selected range and barometric altitude. The tilt control can fine tune the tilt setting by  $\pm 2^\circ$ . When in ACT, an A symbol will appear following the digital tilt readout.

### **TILT MANAGEMENT**

The pilot can use tilt management techniques to minimize ground clutter when viewing weather targets.

Assume the aircraft is flying over relatively smooth terrain that is equivalent to sea level in altitude. The pilot must make adjustments for the effects of mountainous terrain.

# Bombardier Global Express - Navigation

The following figure helps to visualize the relationship between tilt angle, flight altitude, and selected range. It shows:

- Distance above and below aircraft altitude that is illuminated by the flat-plate radiator during level flight with 0° tilt
- Representative low altitude situation, with the antenna adjusted for 2.8° up-tilt

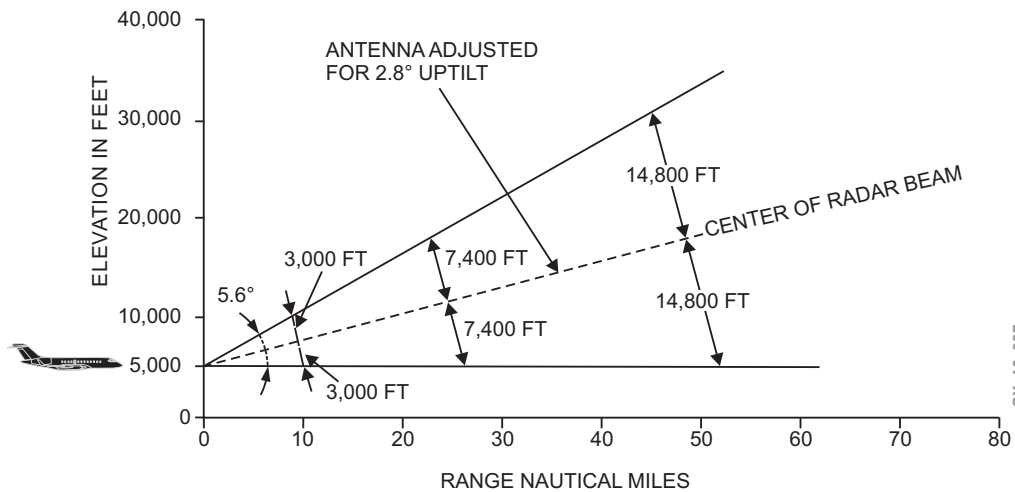
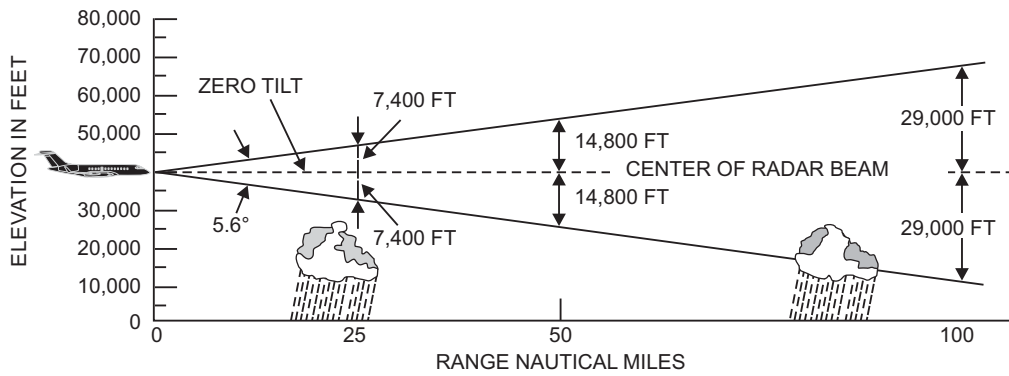
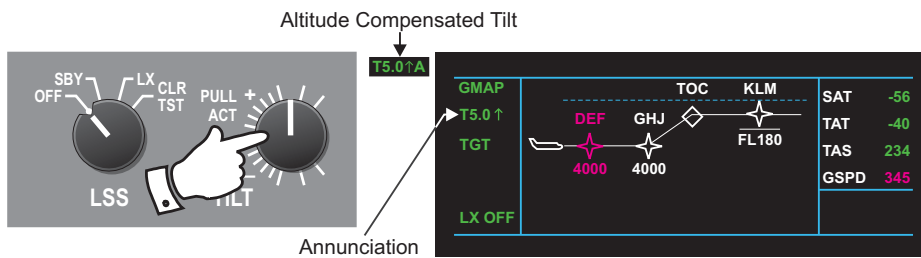

GX\_16\_037



## Bombardier Global Express - Navigation

The following figure gives the approximate tilt settings at which ground targets begin to be displayed on the image periphery for an 18-inch radiator. The range at which ground targets can be observed is affected by the curvature of the earth, the distance from the aircraft to the horizon, and altitude above the ground. As the tilt control is rotated downward, ground targets first appear on the display at less than maximum range.

To find the ideal tilt angle after the aircraft is airborne, adjust the TILT control so that groundclutter does not interfere with viewing of weather targets. Usually, this can be done by tilting the antenna downward in  $1^\circ$  increments until ground targets begin to appear at the display periphery. Ground returns can be distinguished from strong storm cells by watching for closer ground targets with each small downward increment of tilt. The more the downward tilt, the closer the ground targets that are displayed.

When ground targets are displayed, move the tilt angle upward in  $1^\circ$  increments until the ground targets begin to disappear. Proper tilt adjustment is a pilot judgment, but typically the best tilt angle lies where ground targets are barely visible or just off the radar image.

The figure gives the approximate tilt settings required for different altitudes and ranges. If the altitude changes or a different range is selected, adjust the tilt control as required to minimize ground returns.

# Bombardier Global Express - Navigation

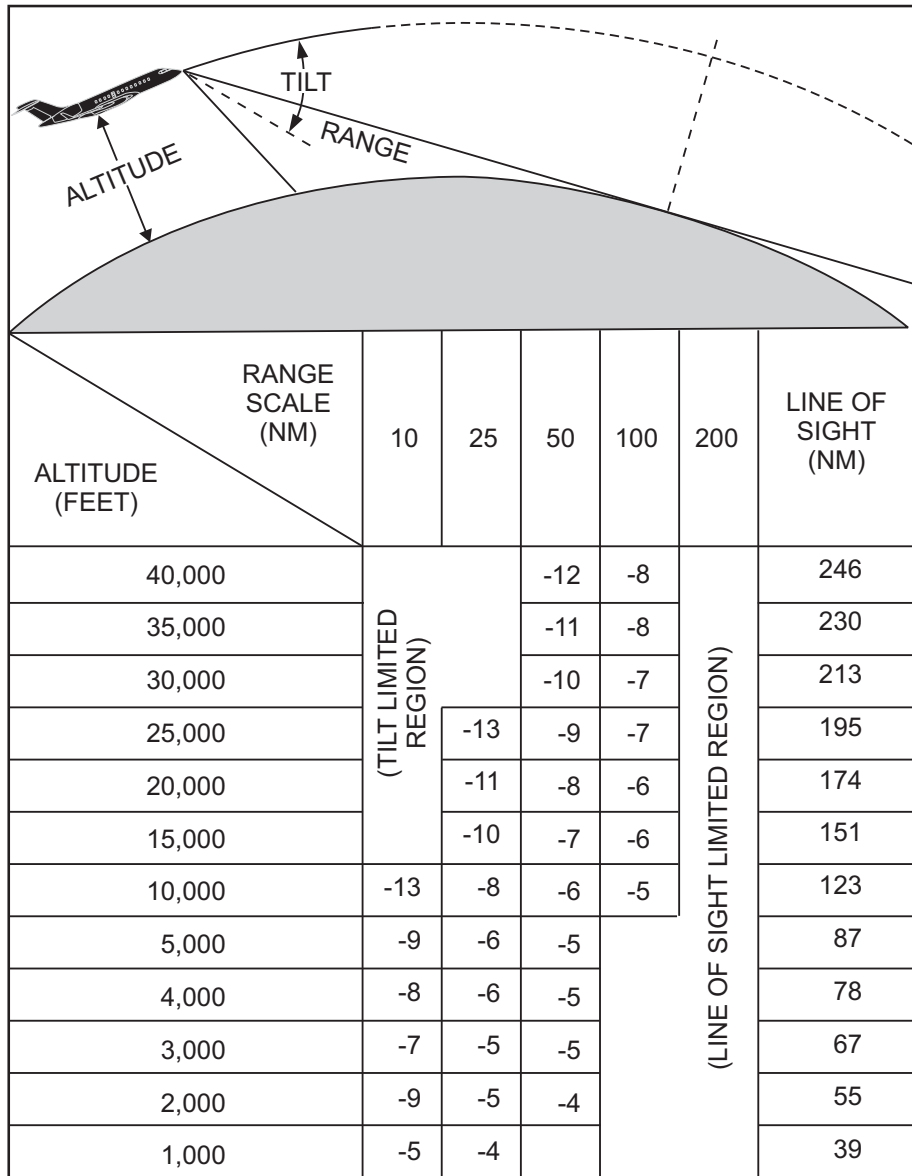

GX\_16\_042

Tilt angles shown are approximate. Where the tilt angle is not listed, the operator must exercise good judgment.

## NOTE

The line of sight distance is nominal. Atmospheric conditions and terrain affect this value.

**LIGHTNING SENSOR SYSTEM (LSS) (IF INSTALLED)**

The lightning sensor system is used to detect lightning. The LSS rotary knob is used to select the following functions:

- **OFF.** Turns off the LSS (if installed)

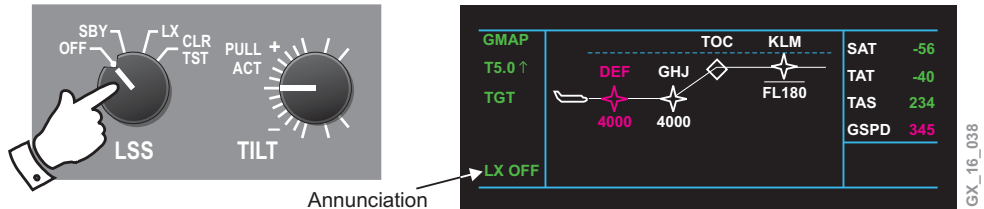

- **SBY.** Selects the LSS in standby mode. The data is inhibited, but LSS accumulates data.

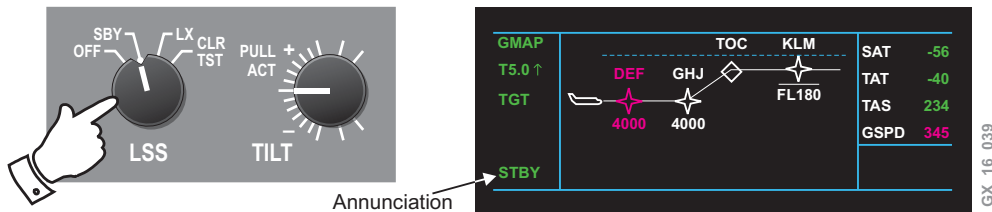

- **LX.** LSS is fully operational and displays data on the MFD. As it is a passive listening device, lightning display is available on ground.

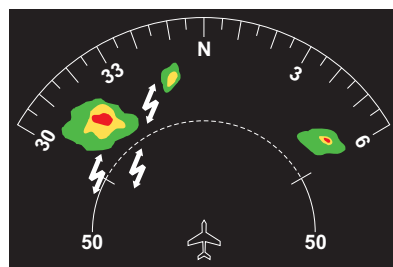
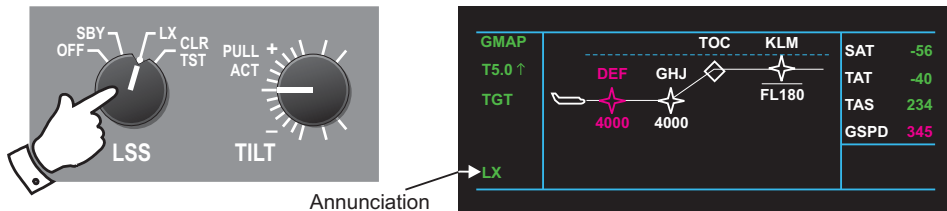

- Rate 1:** Lightning rate of 2-15 strokes in the last 2 minutes.
- Rate 2:** Lightning rate of 16-31 strokes in the last 2 minutes.
- Rate 3:** Lightning rate of >32 strokes in the last 2 minutes.
- ALERT:** Range is indeterminate but bearing accurately determined. Azimuth should be closely monitored.

- **CLR/TST.** LSS accumulated data is cleared from memory. After 3 seconds the test mode is initiated.

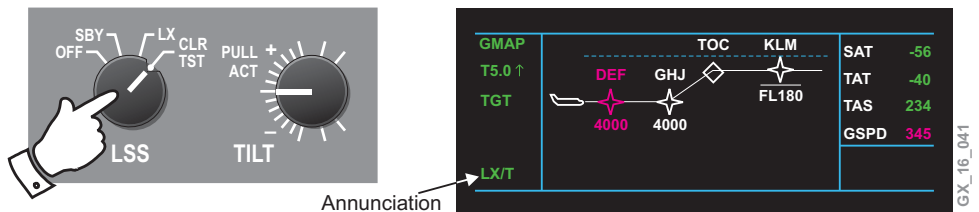

**WEATHER RADAR SCHEMATIC**

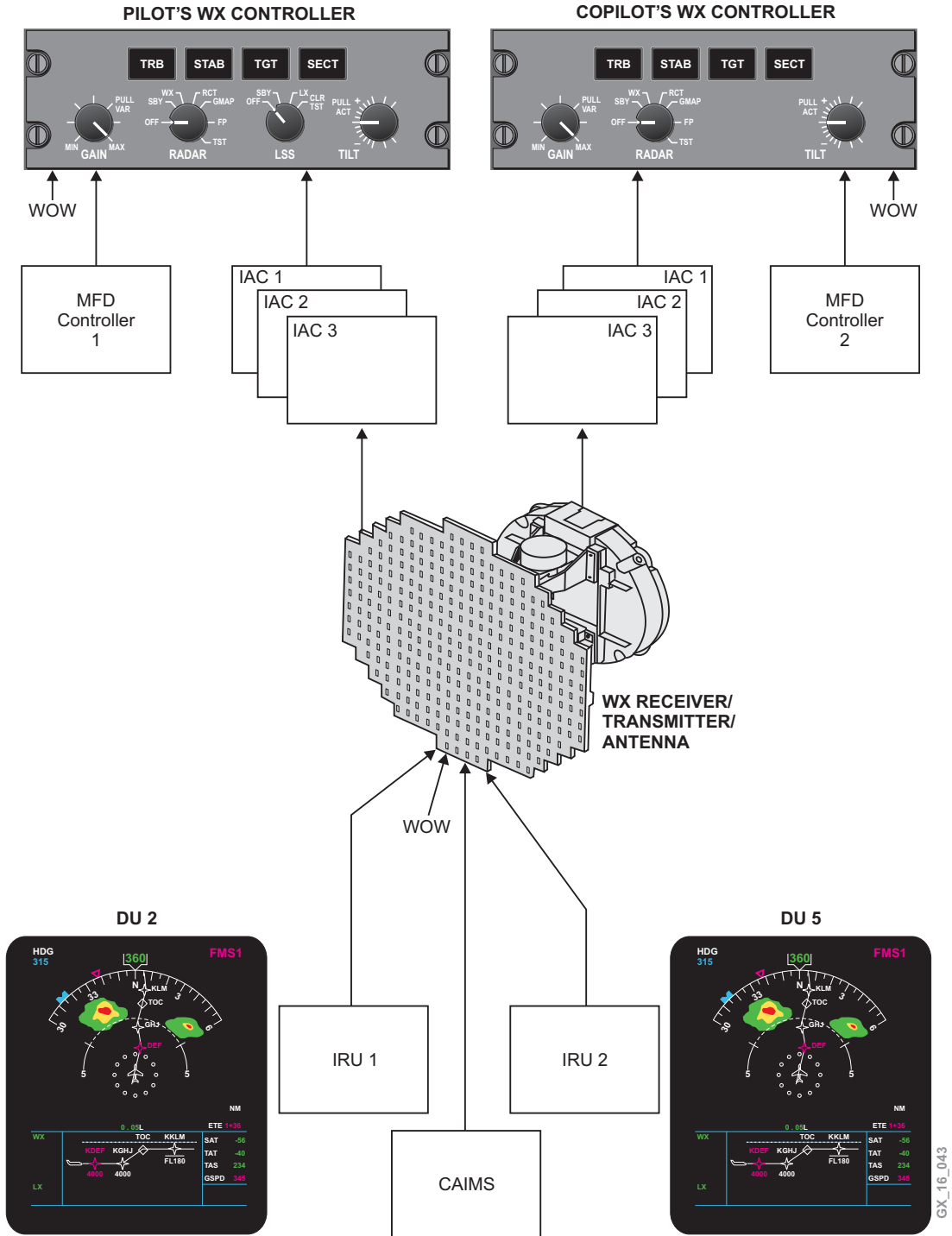

GX\_16\_043

## **TRAFFIC ALERT AND COLLISION AVOIDANCE SYSTEM (TCAS)**

The TCAS is an airborne system that interrogates ATC transponders in nearby airplanes to identify and display potential and predicted collision threats, within 700 feet of closest point of approach. TCAS monitors a radius of up to 120 nautical miles (optional above 40 miles) about the airplane, computes range, bearing and closure rate of up to 12 other transponder equipped airplanes relative to the “own” airplane. TCAS and ATC transponder modes are set on the RMUs.

Active (interrogated) range is possible up to 70 to 100 miles depending on atmospheric conditions. Passive range to a distance of 120 miles is possible if the intruder aircraft has TCAS 2000 change 7 and a GPS installed.

The system provides appropriate aural and visual cues to the flight crew when TCAS computer analysis of an airplane signal predicts a penetration of TCAS protected airspace.

### **TARGET/THREAT ADVISORIES**

The system provides four types of advisories:

- Resolution Advisory – Resolution advisories (RA) symbols (red square) appear on the MFD, when target(s) is predicted to penetrate the protected vertical envelope in less than 30 seconds. An ADI pitch target is displayed during an RA. The red avoidance zone indicates pitch targets that should be avoided and the green rectangle is the fly-to-zone. An RA can be issued if the intruder is mode C or mode S equipped. If the threat aircraft is itself equipped with mode S, a coordination procedure is performed before displaying it to the flight crew. This procedure assures that the advisories in each aircraft are compatible
- Traffic Advisory – Traffic advisories (TA) symbols (amber circle) appear on the MFD, when target(s) is projected to converge with the TCAS equipped airplane in less than 45 seconds, with the closest point of approach being inside a minimum vertical separation envelope. Traffic advisories are generated for aircraft with operative mode S, mode C, or mode A transponders. The relative bearing and range of the intruder are displayed
- Proximity Traffic – Proximity Traffic (PT) symbols (cyan diamond) appear on the MFD when non-threat airplane(s) which have a flightpath that approaches the collision area. The PT symbol is displayed if the target does not qualify for a TA but is currently within 6.5 NM and 1200 feet of the TCAS airplane
- Other Traffic – Other Traffic (OT) symbols (empty cyan diamond) appear on the MFD to indicate targets outside of the 1200-foot relative altitude region of PT, up to the TCAS range set by the pilot, and a relative altitude difference of 2,700 feet

The TCAS system provides no indication of traffic conflicts if the intruder airplane is without an operative transponder.

TRAFFIC IDENTIFICATION

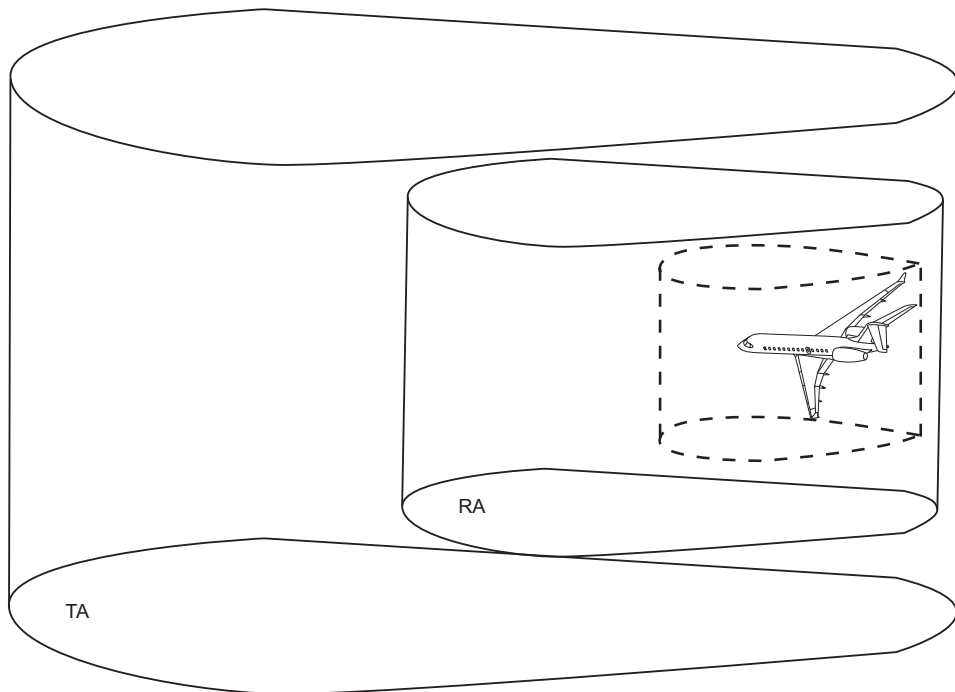
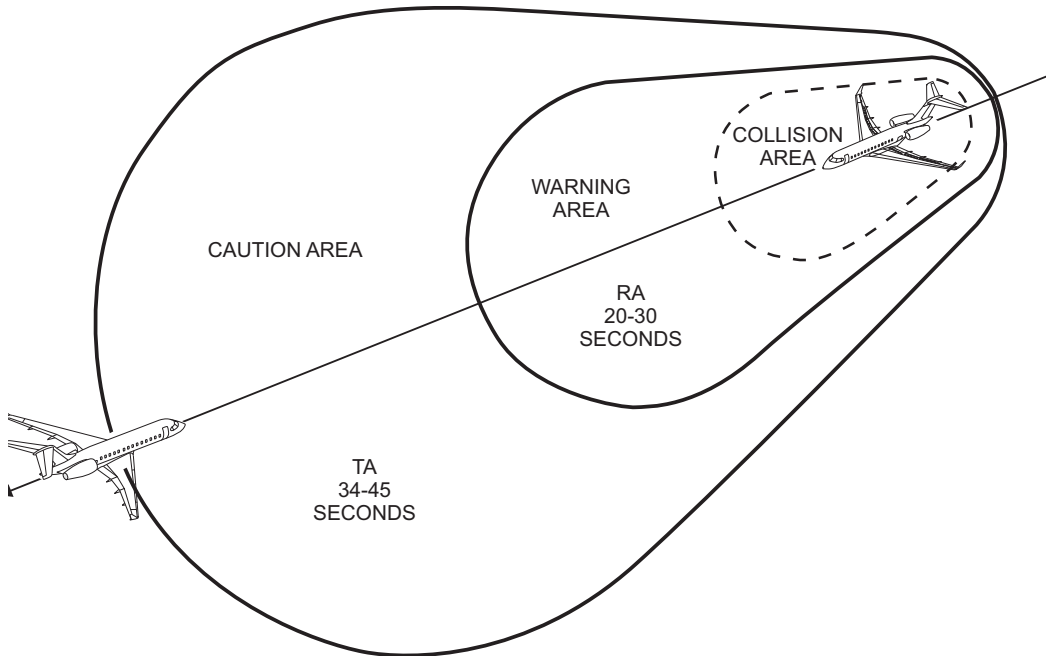

GX\_16\_044

**NOTE:**  
For every aircraft within detection range, similar Caution and Warning area patterns exist.

### TCAS MODES

The following TCAS modes are selectable on the RMU:

- TA/RA Mode – Normal operation mode providing full TCAS coverage. TCAS tracks up to 12 airplanes in the surrounding airspace and generates TAs and RAs as required
- TA ONLY Mode – TCAS tracks all PT airplanes and generates TAs, no RAs. Automatically selected when airplane is flying under 1100 feet AGL climbing and 900 AGL descending
- TEST Mode – Pressing the TST button on the RMU, will start a self-test program that will verify proper operation of the TA and RA displays and of the aural advisories. The TEST mode does not affect normal TCAS operation. Should an actual TA or RA occur during TEST sequence, the test is automatically terminated and the advisory is announced and displayed

### ATC/TCAS MODE SELECT

ATC/TCAS operations are controlled by the adjacent line keys and the tuning knobs. If the transponder code is changed on one RMU, it will also change on the other RMU. The modes are:

- ATC ON - Replies on Modes S and A, no altitude reporting
- ATC ALT - Replies on Modes A, C, and S, with altitude reporting
- STANDBY - Transponder in standby mode
- TA ONLY - TCAS traffic advisory mode selected
- TA/RA - TCAS traffic advisory/resolution advisory mode selected

**NOTE:**  
Pressing adjacent line key will annunciate STANDBY or displayed mode.

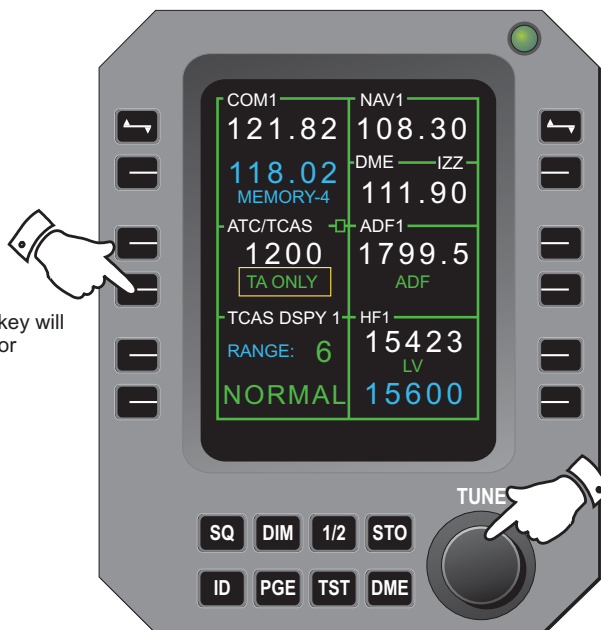

**NOTE:**  
Rotating the tuning knob will select ATC ON, ATC ALT, TA ONLY, or TA/RA

GX\_16\_045

The PGE function key provides access to a page menu. The menu allows access to the TCAS operational selections.

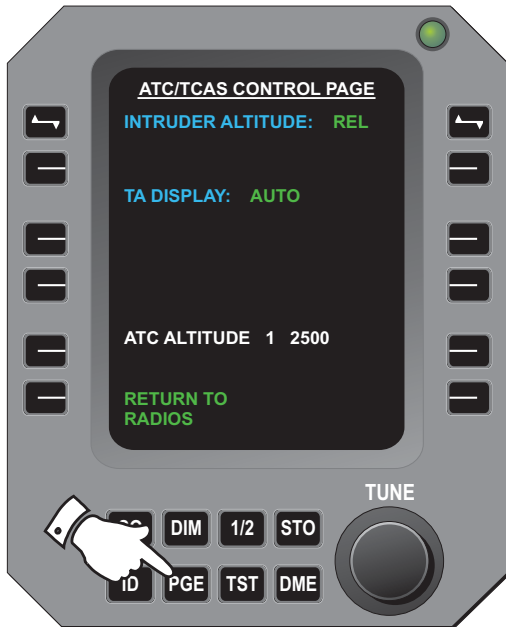

## INTRUDER ALTITUDE

**REL** Target's altitude displayed relative to one's own airplane.

**FL** Target's altitude displayed as a flight level, for 20 seconds, then returns to REL.

## TA DISPLAY

**AUTO** Traffic targets displayed only when a TA or RA target condition exists.

**MANUAL** All traffic targets displayed within the viewing airspace.

## ATC ALTITUDE

**1 (2)** Indicates that the transponder selected on the main tuning page is communicating at a displayed pressure altitude. This is not a control feature, only a cross check.

**RETURN TO RADIOS** Returns to main tuning page.

GX\_16\_046



**TCAS DSPY 1 (2) SELECT**

**Range** – Selectable at 6, 12, 20 and 40 NM.  
(80 and 120 NM optional)

**Altitude Band Select**  
**NORMAL** – With TA display set to AUTO, ± 1200 feet TCAS display altitude. With TA display set to MANUAL, ± 2700 feet TCAS display altitude.  
**ABOVE** – + 7000 feet, - 2700 feet TCAS display altitude.  
**BELOW** – 7000 feet, + 2700 feet TCAS display altitude.

**NOTE:**  
 Rotate the tuning knob to change the range when adjacent line select key is selected. Rotate the tuning knob to change the altitude band select when adjacent line select key is selected.

GX\_16\_047

**TCAS MODE SELECT ANNUNCIATION**

The indications for intruder alert and altitude band selections are as follows:

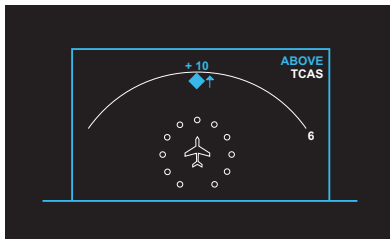

TCAS ZOOM WINDOW

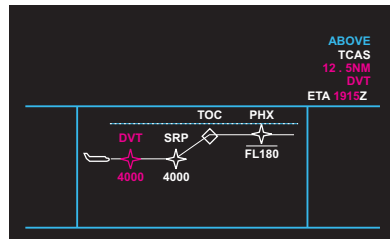

MFD (MAP FORMAT)

GX\_16\_048

The indications for TCAS TEST are as follows:

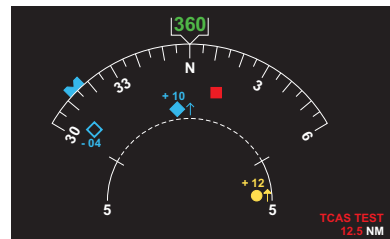
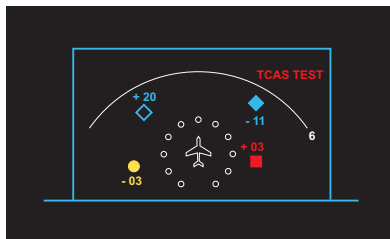

GX\_16\_049

“TCAS TEST” (when test initiated), then  
 “TCAS TEST PASS” or  
 “TCAS TEST FAIL”

**TCAS SYMBOLOGY**

| DATA TAGS      | DEFINITION  |
|----------------|---|
| Up-Arrow ↑     | Indicates climbing traffic.                               |
| Down-Arrow ↓   | Indicates descending traffic.                             |
| Plus Sign (+)  | Relative altitude threat, airplane is above own airplane. |
| Minus Sign (-) | Relative altitude threat, airplane is below own airplane. |

| THREAT LEVEL             | CAUSE   | SYMBOL |
|--------------------------|---|--------|
| Resolution Advisory (RA) | Intruding aircraft is 100 feet above and descending at least 500 feet per minute. |        |
| Traffic Advisory (TA)    | Intruding aircraft level with and not climbing or descending.                     |        |
| Proximity Traffic (PT)   | Traffic is 1,200 feet below and climbing at least 500 feet per minute.            |        |
| Other Traffic (OT)       | Traffic is 2,700 feet above and descending at least 500 feet per minute.          |        |

**DIGITIZED VOICE**

TCAS will provide voice warnings. The voice warnings cannot be canceled or reduced in volume. TA voice warning is TRAFFIC, TRAFFIC.

RA voice warnings are:

- ADJUST VERTICAL SPEED, ADJUST
- CLIMB, CLIMB
- DESCEND, DESCEND
- MONITOR VERTICAL SPEED
- CLEAR OF CONFLICT
- CLIMB, CROSSING CLIMB, CLIMB, CROSSING CLIMB
- DESCENT, CROSSING DESCENT, DESCENT, CROSSING DESCENT
- INCREASE CLIMB, INCREASE CLIMB
- INCREASE DESCENT, INCREASE DESCENT
- CLIMB – CLIMB NOW, CLIMB – CLIMB NOW
- DESCEND – DESCEND NOW, DESCEND – DESCEND NOW
- MAINTAIN VERTICAL SPEED, MAINTAIN
- MAINTAIN VERTICAL SPEED, CROSSING MAINTAIN
- CLIMB, CROSSING CLIMB – CLIMB, CROSSING CLIMB
- DESCENT, CROSSING DESCENT – DESCENT, CROSSING DESCENT



### TCAS STATUS MESSAGES

TCAS status messages are annunciated as follows:

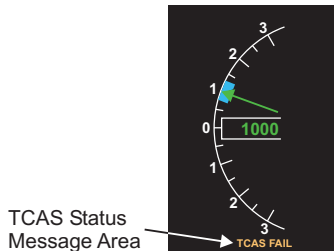

- TCAS FAIL** – Indicates TCAS failure
- TCAS TEST** – Indicates a functional test is in progress
- TCAS STBY** – Indicates TCAS is selected and transponder is in STBY
- TA ONLY** – Indicates that TCAS has been selected to traffic advisories only or below 900 AGL in a descent or below 1100 AGL in a climb.
- RA FAIL** – Indicates resolution advisory failure

GX\_16\_052

### TCAS ZOOM WINDOW

TCAS zoom window is displayed on either or both MFDs and is selected on the MFD control panel, located on the pedestal. Ranges of 6-12-20 and 40 NM (80 and 120 NM optional) can be selected by using the RMU. The 80 NM and 120 NM option is available if the Change 7 software is installed in the TCAS computer unit and TCAS range 80/120 - Enable is selected on the RMU setup page. This also requires a maintenance modification to TCAS strapping.

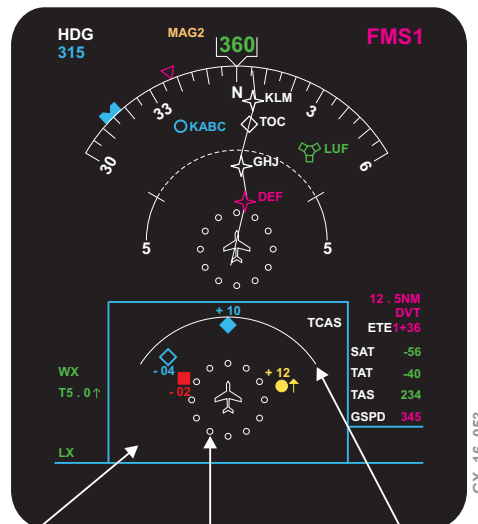

GX\_16\_053

TCAS Zoom **2 Mile Range Ring** – Only shown when range is <20 NM. When range is >20 NM, a half range arc will appear. Range Arc

**TCAS TRAFFIC DISPLAY (MAP FORMAT)**

TCAS display can also be overlaid on MAP format and is also selected through the TCAS button on the MFD control panel. TCAS cannot be displayed on PLAN format.



The button sequence is as follows:  
 NOT SHOW – TCAS ZOOM WINDOW – TCAS OVERLAY –  
 TCAS ZOOM WINDOW – TCAS ZOOM WINDOW – NOT SHOWN

**NOTE:**  
 TCAS STBY,  
 TA ONLY,  
 TCAS  
 TCAS FAIL (amber),  
 TCAS TEST (red)  
 are available annunciation.

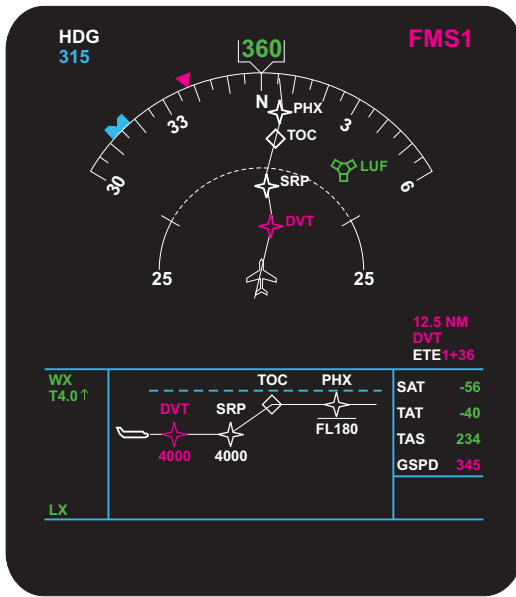

TCAS NOT SHOWN

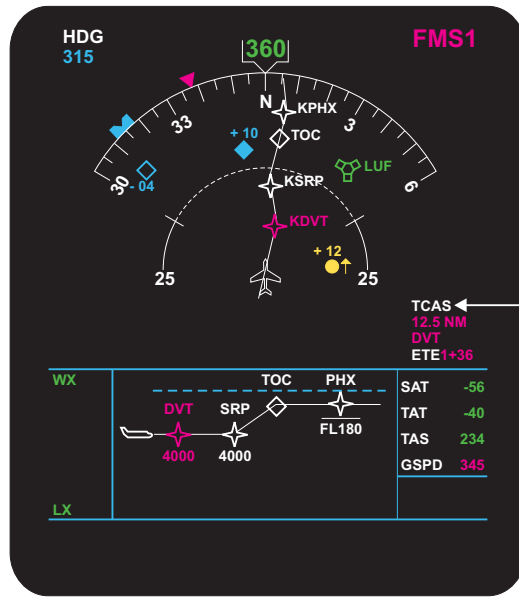

TCAS OVERLAY

**NOTE**

TCAS overlay is the default condition on the MFD on power-up.

TCAS SCHEMATIC

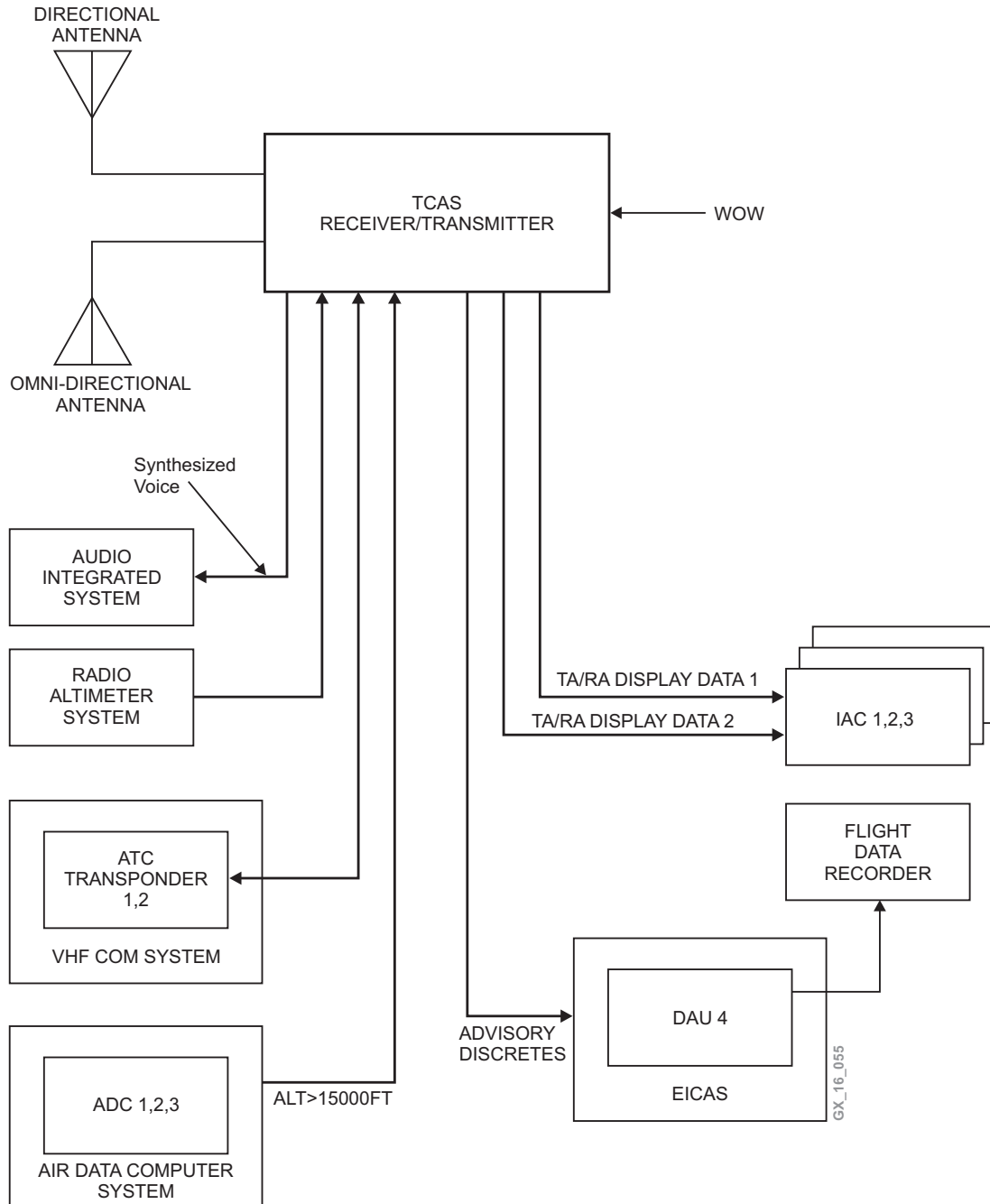

## ENHANCED GROUND PROXIMITY WARNING SYSTEM (EGPWS)

The primary purpose of the EGPWS is to provide alerts and warnings to avoid controlled flight into terrain, and to provide detected windshear warning.

The EGPWS is categorized into 7 modes. The basic GPWS function is comprised of modes 1 through 6. The windshear function and the enhanced feature, terrain awareness alerting and display function is mode 7. Mode 7 is what promotes a basic GPWS to EGPWS.

The Enhanced Ground Proximity Warning Computer (EGPWC) processes all inputs and provides all aural and visual alerts and warnings. The following priority, from highest to lowest, is used to determine which annunciation is displayed if more than one is active:



An alert annunciation indicates potential for impact with terrain. A warning annunciation indicates a prediction for impact with terrain. All annunciations are displayed on pilot's and copilot's PFDs.

The MFD control panel provides for the selection of the Terrain display on the respective MFD.

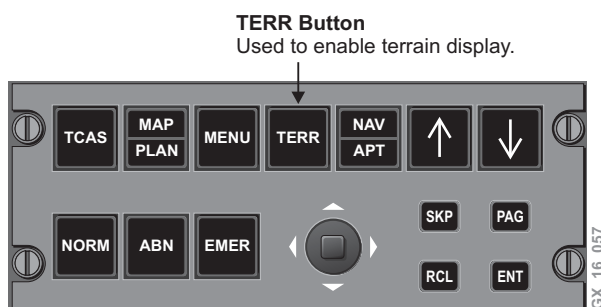

For more information, see Chapter 7, Electronic Display Systems.

## Bombardier Global Express - Navigation

The EGPWS control panel provides for the selection of G/S WARN (MUTED), FLAP OVRD (OVRD) and TERRAIN (OFF).

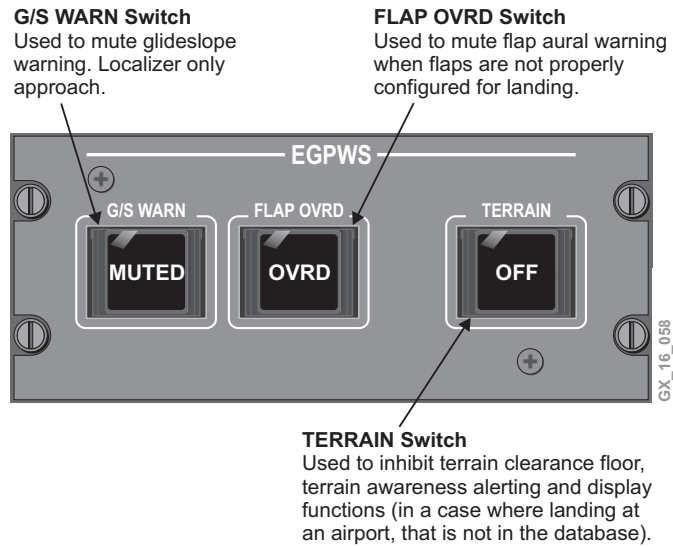



## EGPWS MODES

EGPWS modes are as follows:

### Mode 1 – Excessive Descent Rate

Mode 1 provides aural and visual alerts and warnings in the event that the EGPWC determines that the rate of descent is excessive with respect to airplane altitude. The mode is active when the airplane is less than 2500 feet AGL. Mode 1 uses radio altitude and vertical speed inputs.

The annunciation envelope consists of two areas: alert and warning.

- Penetration of the alert area will annunciate a GND PROX alert on the PFD and generate an aural “SINKRATE SINKRATE”. The aural alert will be annunciated once, and will be repeated only if condition degrades by more than 20% based on computed time to impact. The visual alert will remain until the condition is rectified
- Penetration of the warning area will annunciate a EGPWS alert on the PFD and generate an aural “WHOOOP, WHOOOP, PULL UP” warning. The aural warning is annunciated continuously until the condition is rectified

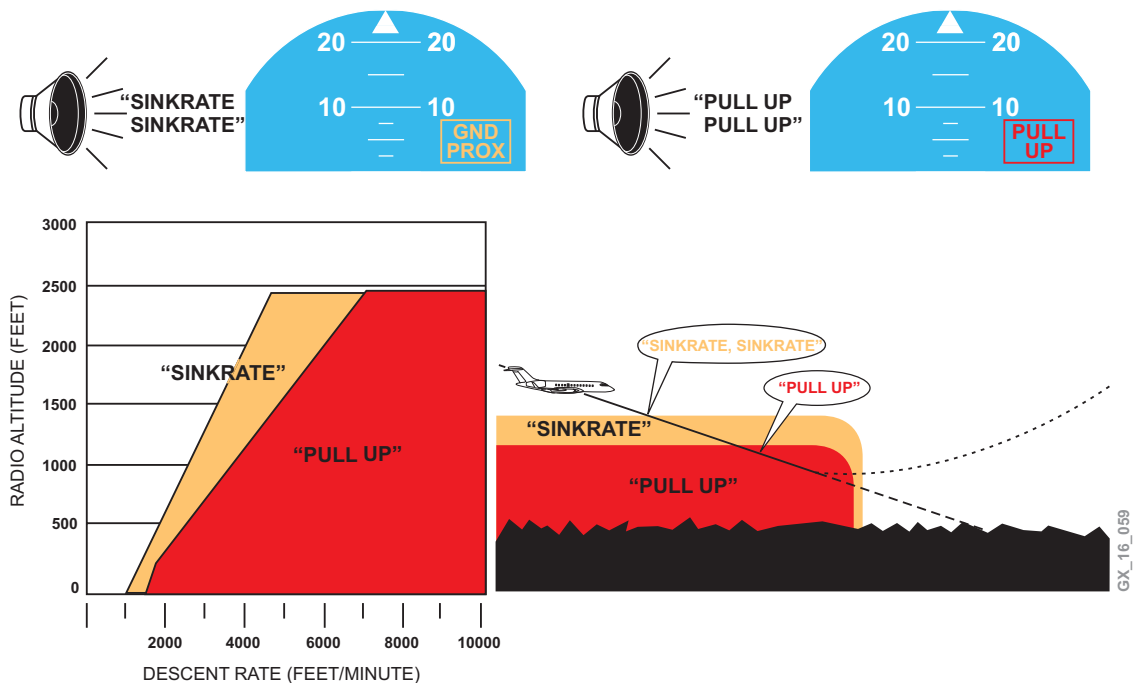

### Mode 2 – Excessive Terrain Closure Rate

Mode 2 provides alerts and warnings when the EGPWC detects that the closure rate between the airplane and terrain is excessive. The airplane need not be in descent, rising terrain may be encountered in level flight, or the terrain may be rising at a rate greater than the airplane rate of climb. Mode 2 uses radio altitude and vertical speed inputs.

Mode 2 has two submodes: Mode 2A and Mode 2B.

- Mode 2A – Activated when flaps are not in the landing position. Penetration of the alert area will annunciate a GND PROX on the PFD and generate an aural “TERRAIN, TERRAIN”. The aural is annunciated once and the visual alert will remain until the condition is rectified. Penetration of the warning area will annunciate a PULL UP alert on the PFD and generate an aural “PULL UP” warning. The aural and visual warnings are annunciated continuously until the condition is rectified

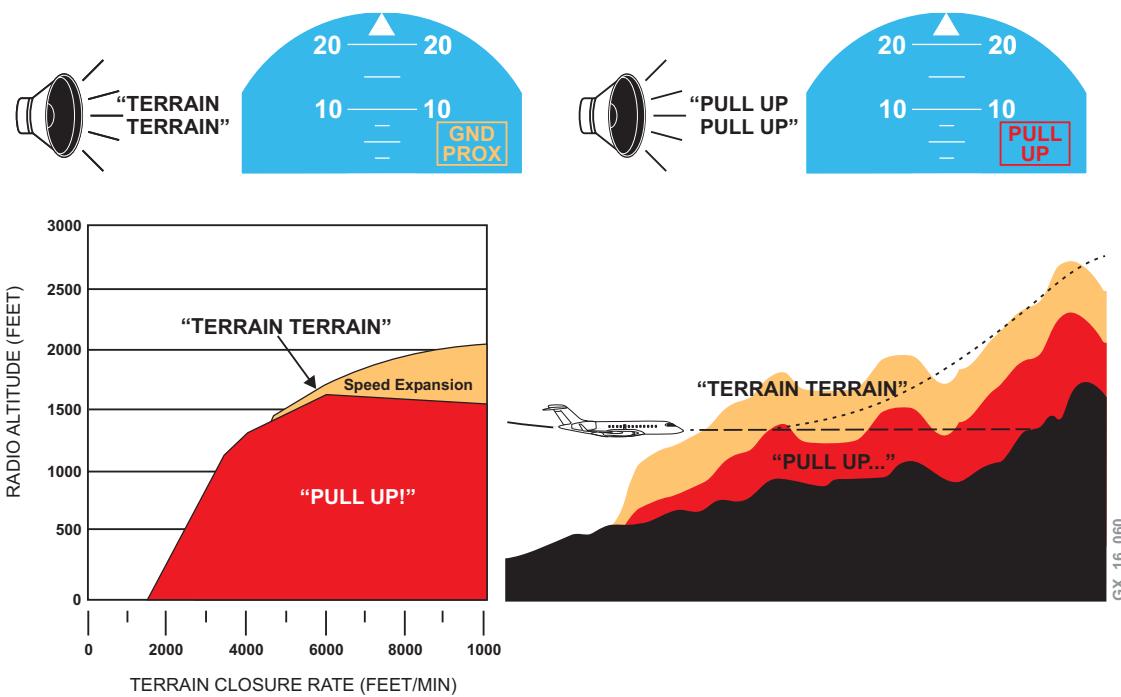

## Bombardier Global Express - Navigation

- Mode 2B – Activated when flaps are in the landing configuration, or in the event the flaps are up and the airplane is on an ILS approach and the glideslope and localizer deviations are less than  $\pm 2$  dots and for 60 seconds after takeoff. Penetration of the alert area will annunciate a GND PROX on the PFD and enable an aural “TERRAIN, TERRAIN”. The aural and the visual alerts are annunciated continuously and will remain until the condition is rectified. Penetration of the warning area will annunciate a PULL UP alert on the PFD and generate an aural “PULL UP” warning. The aural and visual warnings are annunciated continuously until the condition is rectified. The Mode 2B warning envelope is inhibited at an altitude below 30 feet AGL

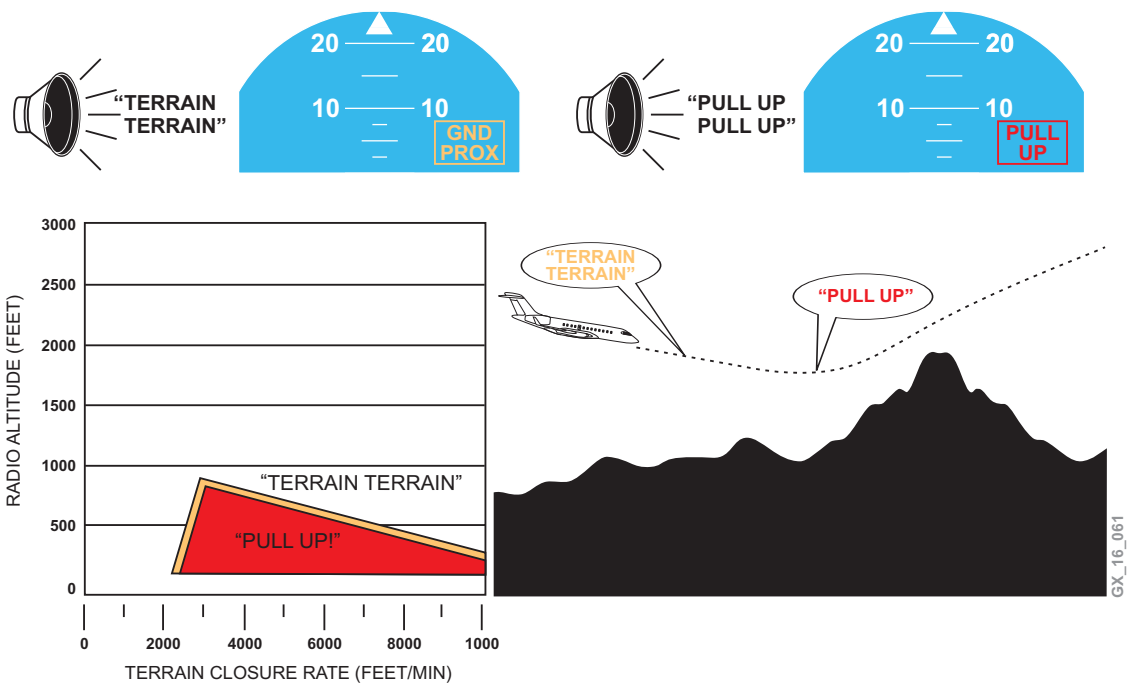

## Mode 3 – Altitude Loss After Takeoff

Mode 3 provides warnings when the EGPWC detects that a significant amount of altitude is lost immediately after takeoff or during a go-around. Mode 3 uses radio altitude, barometric altitude and altitude rate.

If a descent is initiated following takeoff or go-around, the EGPWC stores the altitude value at which the descent began, and compares successive altitude data to the stored value. Activation of the warning is induced when the minimum terrain clearance, as a function of altitude lost, is exceeded.

Penetration of the alert area will annunciate a GND PROX alert on the PFD and generate an aural “DON’T SINK, DON’T SINK” warning. The aural warning is annunciated only once, unless the altitude value degrades by more than 20% from the initially stored value, and again at each additional 20% degradation from the initially stored value. This condition will remain until the airplane regains the initial altitude value. Mode 3 is inhibited for radio altitude values in excess of 1500 feet.

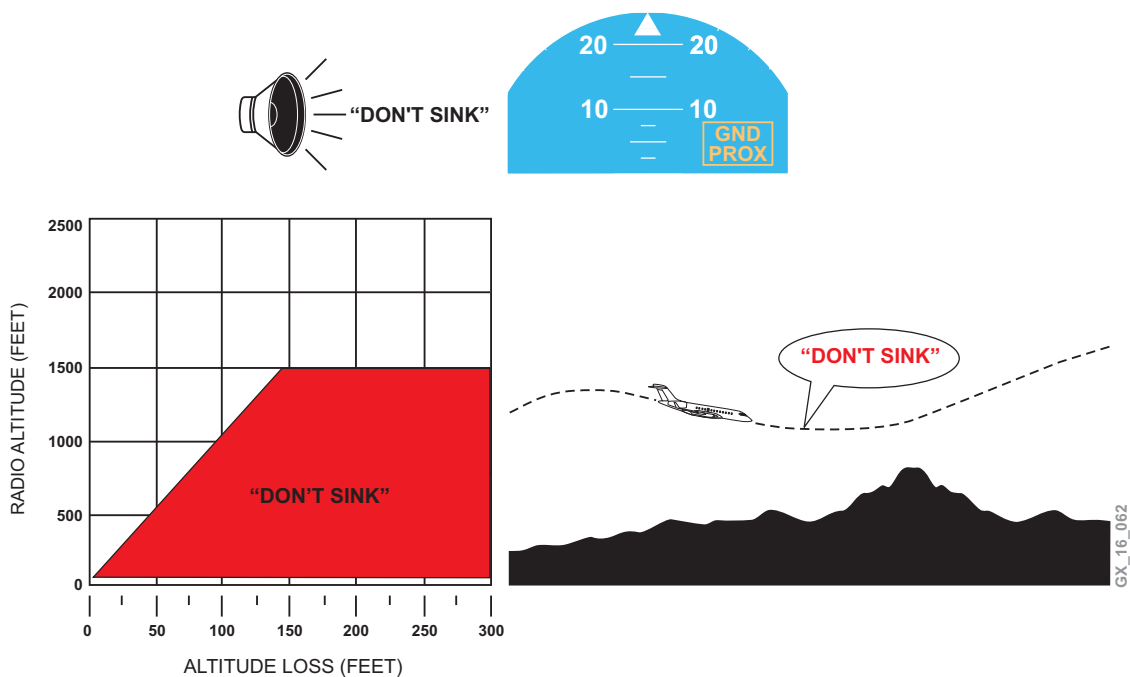

**Mode 4 – Unsafe Terrain Clearance**

Mode 4 provides alerts and warnings for insufficient terrain clearance based on airplane phase of flight and airspeed. Mode 4 requires radio altitude, computed airspeed, gear position and flap position inputs. The alert and warning envelopes are based on minimum allowable terrain clearance as a function of computed airspeed.

Mode 4 is divided into 3 submodes: Mode 4A, Mode 4B and Mode 4C.

- Mode 4A – Active when the airplane is in cruise or approach phase of flight, and the landing gear is not in the landing position. The alert envelope for Mode 4A begins at 30 feet AGL and extends vertically to an altitude of 500 feet AGL. Penetration of the alert area, above 190 knots, the upper boundary increases with airspeed to a maximum of 1000 feet radio altitude at 250 knots or more, and will annunciate a GND PROX message and generate a continuous aural “TOO LOW TERRAIN” warning. Penetration of the alert area, below 190 knots, will annunciate a GND PROX alert on the PFD and generate an aural “TOO LOW GEAR” warning. The aural and visual remain until the airplane exits the envelope

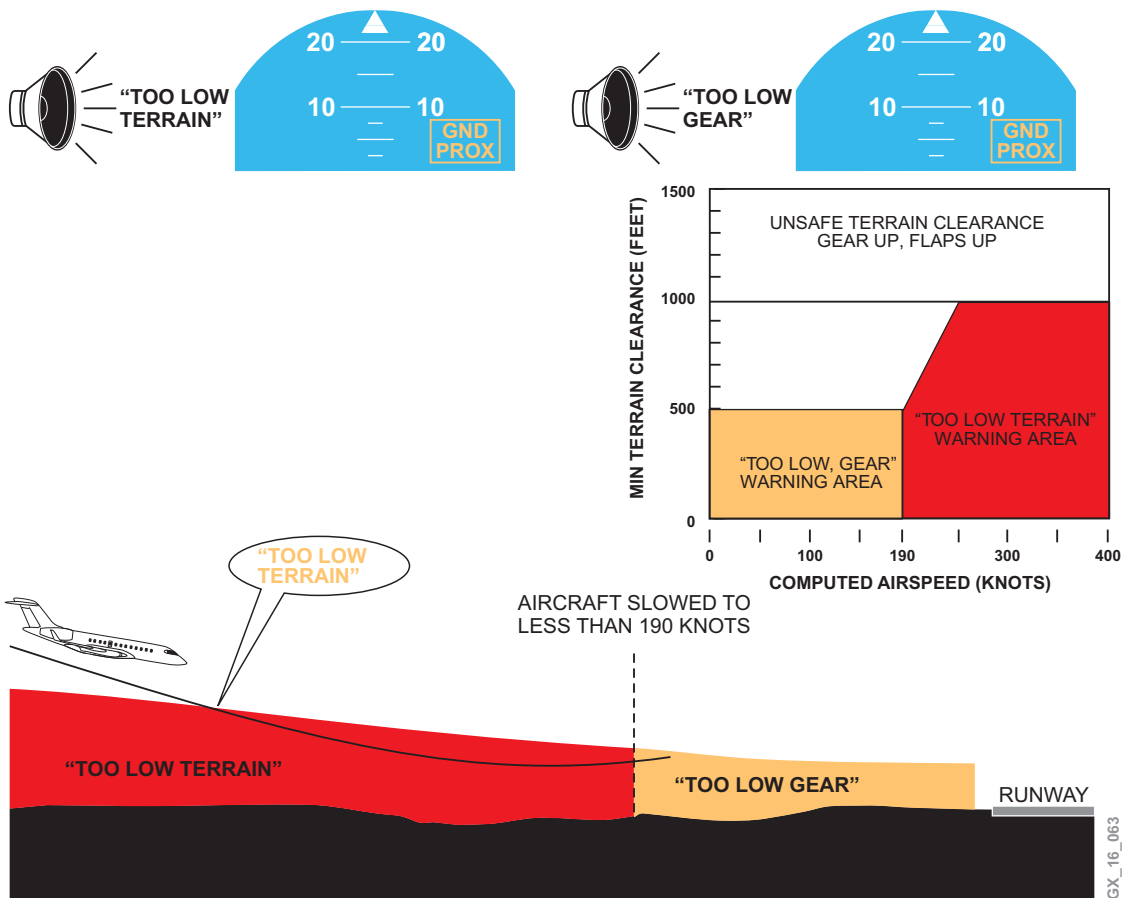

GX\_16\_063

# Bombardier Global Express - Navigation

- Mode 4B – Active when the airplane is in cruise or approach phase of flight, and the landing gear is in the landing position. The alert envelope for Mode 4B begins at 30 feet AGL and extends vertically to an altitude of 245 feet AGL. Penetration of the alert area, above 159 knots, will annunciate a GND PROX message and generate a continuous aural “TOO LOW TERRAIN” warning. The aural and visual remain until the airplane exits the envelope. Penetration of the alert area, below 159 knots, will annunciate a GND PROX message on the PFD and generate an aural “TOO LOW FLAPS” warning

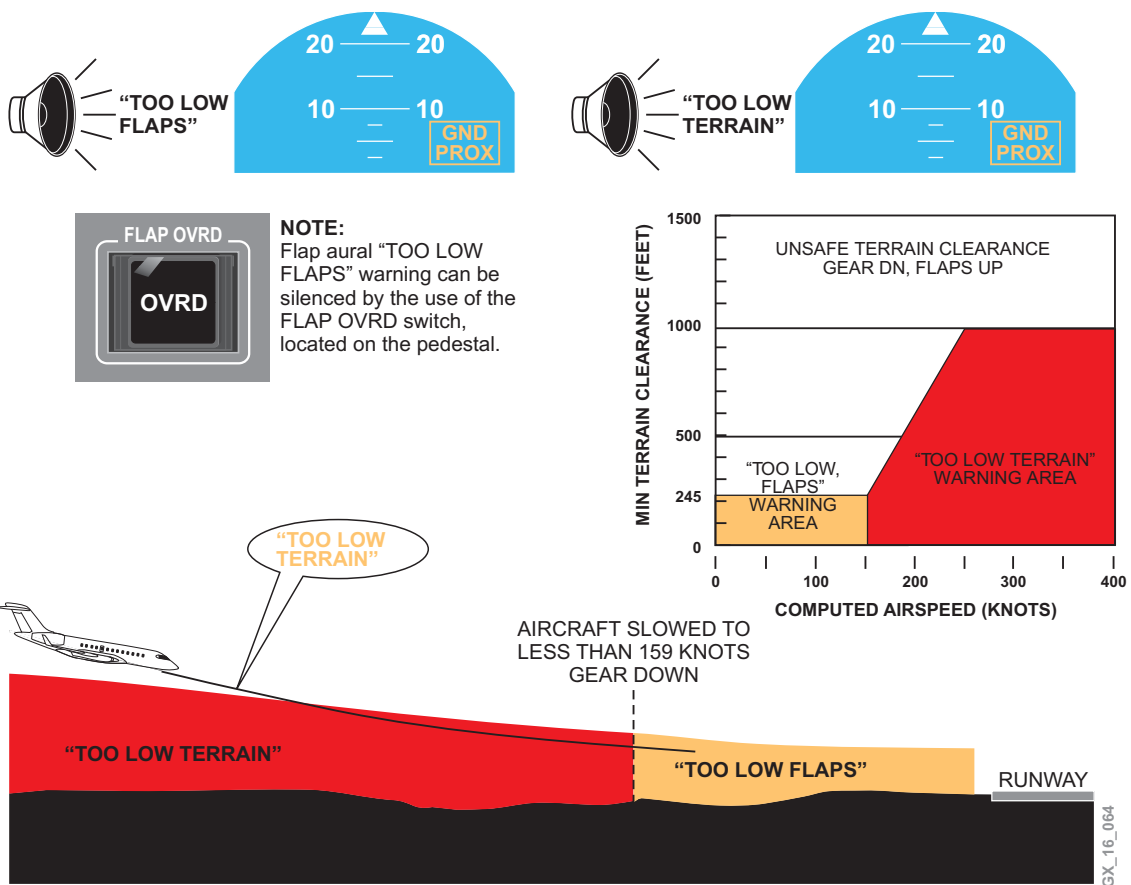

## Bombardier Global Express - Navigation

- Mode 4C is based on a minimum terrain clearance, or floor, that increases with radio altitude during takeoff. Any decrease in altitude below minimum terrain clearance will annunciate a GND PROX message and generate an aural “TOO LOW TERRAIN” warning

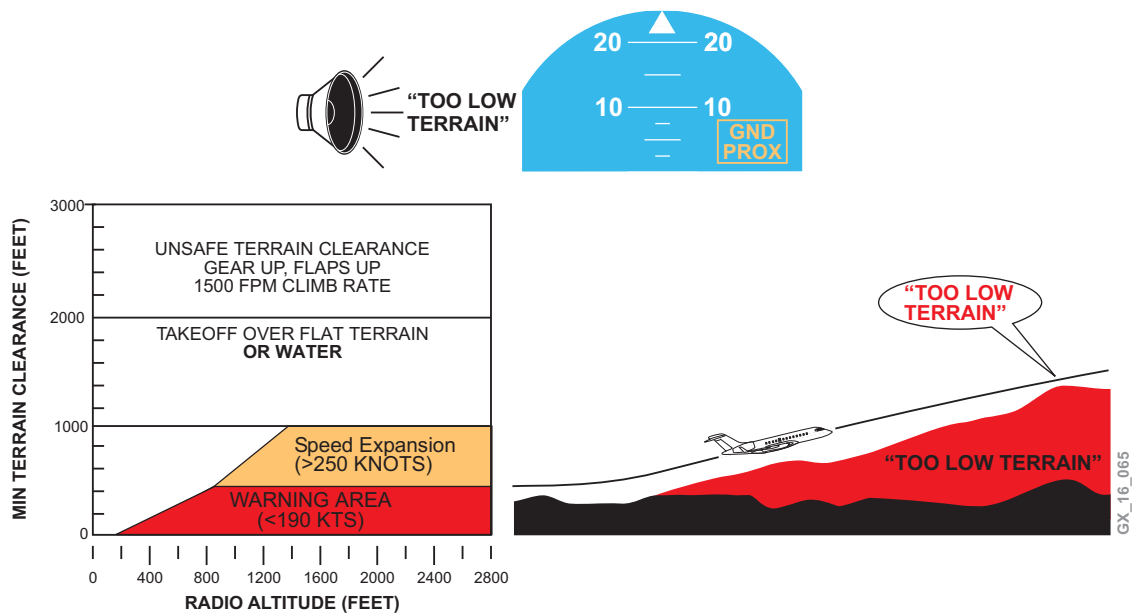

**Mode 5 – Descent Below Glideslope**

Mode 5 provides alert and warnings when the airplane descends below the glideslope on an ILS approach. The alerts and warnings are annunciated in two distinct tones, depending on the position of the airplane on the glideslope.

When the airplane descends more than 1.3 dots (but not more than 2 dots) below the glideslope, a soft (6 dB) aural “GLIDESLOPE” is generated. If the airplane continues to descend and deviates more than 2 dots below the glideslope, an aural “GLIDESLOPE” warning is generated at the same volume level as all other warnings. A GND PROX message is annunciated on the PFD. The aural and visual alerts and warnings are continuously annunciated until the airplane exits the alert envelope.

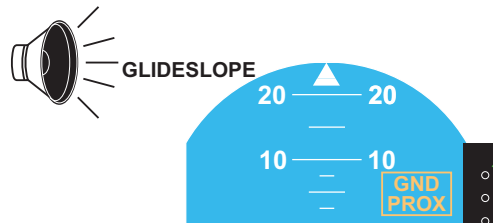
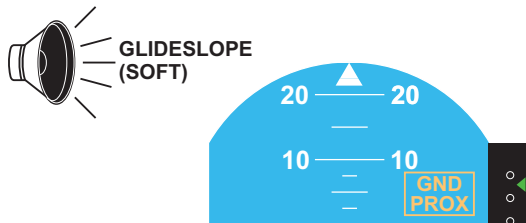

**NOTE:**  
The “GLIDESLOPE” aural warning can be muted, using the G/S WARN switch on the pedestal.

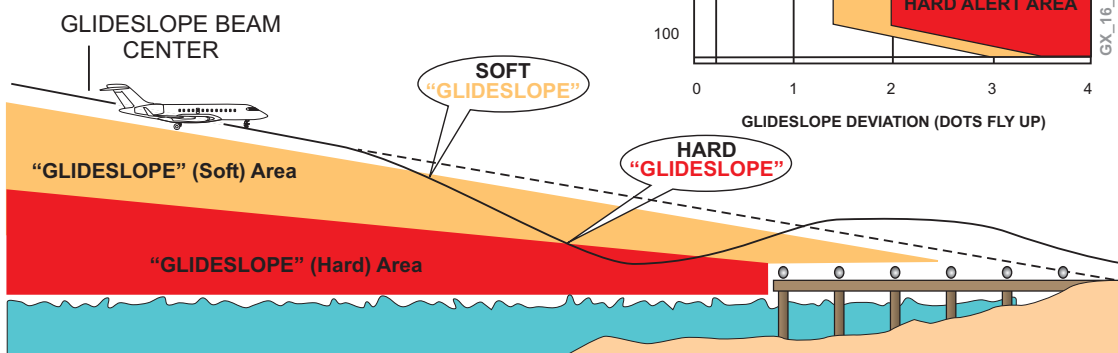
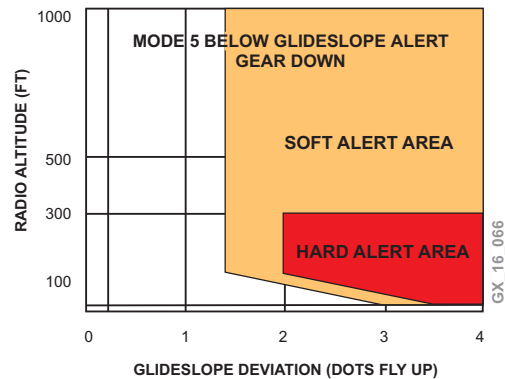



### Mode 6 – Callouts

Mode 6 provides the following advisory alerts: transition through approach minimums, altitude callouts on approach and excessive bank angles.

- Transition through the preset approach minimums, generates an aural “MINIMUMS, MINIMUMS” warning. The warning function is enabled between 1000 feet and 10 feet radio altitude for DH minimums. The landing gear must be down for activation of the warning
- An altitude callout function generates annunciation for descent below predetermined altitudes. The aural “ONE HUNDRED”, “FIFTY” and “THIRTY” indicates the transition through 100, 50 and 30 feet AGL. The last annunciated or transition altitude is memorized. This will prevent the repeat annunciation of a callout should the airplane transition through said altitudes again. The memory is cleared and reset, once the airplane climbs to an altitude greater than 1000 feet, or in the event a transition occurs from approach mode to takeoff mode.
- A “smart altitude callout” provides an aural “FIVE HUNDRED” at 500 feet radio altitude during a nonprecision approach. The callout may be generated during a precision approach if the airplane flightpath deviates greater than + 2 dots of either the glideslope or localizer. The callout is also generated during a back course approach. Note that these callouts can be programmed as required

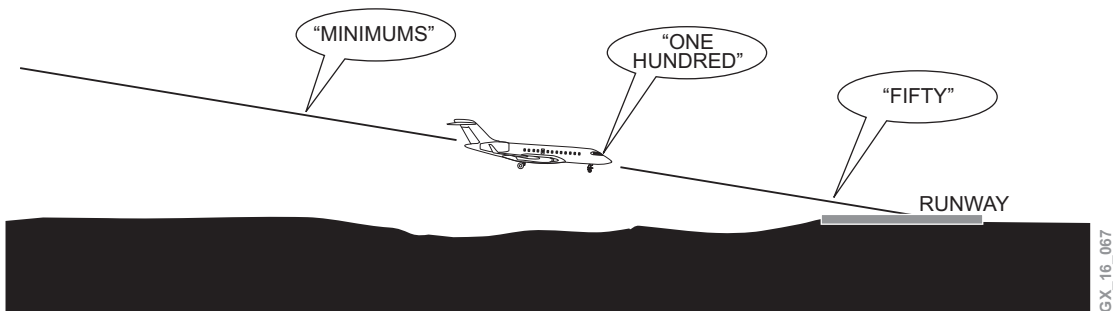

GX\_16\_067

- The excessive bank angle alert is a function of the roll angle with respect to altitude above ground level. The alert envelope varies linearly from a 10° bank at 30 feet AGL and to 40° of bank at 150 feet AGL, to 55° of bank at 2450 feet AGL. This will generate an aural “BANK ANGLE, BANK ANGLE”. The alert is annunciated once, and will repeat if the bank angle increases by 20%. The alert will be annunciated continuously if the bank angle is increased to 55°. The alert will be annunciated until the bank angle is decreased below said value

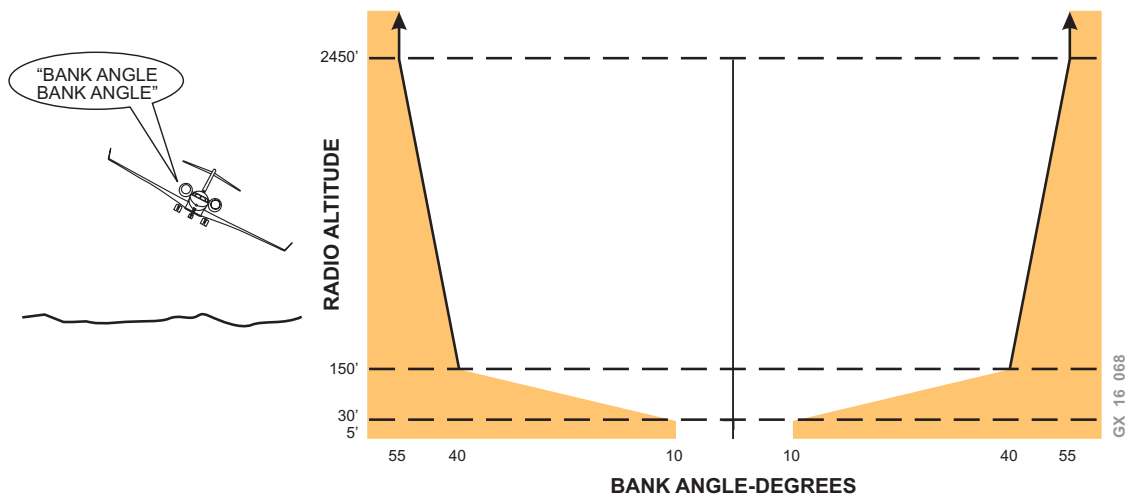

### Mode 7 – Windshear Warning

Mode 7 provides alerts and warnings in the event that significant windshear is detected by the EGPWC. Mode 7 is active during takeoff and landing phases of flight only, between 10 and 1500 feet AGL. There are two types of windshear warnings: increasing performance (updraft/headwind) and decreasing performance (down draft/tailwind).

- For an increasing performance shear (updraft/headwind), an amber increasing performance shear WINDSHEAR message is annunciated on the PFD and flashes for 5 seconds, then remains steady
- For a decreasing performance shear (downdraft/tailwind), a decreasing performance shear WINDSHEAR message in red is annunciated on the PFD and flashes for 5 seconds, then remains steady, and an aural siren and “WINDSHEAR, WINDSHEAR, WINDSHEAR” warning are activated.



## Bombardier Global Express - Navigation

When a terrain threat is detected, an aural “CAUTION TERRAIN, CAUTION TERRAIN” is generated and GND PROX is annunciated on the PFD. When alerts are activated, areas which meet the terrain threat, alert criteria are depicted yellow.



**NOTE:**  
If in PLAN mode and auto pop-up occurs, MFD format will automatically change to MAP mode, with the terrain map displayed.

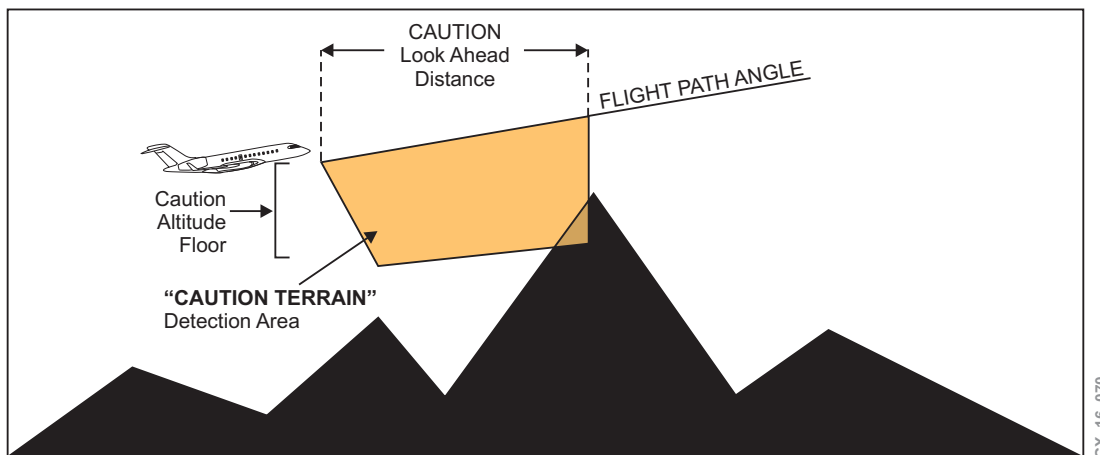

When a collision with terrain is predicted, an aural “TERRAIN, TERRAIN, PULL UP, PULL UP” warning is generated and PULL UP is annunciated on the PFD. When warnings are activated, areas which meet the terrain collision alert criteria are depicted red. Terrain will automatically pop up, in MAP mode, on MFD at a 10 NM range, if there is a terrain warning at 30 seconds from impact.

# Bombardier Global Express - Navigation



“TERRAIN, TERRAIN  
PULL UP, PULL UP”

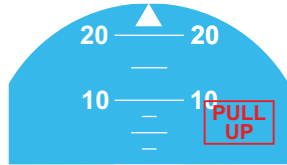

**NOTE:**

If in PLAN mode and auto pop-up occurs, MFD format will automatically change to MAP mode, with the terrain map displayed.

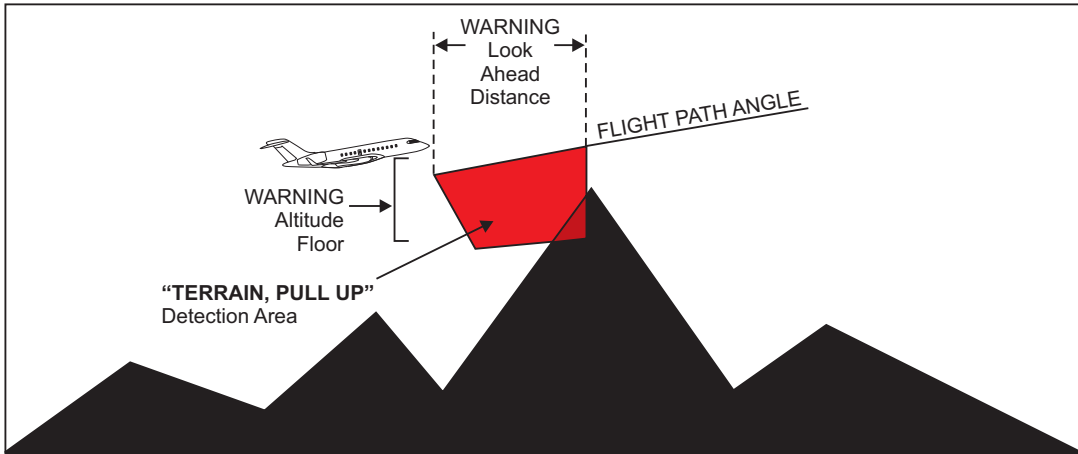
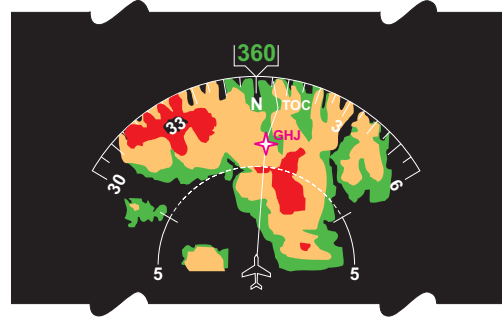

GX\_16\_071

## ANNUNCIATIONS

All terrain annunciators are displayed on the MFD. The annunciators are as follows:

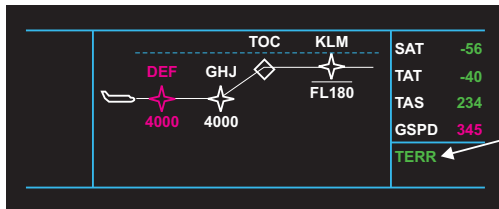

- TERR** Terrain has been selected.
- TERR TEST** Indicates a self-test.
- TERR FAIL** Internal failure or loss of communication with EFIS
- CNTRL FAIL** Indicates loss of range control for terrain map
- TERR N/A** Position uncertain
- TERR INHIBIT** Terrain clearance floor, terrain awareness alerting and display functions.

GX\_16\_072

### TERRAIN CLEARANCE FLOOR (TCF)

The TCF function supplements the EGPWS function by providing an additional terrain clearance alert envelope around airports. The TCF criteria is used to determine alert and warning envelopes.

TCF creates an increasing terrain clearance envelope around the intended airport runway directly related to the distance from the runway. TCF alerts are based on current airplane location, nearest runway center point position and radio altitude, along with an integral database that includes all worldwide, hard-surfaced runways greater than 3500 feet in length.

Penetration of the alert envelope will generate an aural “TOO LOW TERRAIN” and a GND PROX message is displayed on the PFD. The aural alert is repeated twice, and again thereafter if the radio altitude value decreases by more than 20% from the altitude at which the initial warning was issued. The EGPWS message remains displayed until the airplane exits the alert envelope.

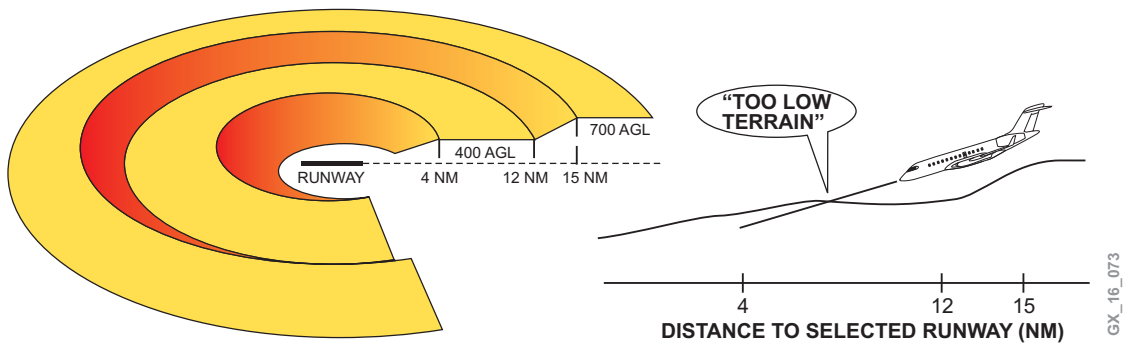
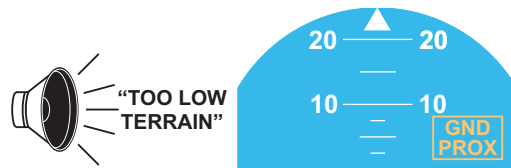

### NOTE

In a case where landing at an airport that is not in the database, all TERRAIN functions can be inhibited, by selecting the TERRAIN switch, located on the overhead panel.

## FLIGHT MANAGEMENT SYSTEM (FMS)

The FMS performs the functions of navigation, flight planning and guidance of the airplane throughout the full flight regime in both Lateral Navigation (LNAV) and Vertical Navigation (VNAV).

There are two Control Display Units (CDU), located on the pedestal. A third FMS (optional) can also be installed on the pedestal. The displayed data is shown in the following colors:

- Cyan (vertical & atmospheric data)
- Green (lateral and index selections)
- Yellow (FROM waypoint)
- Magenta (TO waypoint)
- Orange (flight plan names)
- White (prompts and titles)

## FMS DISPLAY UNIT

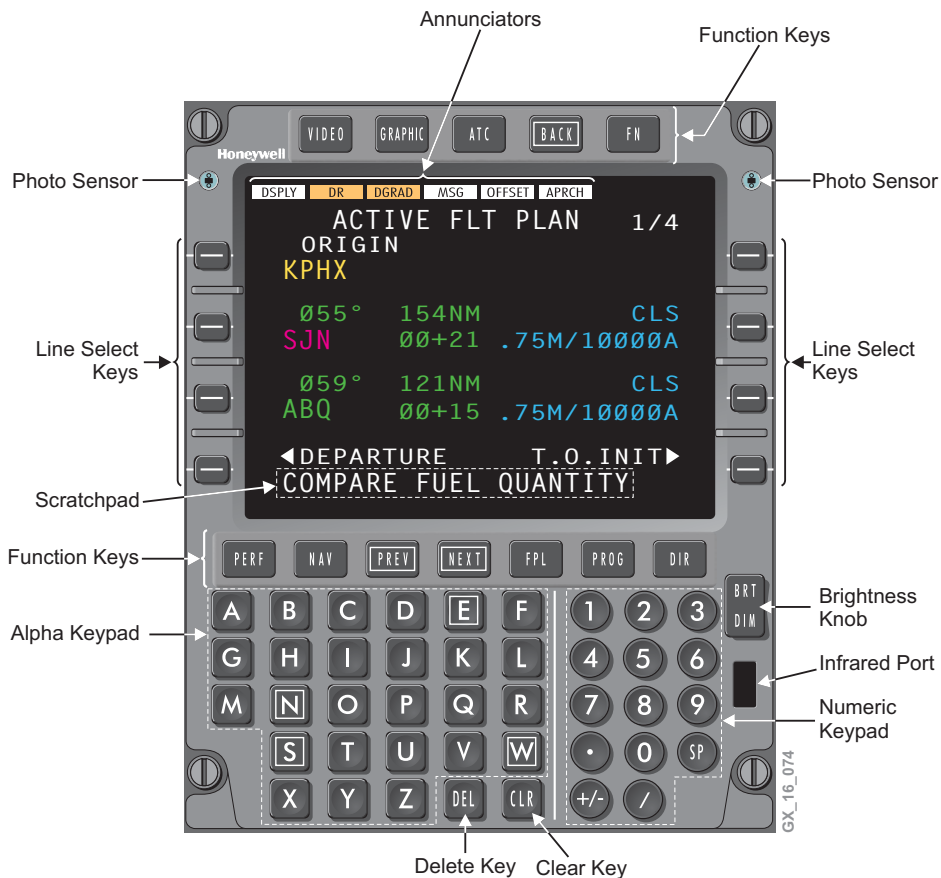

## ANNUNCIATORS

There are six annunciators located at the top of the Control Display Unit (CDU). White annunciators indicates an advisory annunciation, amber annunciators indicate an alerting annunciation.

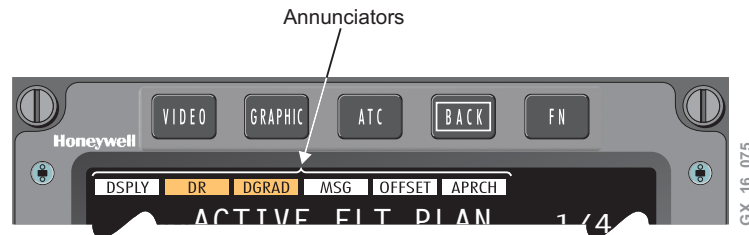

The annunciators are:

- **DSPLY (Display)** – is lit when the CDU displays:
  - A flight plan page other than the first page of the active flight plan
  - A stored flight plan page
  - Any of the review pages for SIDs and STARs approaches
  - A change active leg message
  - An intercept waypoint is being defined on the active leg
- **DR (Dead Reckoning)** – is lit when operating in the DR mode for longer than 2 minutes. The DR mode is defined as the loss of radio updating and all other position sensors (IRS and GPS)
- **DGRAD (Degraded)** – is lit when the FMS cannot guarantee the position accuracy for the present phase of flight due to sensor availability. If the DR annunciator is lit when DGRAD is lit, DGRAD annunciator goes out. The annunciator is lit if both of the following conditions are valid:
  - The sensors being used to navigate are not approved for the current phase of flight
  - The FMS is the selected navigation source on EFIS
- **MSG (Message)** – is lit when a message is displayed in the scratchpad. Messages are displayed in the CDU scratchpad to inform or alert the pilot as to the system status. The annunciator goes out after the message(s) has been cleared from the scratchpad. For a list of FMS messages, refer to the Flight Management System Pilot's Guide. Messages are divided into two groups:

- **Advisory messages** – Are usually the result of a pilot action on the CDU

INVALID ENTRY

- **Alerting messages** – Alert the pilot to FMS status

COMPARE FMS POSITIONS



- OFFSET (Offset) – is lit when a lateral offset has been entered on PROGRESS page. The annunciator goes out when the offset is removed
- APRCH (Approach) – indicates that FMS is in the approach mode of operation. APRCH is lit when all of the following conditions are valid:
  - The FMS is the selected navigation source on EFIS
  - A nonprecision approach has been activated other than LOC or LOC (BC)
  - The airplane position is between 2 NM outside the final approach fix (FAF) and the missed approach point
  - The FMS must be using approved sensors for the selected approach procedure (VOR/DME, DME/DME, GPS)
  - The DGRAD annunciator must be off

### BRIGHTNESS CONTROL

Both the manual and automatic (photo sensor) brightness controls are used to increase or decrease the CRT display brightness. When selected manually, a bright/dim bar is displayed in the scratchpad. The bright/dim bar level is controlled by pressing BRT or DIM. After the adjustment is made, the photo sensors monitor the ambient light and maintain the brightness level over various lighting conditions.



## LINE SELECT KEYS

Data is selected to a line from the scratchpad or vice-versa using the line select keys. These keys are identified from top to bottom as 1L through 4L on the left side and 1R through 4R on the right side.

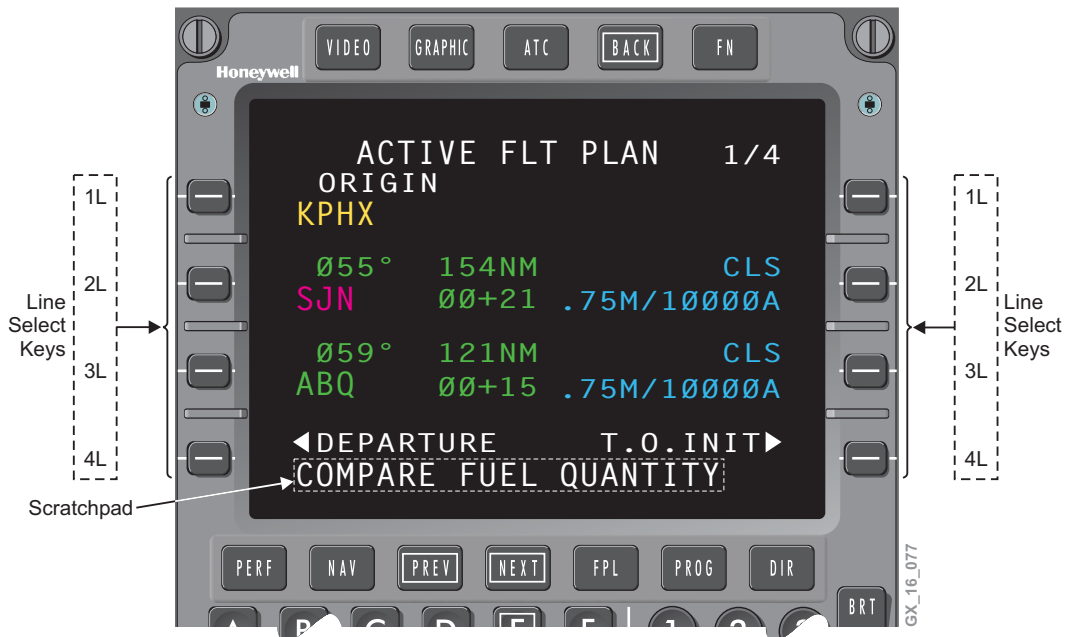

The line select keys are used for:

- Direct Access Prompts/Function Selects – In the case of a NAV or PERF index display (see function keys), the line select keys are used to select functions from the index. In displays other than index, keys 4L and 4R are primarily used for direct access to other functions in the FMS. The functions that are most likely to be accessed from the present page and phase of flight are displayed as prompts
- Transfer Line Data to Scratchpad – If the scratchpad is empty, pushing a line select key transfers the respective line data to the scratchpad
- Transfer of Scratchpad Data to Line Fields – Once data has been entered into the scratchpad, either through line selection or manual keyboard entry, it can be selected to any of the allowable line select fields on a page

## LEGEND

The following conventions are used in this section to indicate actions, results and sequences:



### Push a Function Key or Line Key

The finger indicates to push a function or line key.



### Sequence of Actions

Circled numbers show sequences for graphic images and their relationship to written steps of text. Must be followed in sequence to achieve desired results.



### Result of Action

Points to expected result of an action. Unexpected results may indicate incorrect key inputs.

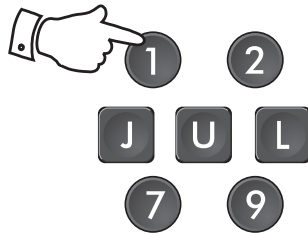

### Sequence of Keys to Push

Indicates that a series of key inputs are required. Push data keys from left to right, top to bottom.



### Specific Display Result (boxed area)

Indicates where to look for expected result.



### Specific Display Result - Scratchpad Entry (Brackets)

Locates the scratchpad display line on a figure.



### Clear Key

Used to clear data from scratchpad

GX\_16\_078

## NOTE

For more information, refer to the Flight Management System Pilot's Guide.

## FUNCTION KEYS

The seven function keys access primary functions, menus and paging.



The function keys are as follows:

- **PERF (Performance) Key** – Pushing the PERF function key displays page 1 of the performance index. Any functions can be selected by pushing the respective line select key. To view the next page of PERF INDEX push NEXT function key

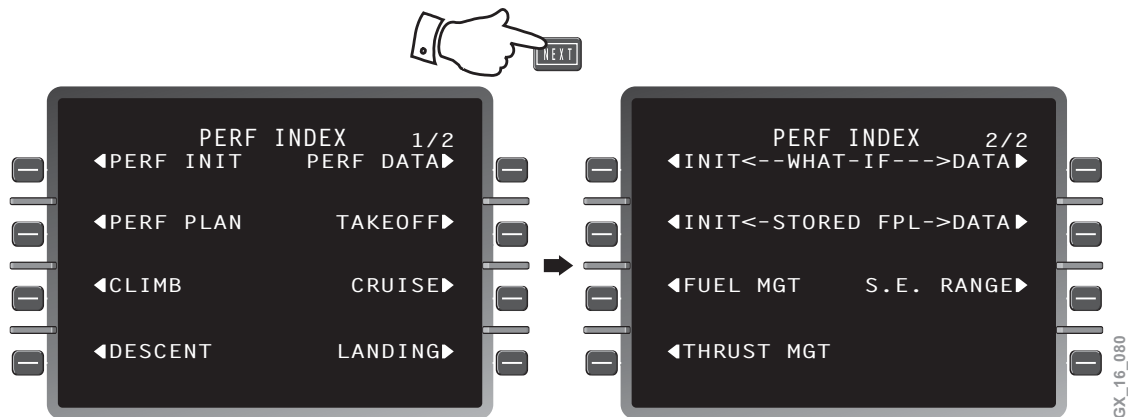

- **NAV (Navigation) Key** – Pushing the NAV function key displays page 1 of the navigation index. Any functions can be selected by pushing the respective line select key. To view the next page of NAV INDEX push NEXT function key

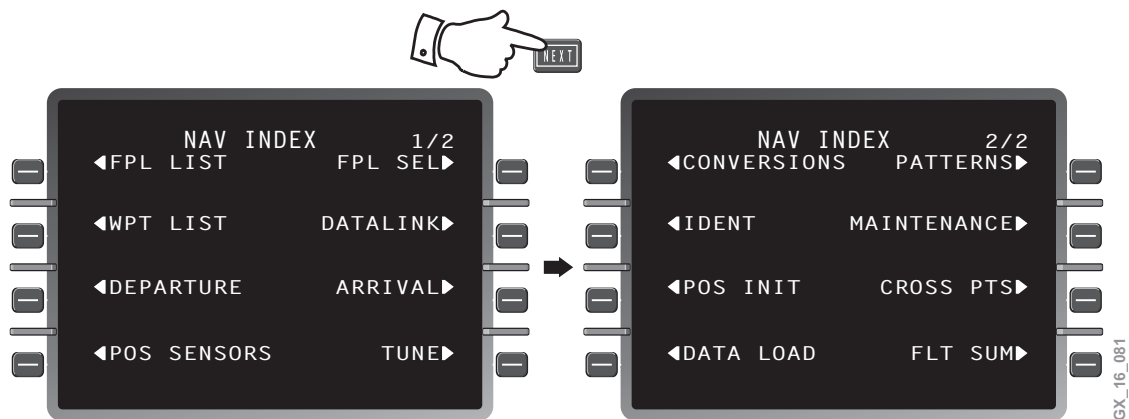

## Bombardier Global Express - Navigation

- PREV and NEXT (Paging) Keys – The specific page and number of pages in a particular function or menu display are shown in the upper right hand corner of the display. Page changes are made by pushing the PREV (previous) and NEXT keys. The keys can be held down for repeated page changing
- FPL (Flight Plan) Key – Pushing the FPL key displays the first page of the active flight plan, even if another page of the active flight plan is being displayed. If there is no flight plan entered, the pilot can:
  - Manually create a flight plan
  - Select a stored flight plan
  - Load a flight plan from a disk
  - Create a stored flight plan

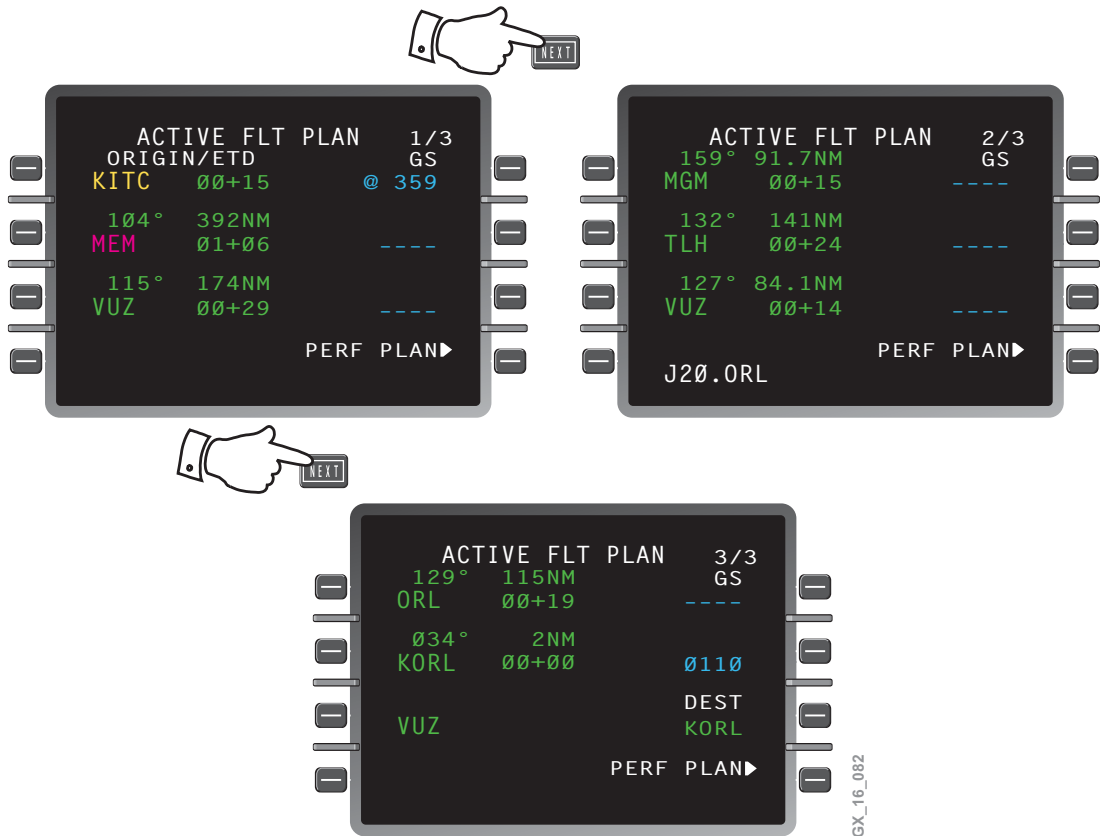

- PROG (Progress) Key – Pushing the PROG key displays the current status of the flight. There are three progress pages that report progress along the flight plan. These pages summarize important flight parameters and the airplane's relationship to the flight plan
  - The first progress page displays estimated time enroute (ETE), distance to, and fuel projection for the TO waypoint and destination. It also displays the current NAV mode, the number of long range NAV sources used and the nav aids that are presently tuned for radio updating

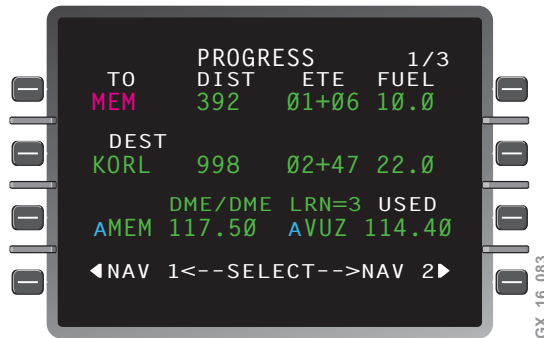

- The second progress page reflects changes based on inputs to the VNAV FMS function. The speed/altitude command (SPD/ALT CMD) reflects the current command of speed/altitude that the FMS is sending to the flight guidance computer. If there is no command, the line is titled but blank. The 1R line select displays the expected vertical speed when a path has been defined in VNAV. Otherwise, this position is blank

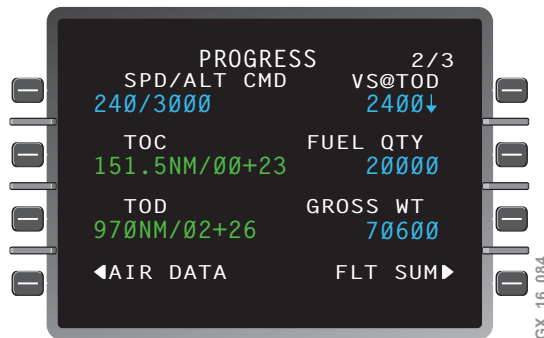

- The third progress page displays cross track error (XTK ERROR), lateral offset, current track and heading in magnetic or true, current wind in vector form and component form, drift angle and groundspeed

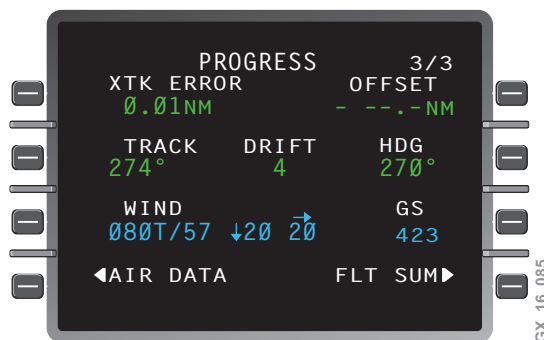

- The AIR DATA page displays the values for the on-side ADC. If the on-side ADC fails, the information comes from the off-side ADC. The ADC source is displayed on the title
- The Flight Summary FLT SUM displays flight information, fuel used, average TAS/GS and total distance both air and ground

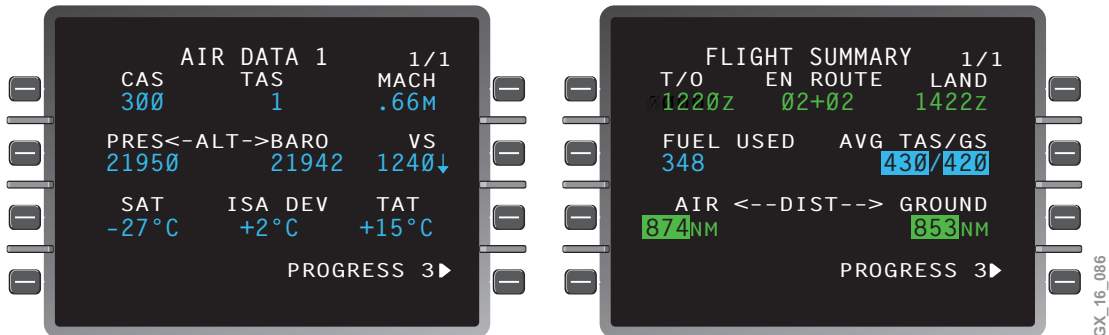

- DIR (Direct-to/Pattern/Intercept) Key – Pushing the DIR function key inserts DIRECT, PATTERN and INTERCEPT prompts on the ACTIVE FLT PLAN pages. If other than an active flight plan page is displayed when pushing the button, the first page of the flight plan is displayed. If the active flight plan is already displayed, it will remain on the current page of the flight plan
- DIRECT – The FMS DIRECT-TO function can either be lateral or vertical. The left line select keys are used for lateral and the right line select keys are used for vertical direct-to
  - Lateral DIRECT-TO – computes the turn and the course from the end of the turn. If the direct-to waypoint is in the flight plan, pushing the line select key next to the direct-to waypoint engages the direct-to. A direct-to course is calculated and the airplane begins turning for the waypoint
  - Vertical DIRECT-TO – is connected to an altitude constraint at a waypoint in the flight plan. The altitude constraint must be in the flight plan before the vertical direct-to is done. Vertical DIRECT-TO can be used for climbs and descents. The airplane does not respond to the vertical DIRECT-TO unless the altitude selector is properly set at or above for climbs and at or below for descents

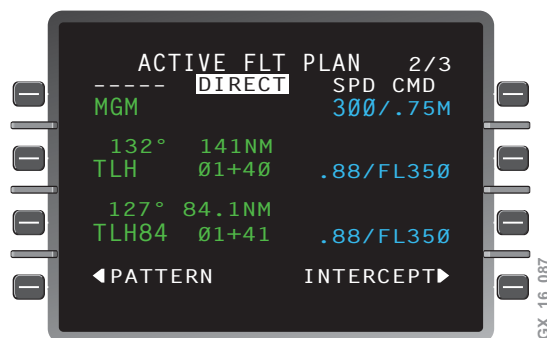

- **PATTERN** – The PATTERN prompt is used to start the pattern definition or review procedures. PATTERN can also be selected from the NAV INDEX. The following patterns are available, HOLD, PROCEDURE TURN, FLYOVER, ORBIT and RADIAL

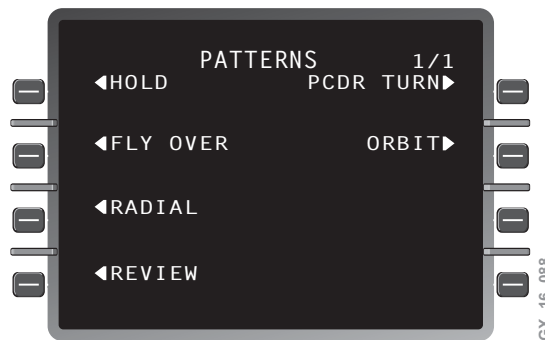

- **INTERCEPT** – INTERCEPT is used to define an intercept waypoint inserted in the flight plan between two other waypoints. The crossing of these two courses is the intercept waypoint

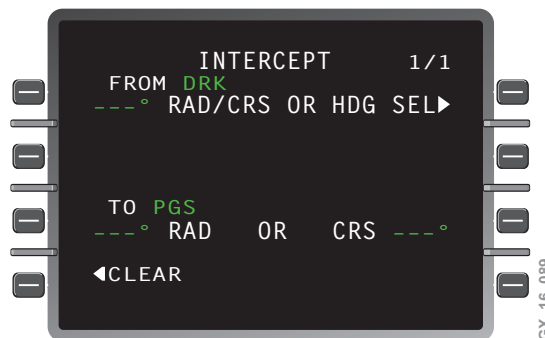

### SCRATCHPAD

The scratchpad is a working area where the pilot can enter data and/or verify data before line selecting the data into its proper position. Alphanumeric entries are made into the scratchpad using the keyboard. As each key is pushed, the character is displayed in the scratchpad. Information in the scratchpad does not affect FMS until it is moved to another line on the display. Data is retained in the scratchpad throughout all mode and page changes.



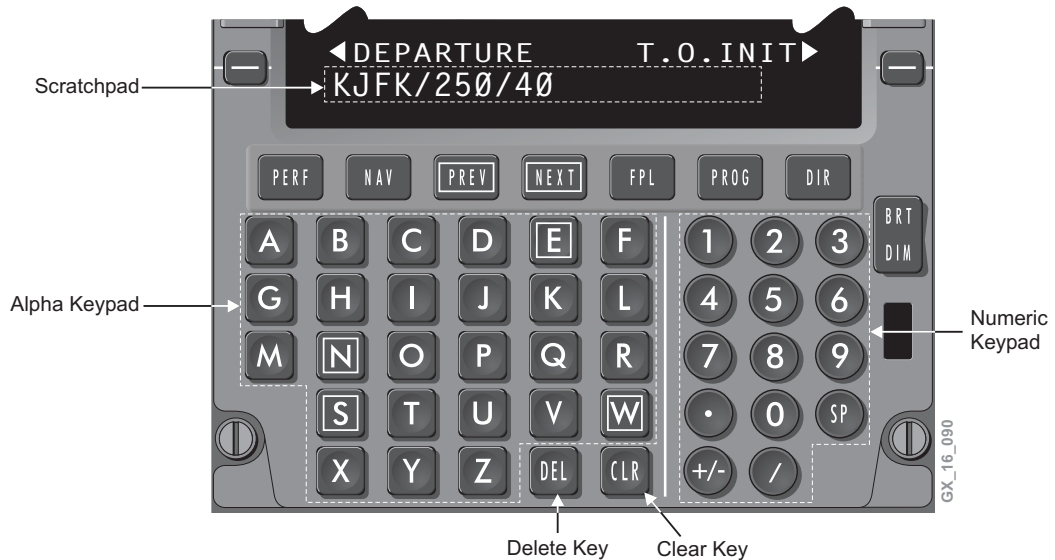

## Alphanumeric Keys

The alphanumeric keys are used to make entries into the scratchpad. The letters of the alphabet, the numbers 0 to 9, a decimal, a dash and a slash are each represented with a CDU key.

### Clear (CLR) Key

The CLR key has the following functions:

- When a message is displayed in the scratchpad, pushing the CLR key deletes the message
- Temporary waypoints are identified with an asterisk (\*) or pound sign (#) as the first character. When any entry beginning with an \* or a # is in the scratchpad, pushing the CLR key deletes the entire entry
- When an alphanumeric entry is made in the scratchpad, one character is cleared from the scratchpad (from right to left) each time the CLR key is pushed. If the CLR key is held down after the first character is cleared, other characters are cleared, one at a time, until the key is released



## Delete (DEL) Key

The DEL key is used to delete items from the FMS. When the DEL key is pushed, DELETE is displayed in the scratchpad. The DEL key can be line selected to delete waypoints or other items displayed in the CDU data fields. When there is a message displayed, the delete function is inhibited. DEL is also used to return default values after entries have been made. The DEL key may also be used to clear an entire alphanumeric entry in the scratchpad by selecting "-" followed by DEL.

## NAV DATA BASE VERIFICATION

On initial power up the FMS will display the NAV IDENT page. Verification of all data is essential to accurate FMS operation.

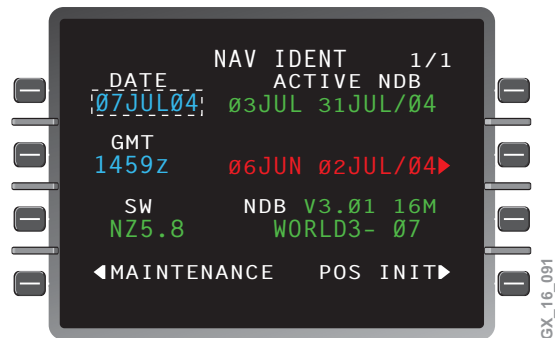

**Pos Init**

To select POS INIT, press 4R.

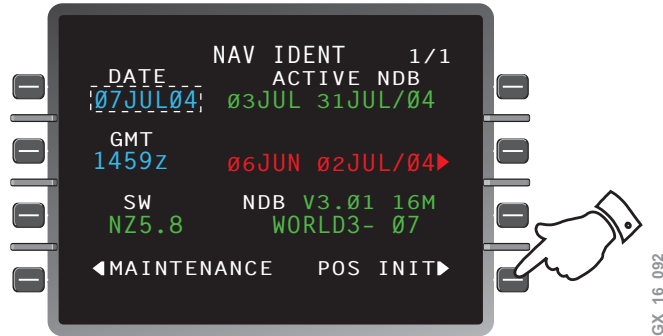

The POSITION INIT page displays the LAST POS coordinates and the closest ramp within 3 NM or closest airport reference point (KCIT) within 3 NM of the last position.

To initialize position, select appropriate LOAD prompt.

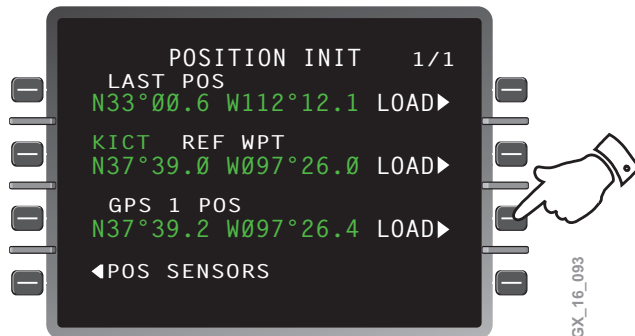

After initialization, the FLT PLAN prompt is displayed. Select 4R to continue pre-flight.

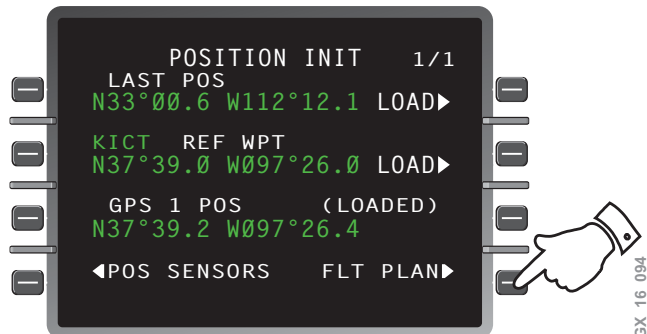

## Flight Plan

To select FLT PLAN, press 4R.

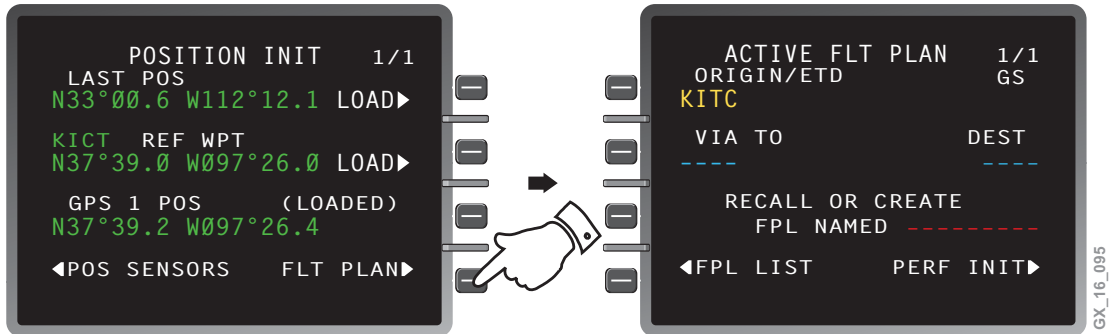

Enter destination (KORL) in the scratchpad and press 2R.

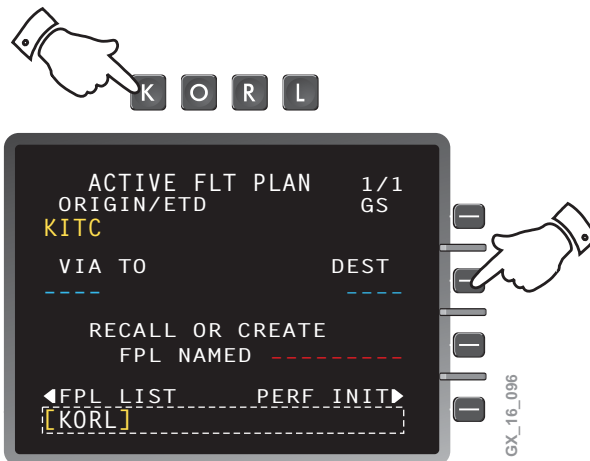

When a destination is entered, the FMS searches for stored flight plans with the same origin and destination. If any flight plans are found, the FLIGHT PLAN LIST page is displayed.

## FLIGHT PLAN (STORED)

Press 2L to bring KICT – KORL in scratchpad. Then press 1L to show the stored FLT PLAN.

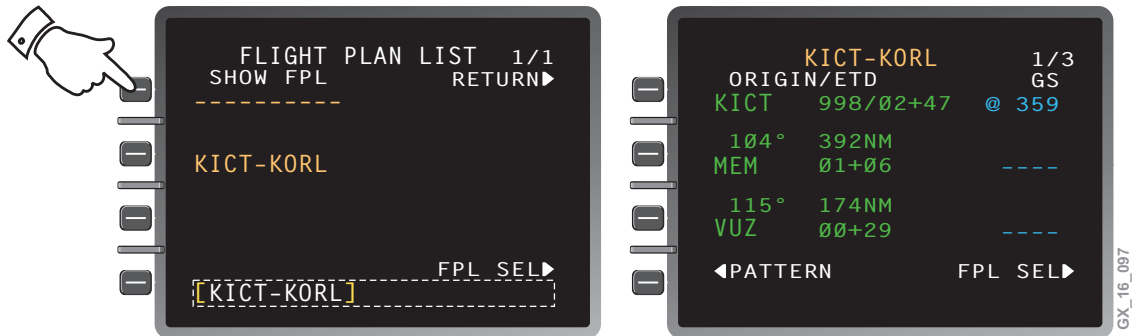

Review the flight plan and if satisfied, press 4R to select it.

**FLIGHT PLAN MANUAL WAYPOINT ENTRY**

Enter the waypoints and/or airways in the scratchpad and press 2L.

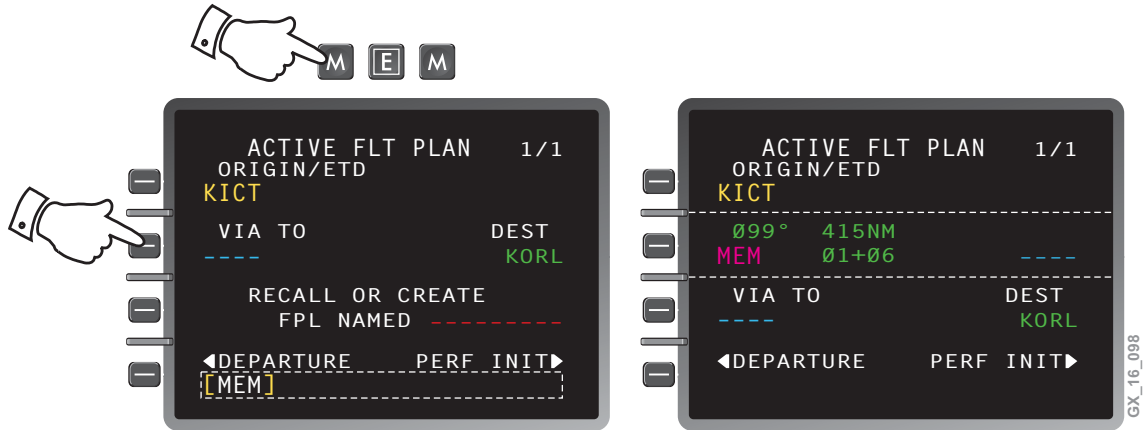

Enter the waypoints and/or airways in the scratchpad and press 3L.

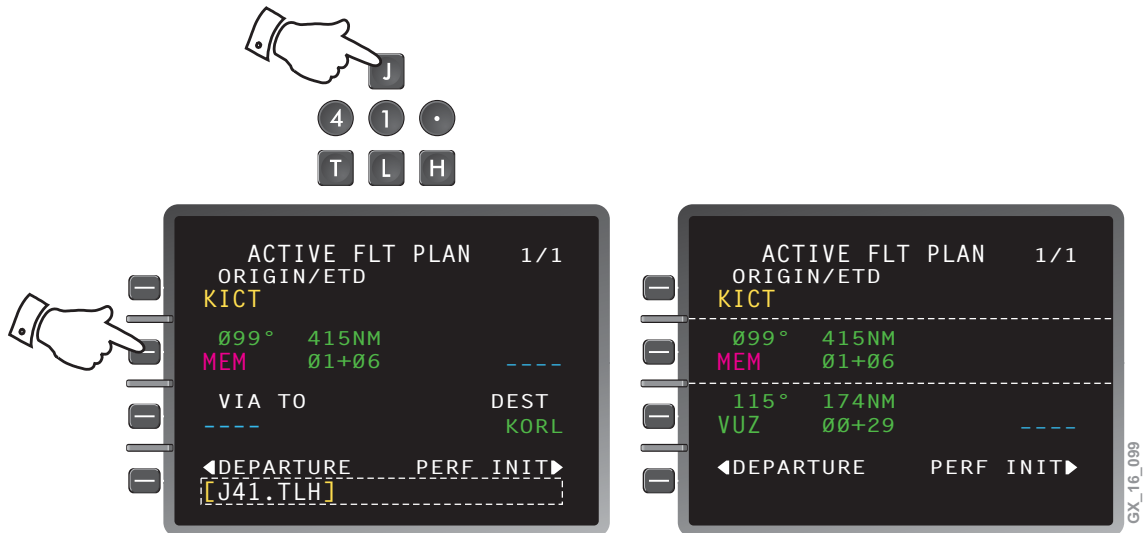

Once all the flight plan waypoints and/or airways have been entered, the flight plan is “closed out” by inserting the destination as the last VIA-TO waypoint.



## Departures

To select departure runway, and takeoff information:

Press 4L to display DEPARTURE RUNWAYS page.

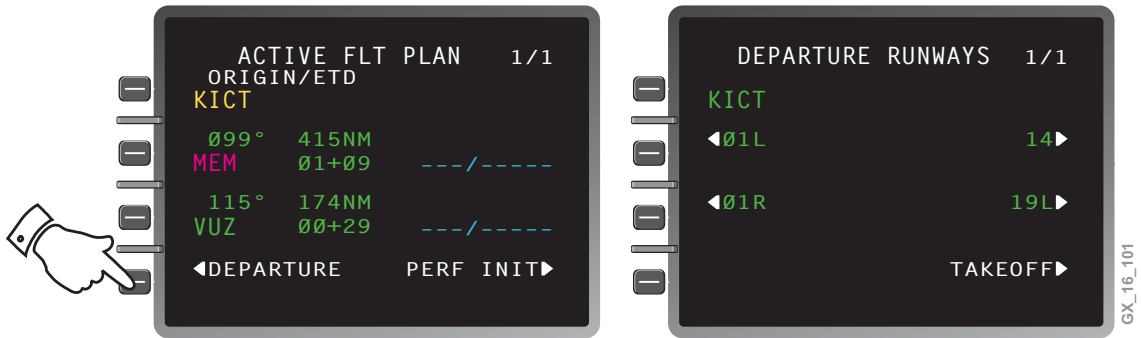

Select appropriate runway and FMS will return you flight plan page 1.

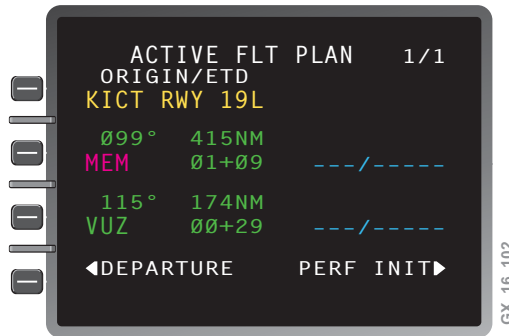

### Performance Initialization

The following are examples of the information that can be found on the PERF INIT pages. All pilot entries will appear in cyan. When all performance information has been entered press 4R on page 5/5 of PERFORMANCE INIT.

**Note:**

GEX005V2 = 96,000 lb Global  
 GEX006V2 = 98,000 lb Global  
 G5000-LI = G5000

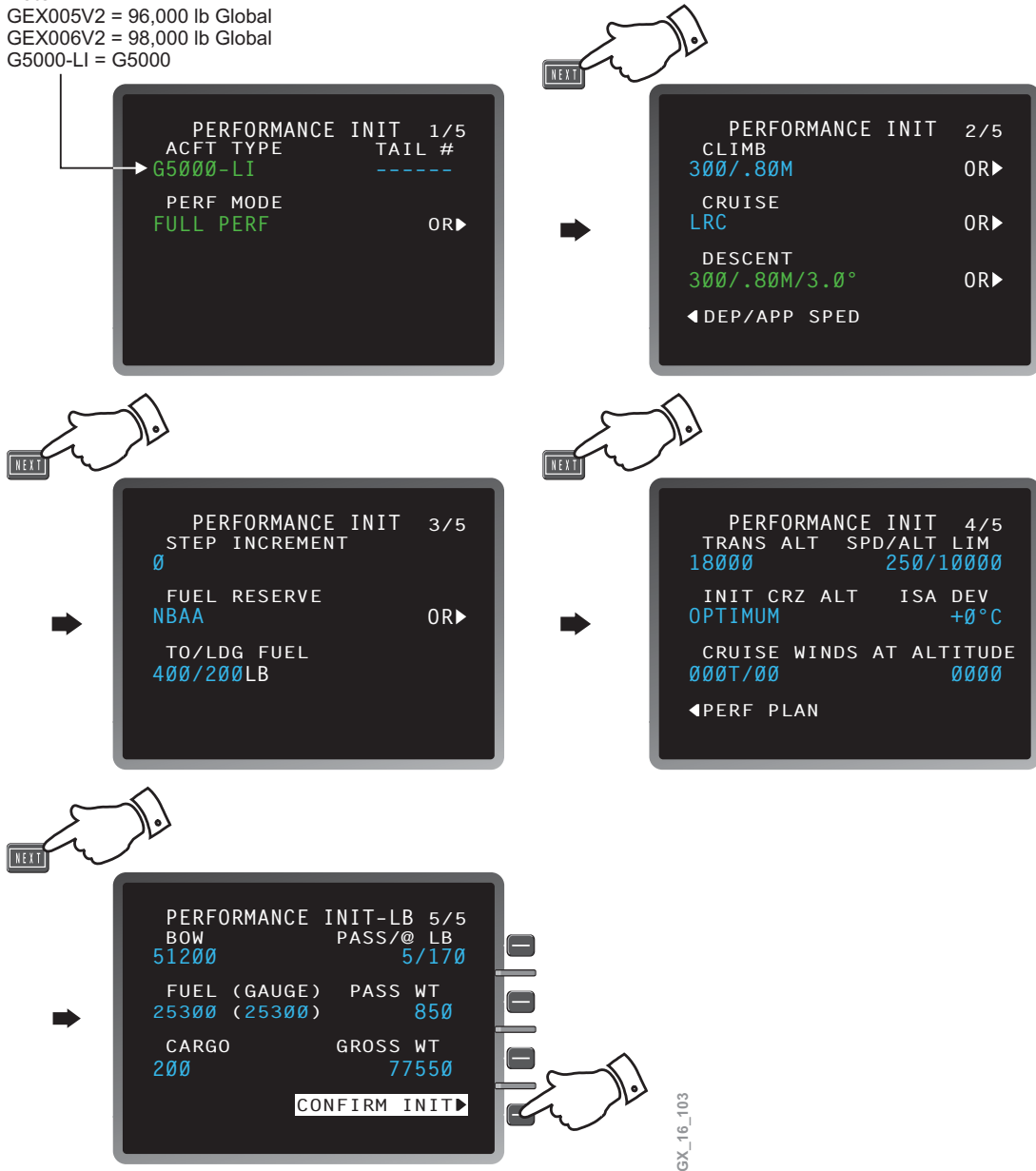

**NOTE**

For more information, refer to the Flight Management System Pilot's Guide.



NAVIGATION SYSTEM EICAS MESSAGES

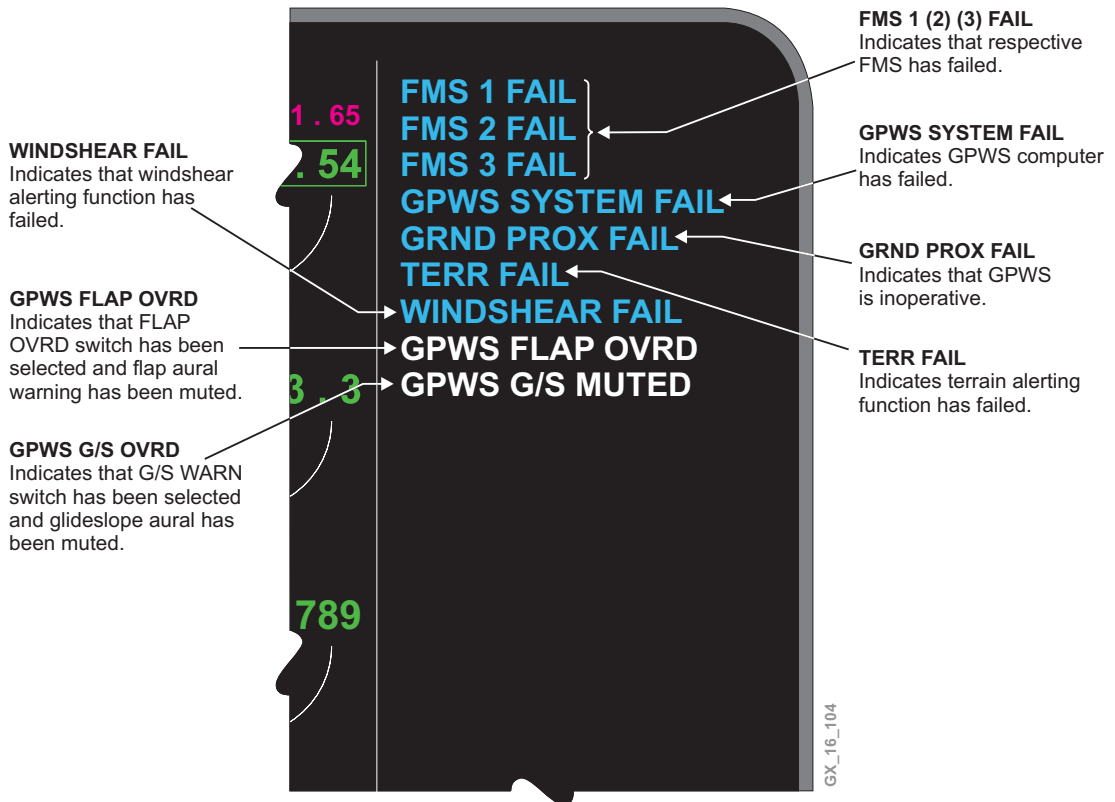

EMS CIRCUIT PROTECTION

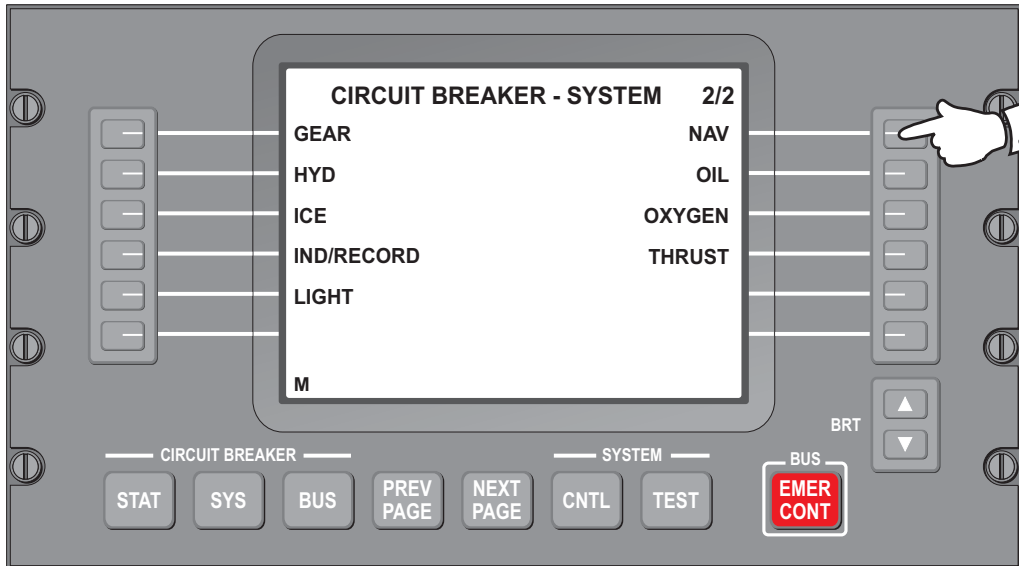

|   |  |  |  |  |  |
|---|--|--|--|--|--|
| <p><b>CB - NAV SYSTEM 1/6</b></p> <p>ADF 1 DC 1 IN</p> <p>ADF 2 DC ESS IN</p> <p>DME 1 DC 2 IN</p> <p>DME 2 DC ESS IN</p> <p>FMS 1 CDU BATT IN</p> <p>FMS 2 CDU DC 2 IN</p>                           |  |  | <p><b>CB - NAV SYSTEM 4/6</b></p> <p>IRS 3 FAN DC 1 IN</p> <p>IRS 3 PWR A DC 1 IN</p> <p>IRS 3 PWR B DC ESS IN</p> <p>LIGHTNING SENSOR DC 1 IN</p> <p>MFD 1 CTLR BATT IN</p> <p>MFD 2 CTLR DC 2 IN</p>         |  |  |
| <p><b>CB - NAV SYSTEM 2/6</b></p> <p>FMS 3 CDU DC 1 IN</p> <p>GPS 1 DC 1 IN</p> <p>GPS 2 DC 2 IN</p> <p>GPWS DC 1 IN</p> <p>HUD DC 2 IN</p> <p>HUD CTL PANEL DC 2 IN</p>                              |  |  | <p><b>CB - NAV SYSTEM 5/6</b></p> <p>RAD ALT 1 DC 1 IN</p> <p>RAD ALT 2 DC 2 IN</p> <p>STBY ADI AV BATT DIR CCBP IN</p> <p>STBY ALT/ASI AV BATT DIR CCBP IN</p> <p>TCAS DC ESS IN</p> <p>VOR/ILS 1 DC 2 IN</p> |  |  |
| <p><b>CB - NAV SYSTEM 3/6</b></p> <p>IRS 1 FAN DC ESS IN</p> <p>IRS 1 PWR A DC ESS IN</p> <p>IRS 1 PWR B BATT IN</p> <p>IRS 2 FAN DC 2 IN</p> <p>IRS 2 PWR A DC 2 IN</p> <p>IRS 2 PWR B DC ESS IN</p> |  |  | <p><b>CB - NAV SYSTEM 6/6</b></p> <p>VOR/ILS 2 DC ESS IN</p> <p>VOR/ILS 3 DC 1 IN</p> <p>WX RADAR DC 1 IN</p> <p>WX RADAR CTLR 1 DC 1 IN</p> <p>WX RADAR CTLR 2 DC 1 IN</p>                                    |  |  |
| M   |  |  | M  |  |  |

GX\_16\_105