

EMBRAER 135/145



Pneumatic Air Conditioning - Pressurization

GENERAL

The pneumatic system can be supplied by the engines, APU or a ground pneumatic source.

The APU or ground pneumatic source supplies the system prior to the engine start. The engines normally supply bleed air for pneumatics after engine start.

The air conditioning system receives air from the pneumatic system and provides conditioned air to the cabin. The system is controlled by two Environmental Control Units (ECU).

The pressurization system uses bleed air from the air conditioning system to pressurize the airplane. Cabin pressure is controlled by modulating the outflow valves. The system is controlled by an automatic mode and has a manual back-up mode.

Cooling for rear and forward electronic compartments is provided by the ventilation system.

System information and messages are presented on the EICAS.

PNEUMATIC SYSTEM

The pneumatic system receives compressed and hot air from the following sources:

- Engines compression stage
- APU
- Ground pneumatic source

The pneumatic system is used for: engine start, air conditioning, pressurization and anti-ice system.

Engine bleed air comes from the 9th (low pressure) or 14th (high pressure) engine stages depending on the system demand.

The 14th stage High Stage Valve (HSV), which is electrically commanded and pneumatically-actuated, opens automatically during low engine thrust operations, engine cross bleed start and anti-ice operation.

As thrust increases, the HSV closes and the 9th BACV (Bleed Air Check Valve) opens supplying bleed air to the system.

Bleed air for engine anti-ice system is provided through the tapping upstream of the HSV.

An Engine Bleed Valve (EBV), which is electrically commanded through the Bleed Air Button and pneumatically-actuated, is installed downstream of the pre-cooler.

Bleed air for the Air Turbine Starter (refer to Section 2-10 - Powerplant) is provided through the tapping downstream of the EBV.

Each engine supplies air to its corresponding air conditioning pack and anti-ice system when the respective EBV is open.

During take-off in specific thrust modes using engine bleed air, the operative air conditioning pack is closed by FADEC's ECS-OFF logic signal, featuring no engine bleed airflow demand when operating under no icing condition.

With no engine bleed air demand and high engine's thrust set, for airplanes Post-Mod. SB 145-36-0028 or equipped with an equivalent modification factory incorporated, EBV regulates its downstream pressure in the vicinities of its closed position and then BLD 1-2 VLV CLSD EICAS advisory message may be displayed for airplanes equipped with EICAS version 19 and on.

In case of icing encounter during no bleed airflow demand, for airplanes Pre-Mod SB 145-36-0028 EBV remains open and for airplanes Post-Mod SB 145-36-0028 or equipped with an equivalent modification factory incorporated, EBV is opened by the pneumatic system's functional logic to allow engine bleed airflow to anti-ice system.

A Cross-Bleed Valve (CBV), which is electrically commanded through the Cross Bleed Knob and pneumatically actuated, provides the segregation or interconnection between both sides in case of APU operation or one engine pneumatic supply.

The pneumatic system's functional logic opens or closes automatically the CBV, if the Cross Bleed Knob is on AUTO position, during engine start, depending on the available pneumatic source: APU, ground pneumatic source or opposite engine.

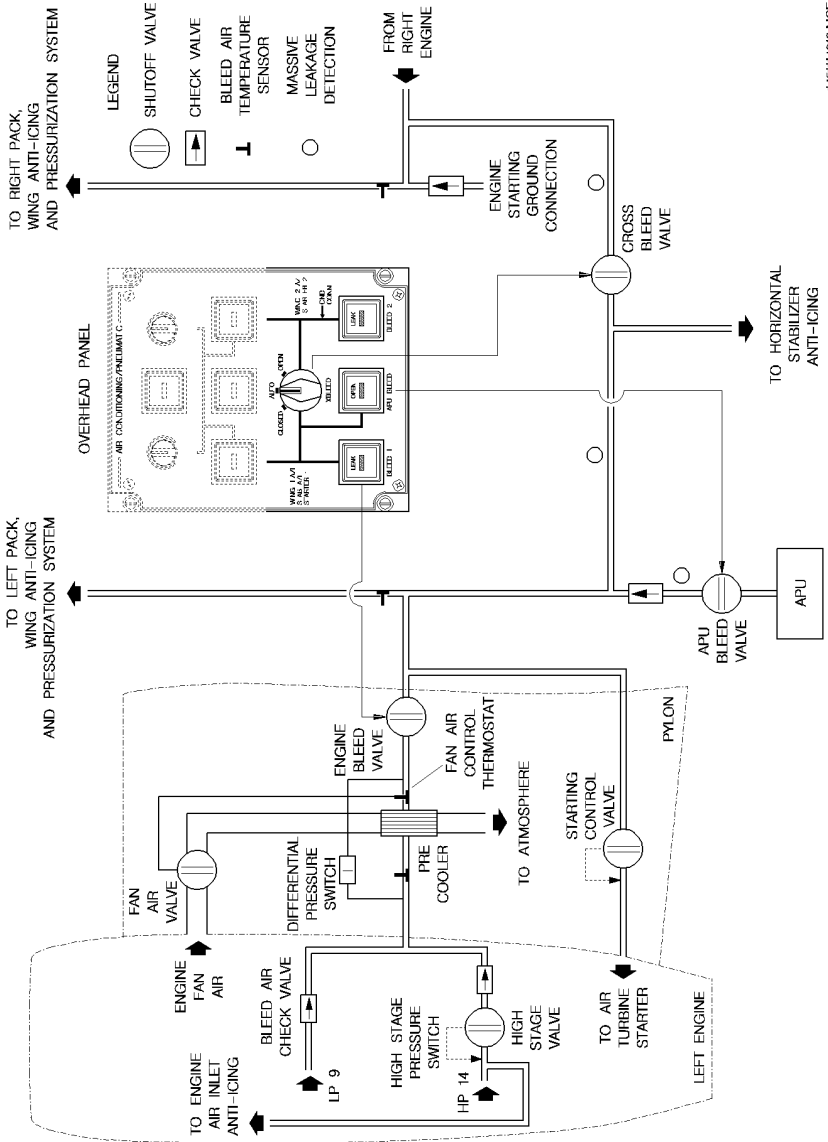

PNEUMATIC SYSTEM SCHEMATIC

The functional logic opens automatically the CBV and both HSVs and closes the left air conditioning pack below 24600 ft, whenever the anti-icing system is operating, on airplanes Pre-Mod. SB 145-36-0028.

On airplanes equipped with a pressure regulating and shutoff EBVs (Post-Mod. SB 145-36-0028), the functional logic also opens both HSVs and closes one pack below 24600 ft, but does not open the CBV if the anti-icing system is operating.

	Air Conditioning "On"	Ice Protection "On"
Airplanes Pre-Mod. SB 145-36-0028	Cross-bleed Closed	Cross-bleed Open
Airplanes Post-Mod. SB 145-36-0028 or equipped with an equivalent modification factory incorporated.	Cross-bleed Closed	

Bleed air from the APU, that is used primarily as an auxiliary pneumatic source, is provided in the left side of the pneumatic system to supply the air conditioning and engine starting either on ground or inflight.

An APU Bleed Valve (ABV), which is electrically controlled through the APU Bleed Button and pneumatically-actuated, provides APU bleed control.

The pneumatic system functional logic automatically closes the ABV whenever any engine is supplying bleed air to the left pneumatic side.

An APU Check Valve is installed downstream of the APU bleed valve.

A ground pneumatic source connection, including a check valve, is installed on the right side of the pneumatic system. Its main purpose is to supply pressurized air to start the engines.

Leak detectors (thermal switches) are installed along all the pneumatic lines. Should a duct leakage occur, these detectors activate a warning message in the EICAS.

Should an intense hot air leakage occur three Massive Leakage Detectors (thermal switches – formerly located at the pre-cooler and currently located in the rear electronic compartment area) will close the EBV of the affected side, as well as the CBV.

Bleed temperatures upstream and downstream of the pre-cooler are monitored through temperature sensors. Temperature downstream of the pre-cooler is presented on a vertical bar indication on the MFD.

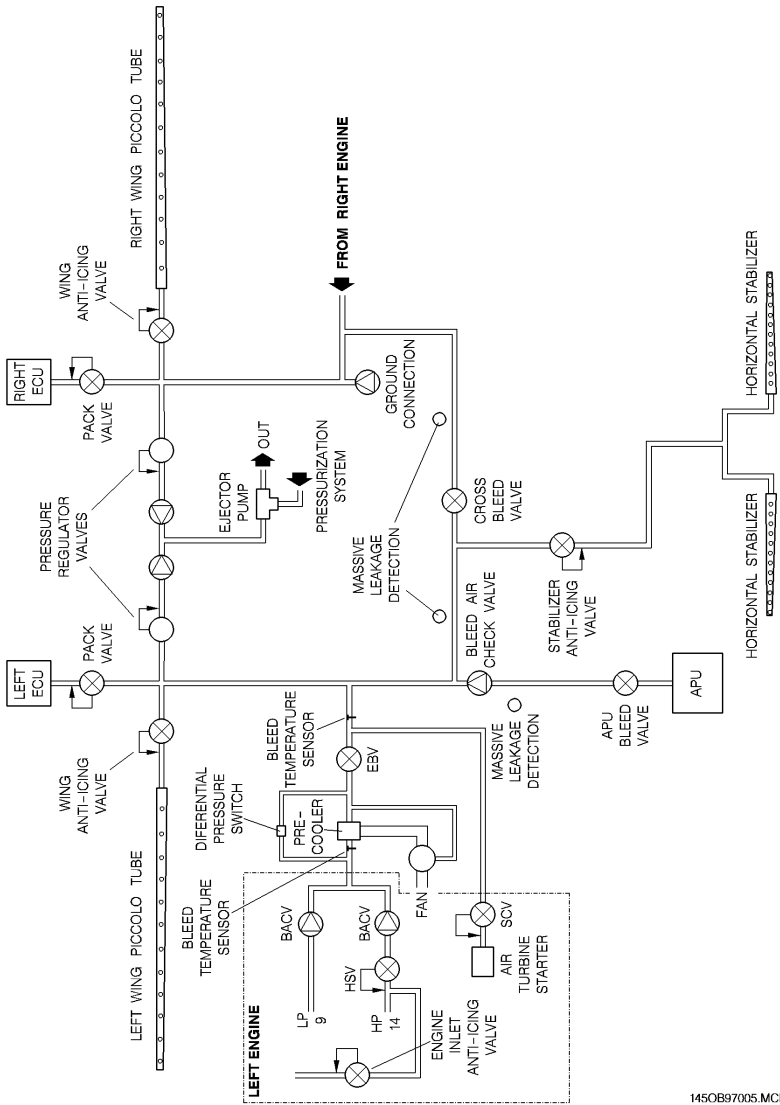

1450B97005.MCE

INTEGRATED PNEUMATIC SYSTEM SCHEMATIC

PNEUMATIC SYSTEM FUNCTIONAL LOGIC

The pneumatic system functional logic provides automatic control and protection for itself and the user systems, giving priority according to the airplane operation or condition.

ENGINE BLEED VALVE LOGIC

The Engine Bleed Valve (EBV) opens when the following conditions occur simultaneously:

- Bleed Air Button is pressed to open the valve;
- Respective Essential Bus is energized;
- There is no massive leakage on the respective side of the rear electronic compartment;
- There is no leakage downstream of the respective pre-cooler;
- Respective engine N2 is above 56.4%; and
- Respective engine fire extinguishing handle is not pulled.
- Bleed is requested by one of the bleed consuming systems (airplanes Post-Mod. SB 145-36-0028).

APU BLEED VALVE OPERATIONAL LOGIC

The APU Bleed Valve (ABV) receives an electrical input to open when the following conditions occur simultaneously:

- APU Bleed Button is pressed to open the valve;
- Essential DC Bus 1 is energized;
- Engine 1 bleed valve is closed (no pressure from the left side);
- Engine 2 bleed valve or cross-bleed valve is closed (no pressure from the right side);
- APU rpm above 95% after 7 seconds; and
- There is no massive leakage on the APU line.

CROSS BLEED VALVE OPERATIONAL LOGIC

The Cross-Bleed Valve (CBV) receives an electrical input to open when the following conditions occur:

- Essential DC Bus 2 is energized;
- There is no massive bleed leakage downstream of the pre-cooler or in the Rear Electronic Compartment; and
- Cross Bleed Knob is set to OPEN; or
- Cross Bleed Knob is set to AUTO and one of the following conditions occurs:
 - Engine 2 is starting; or
 - Engine 1 is starting assisted by engine 2 or external pneumatic source (with APU Bleed Valve manually commanded to the close position); or
 - The Horizontal Stabilizer Anti-Icing System is operating (airplanes Pre-Mod. SB 145-36-0028).

EICAS MESSAGES

TYPE	MESSAGE	MEANING
WARNING	BLD 1 (2) LEAK BLD APU LEAK	Duct leakage in the associated bleed line. Temperature in the duct region exceeds 91°C (195°F). The switch deactivates at 79°C (175°F).
	BLD 1 (2) OVTEMP	Associated pre-cooler downstream temperature above 305°C (581°F).
CAUTION	APU BLD VLV FAIL	Disagreement between actual position and commanded position of the APU Bleed Valve.
	BLD 1 (2) LOW TEMP	Abnormal low or asymmetric bleed temperature, or pre-cooler outlet temperature sensor failure.
	BLD 1 (2) VLV FAIL	Disagreement between actual position and commanded position of the associated Engine Bleed Valve.
	CROSS BLD FAIL	Disagreement between actual position and commanded position of the Cross-Bleed Valve.
	CROSS BLD SW OFF	Cross Bleed Knob selected CLOSED with at least one engine running after brake release.
	HS VLV 1 (2) FAIL	Disagreement between actual position and commanded position of the associated High Stage Valve.
ADVISORY	BLD 1 (2) VLV CLSD	Associated Engine Bleed Valve position. This message is inhibited on ground or during associated engine start.
	CROSS BLD OPEN	Cross Bleed Valve open.

AIR CONDITIONING SYSTEM

Airplane air conditioning is provided by two the Environmental Control Units (ECU) supplied by the Pneumatic System.

Each side is provided with independent controls, protection devices, and cross-connected air distribution lines for the various modes of operation.

Cockpit and passenger cabin temperature selections are independent and may be controlled either manually or automatically. The left ECU controls the temperature in the cockpit and the right ECU controls the temperature passenger cabin.

The system is normally operated in the automatic mode. In case of automatic mode failure, a manual mode is available.

The pilots may transfer the passenger cabin temperature control to the Attendant Panel.

The air conditioning distribution is performed by the gasper system and general outlets with cross-connection between the cockpit and passenger cabin lines.

This feature, associated with the ram air inlets, allows the cockpit and passenger cabin to be supplied with fresh air, in case of failure of both ECUs.

Recirculating air, driven by two electrical fans, is mixed to fresh air in order to improve passenger and crewmembers' comfort.

A ground cart connection is available at the right-hand duct, connected to the outside through a check valve in the fuselage. The pre-conditioned air from the ground cart is delivered to the cabin directly through the distribution lines.

The air conditioning system incorporates protection features in the temperature controllers which shut off the system in case of malfunctions (duct leakage, duct overtemperature, and pack overtemperature).

The cockpit and passenger cabin temperature indications are presented on the MFD. Caution and advisory messages are presented on the EICAS.

ECU OPERATION

Each ECU consists of a dual heat exchanger, an air cycle machine (compressor, turbine, and fan), a condenser, a water separator and related control and protective devices, installed forward of the airplane wing root, inside the wing-to-fuselage fairing.

The automatically-controlled bleed air from the pneumatic system supplies the ECU. Downstream pressure is regulated by the Pack Valve (Pressure Regulating and Shutoff Valve).

After the Pack Valve, the airflow is divided into two lines:

- One cold line that passes through to the Air Cycle Machine.
- One hot line that bypasses the Air Cycle Machine.

Both airflow lines are gathered at the expansion turbine discharge.

In the Air Cycle Machine (ACM), air is cooled in the primary heat exchanger and passes through the compressor, thus causing a pressure increase. The air then goes to the secondary heat exchanger where it is cooled again.

After leaving the secondary heat exchanger, the high-pressure cooled air passes through a condenser and a water separator for condensed water removal. Spray nozzles use the separated water to improve the heat exchanger efficiency.

The main airstream is ducted to the turbine and expanded to provide power for the compressor and cooling fan. This energy removal produces very low turbine discharge temperatures, achieving adequate low temperatures in the process.

The cold exit air is mixed with warm air supplied by the recirculation fan and/or with the hot bypass air immediately upon leaving the turbine. A check valve is provided in the recirculation duct to prevent reverse flow if the recirculation fan is inoperative.

The ECU outlet air temperature is controlled through the dual temperature control valve. One valve adds hot bleed air to the turbine discharge while the other valve restricts the compressor inlet flow.

The ECUs are cooled in flight by external the ACM fans, using the external ram air. On the ground, the ECUs are cooled by the ACM fans only.

The system has emergency ventilation, as an alternate means to allow the outside air into the cabin. The impact air passes through the same ram air inlets that are used to cool the dual heat exchangers.

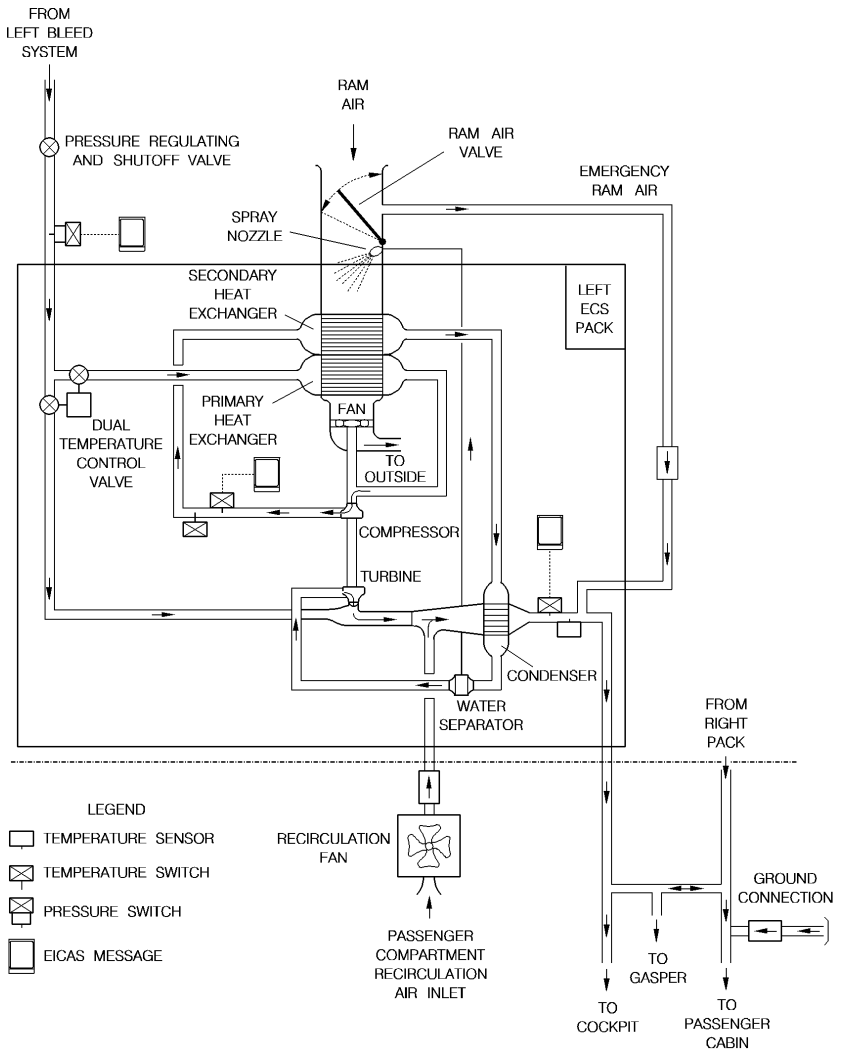

1451114058.MCE

AIR CONDITIONING SYSTEM SCHEMATIC

When the ECUs air supply is shut off in flight, the emergency ram air is activated and the ram air valves are opened automatically, allowing ram air to be routed to the distribution lines. Ram air may also be used to ventilate the airplane interior for cabin smoke evacuation and cabin ventilation purposes with the airplane depressurized and the ECUs turned off.

NOTE: The Pneumatic System automatic logic closes the left Pack Valve whenever the anti-icing system is operating below 24600 ft.

CABIN TEMPERATURE CONTROL

AUTO MODE

In the automatic mode (temperature knobs pressed), the temperatures in the passenger cabin and in the cockpit are controlled by the digital temperature controllers that receive information from the temperature sensors (ducts, passenger cabin, or cockpit), maintaining the temperature set on the associated temperature knob.

MANUAL MODE

In manual mode (temperature knobs pulled), the temperature in the passenger cabin and in the cockpit are controlled by the temperature control module, that receives information from the temperature knobs and the duct temperature sensor.

The manual mode should be used only if a failure occurs in the automatic mode and may be noticed when the temperature is not maintained within the temperature limits of the automatic mode (between 18 and 29°C) after cabin temperature stabilization.

If switching from auto mode to manual mode is required, proceed as follows:

- Set the knob to mid range position (12 o'clock).
- Wait for system to stabilize (approximately 30 seconds).
- Switch to manual.
- Smoothly turn the knob to the required point.

Once in the manual mode, the pilot must continuously monitor the temperature and actuate on the Temperature and Mode Selector Knob.

NOTE: On airplanes Pre-Mod. SB 145-21-0011, for cruise flight times of 1:30 h or longer, it is recommended that the passenger cabin temperature be controlled by using the manual mode.

AIR CONDITIONING DISTRIBUTION

The air conditioning distribution system provides conditioned air to the cockpit and passenger cabin.

The main source of conditioned air to the cockpit is the left pack, with a single distribution system for cooling or heating air.

The cockpit is provided with two FEET AIR handles and air outlets, allowing each pilot to individually control the airflow.

For CRT displays ventilation, a shutoff valve on each side, electrically-driven and independently controlled by a thermal switch, allows cold air to be supplied for this function only.

The main source of conditioned air to the passenger cabin is the right pack and partially by the left pack, through a cross connection duct.

The air distribution system for the passenger cabin is divided into three lines. One line is distributed to the lower ducts, installed at the foot level on both cabin sidewalls. The second line is for the upper ducts of both sidewalls. The third line is dedicated to the gasper. If the duct temperature is below 24°C (75°F), the associated temperature switches command the recirculation fans to increase airflow.

The gasper air subsystem provides air to individual air outlets (gasper), as well as for the rear electronic compartment, oxygen cylinder compartment and relay box ventilation. The air to the gasper is provided by a gasper fan and by one branch from the cross connection of the general distribution system. The gasper fan is similar to the recirculation fan, but it is operated in normal condition only. One thermal switch is installed in the branch line to close fresh air in case of heating condition (above 24°C). In this case, only air from the gasper fan is available.

The recirculation air subsystem, consists of two recirculation fans, and is usually operated to save the engine bleed. It must be kept off should there be smoke in the cabin, or on hot days while on the ground. This reduces the pull-down period and should be turned on in cold soak conditions to reduce pull-up period.

The operational logic to open the Engine Bleed, Cross-bleed, APU Bleed, and Pack Valves will be analyzed herein separately, for better system comprehension. This system also actuates on the Anti-icing System Valves. For further information, refer to Section 2-15 - Ice and Rain Protection.

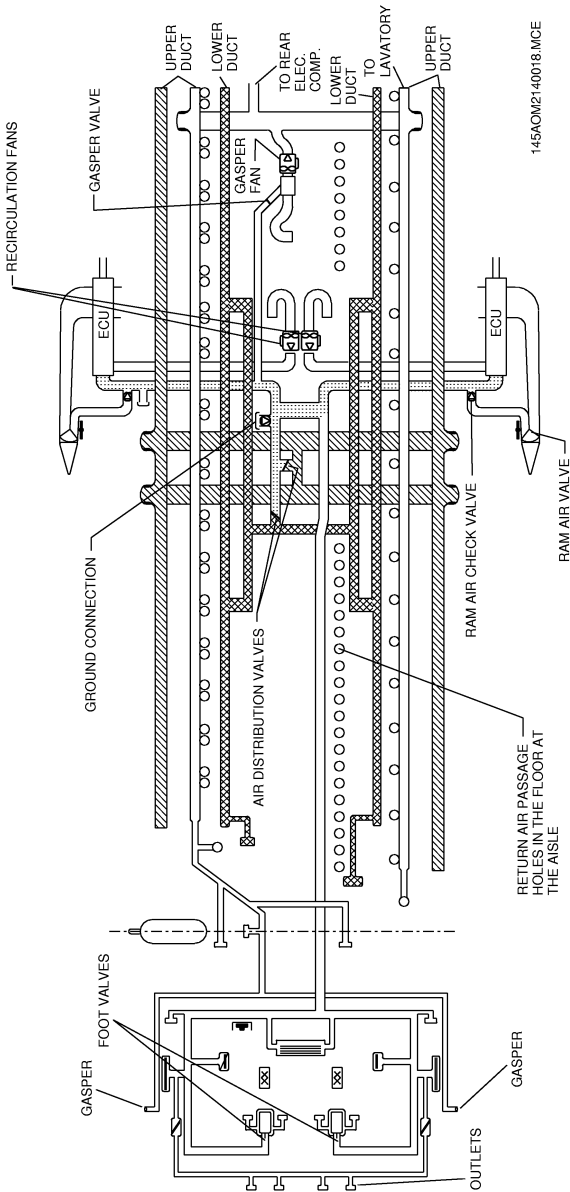

AIR CONDITIONING SYSTEM DISTRIBUTION

PACK VALVE OPERATIONAL LOGIC

The Pack Valve receives an electrical input to open when the following conditions occur simultaneously:

- Air Conditioning Pack Button is pressed to open the valve;
- Respective DC Bus is energized;
- Respective engine is not starting;
- No engine is starting using the APU as pneumatic source;
- No failure in the related pack is detected (overpressure, overtemperature or duct leakage downstream of the Pack Valve); and
- No discrete ECS (Environmental Control System) OFF signal is sent from any related FADEC (A or B).

The FADEC's discrete ECS OFF signals are produced according to the following conditions:

1- During Takeoff or Go Around:

ACTIVATION CONDITIONS FOR ECS OFF SIGNALS				
ENGINE	FADEC	MODE	PRESSURE ALTITUDE / TAT °C	
			ALL ENGINES OPERATIVE (takeoff only)	ONE ENGINE INOPERATIVE (5)
A or A1/1	ALL	T/O-1	Up to 1700 ft above takeoff altitude and TAT above -18°C (-0.4°F)	Lower than 9700 ft (2)
A1 or A3	ALL	T/O-1	Up to 1700 ft above takeoff altitude (3)	Lower than 9700 ft (4)
A1/3 or A1P	ALL	T/O-1, T/O or T/O RSV	Up to 1700 ft above takeoff altitude (3)	Lower than 9700 ft (4)
A1E	ALL	T/O-1, T/O, E T/O, T/O RSV or E T/O RSV	Up to 1700 ft above takeoff altitude (3)	Lower than 9700 ft (4)

- NOTE:**
- 1) The ECS OFF signal is activated for the pack associated with the operating engine if the pressure altitude is lower than 15000 ft and TAT is above -18°C (areas A, B and C in the following envelope).
 - 2) The ECS OFF signal is activated for the pack associated with the operating engine if the pressure altitude is lower than 9700 ft and TAT is above -18°C (areas B and C in the following envelope).
 - 3) TAT above 19°C (66°F) at sea level, decreasing linearly to -5°C (23°F) at 9700 ft.
 - 4) The ECS OFF signal is activated for the Pack associated with the operating engine if the pressure altitude is lower than 9700 ft and TAT is above 19°C at sea level, decreasing linearly to -5°C at 9700 ft (area B in the following envelope).
 - 5) A Low N1 condition (actual N1 does not achieve requested N1) is considered one engine inoperative.

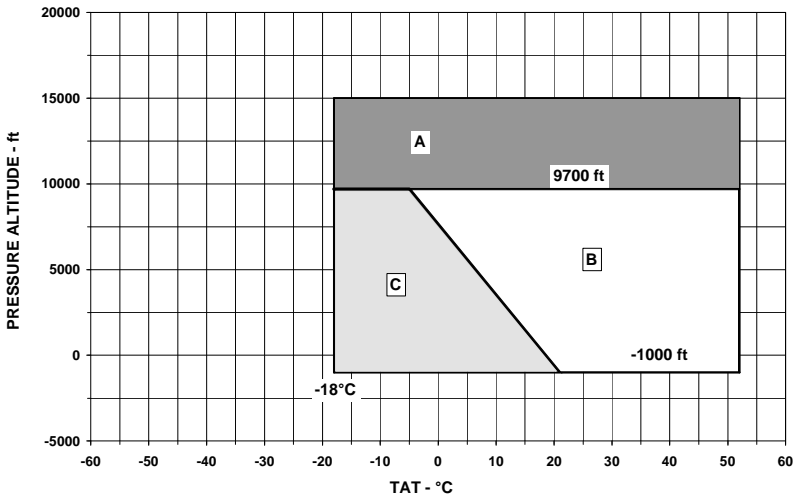

FADEC'S ECS OFF ENVELOPE

The ECS OFF logic is valid only when the packs are using engine bleed. If APU bleed is being used, the ECS OFF logic is inhibited and the pack valves will not shut down.

The FADEC's discrete ECS OFF signal is not produced when using ALT T/O-1 mode during takeoffs with all engines operative.

On all EMB-145 XR models, packs are automatically reset when the conditions for the ECS OFF signal cease to exist. When both packs are automatically reset, pack 2 will be commanded to open 10 seconds after pack 1 opening, to avoid passenger discomfort due to packs return.

On other airplane models, if a FADEC commands its associated pack to close through the ECS OFF signal, the pilot must reset the pack when the conditions for the automatic shut down of the pack cease to exist, i.e., an automatic restart of the pack does not exist.

2- During reverse use:

The ECS OFF signal is not activated during reverse use.

EICAS MESSAGES

TYPE	MESSAGE	MEANING
CAUTION	PACK 1 (2) OVLD	Associated ECU compressor temperature above 243°C (470°F) or ECU inlet pressure above 55 psig.
	PACK 1 (2) OVHT	Associated ECU outlet temperature above 93°C (200°F).
	PACK 1 (2) VLV FAIL RAM AIR VLV FAIL	Disagreement between associated valve actual position and commanded position.
ADVISORY	PACK 1 VLV CLSD	Left pack valve closed with no icing condition, or Left pack valve closed with airplane above 24600 ft.
	PACK 2 VLV CLSD	Right pack valve closed.

CONTROLS AND INDICATORS

AIR CONDITIONING AND PNEUMATIC CONTROL PANEL

1 - COCKPIT TEMPERATURE AND MODE SELECTOR KNOB

- PRESSED - Controls the left pack in automatic mode through the Digital Temperature Controller. The cockpit temperature may be set between 18°C (65°F) and 29°C (85°F).
- PULLED - Controls the left pack in manual mode through the temperature control module. No temperature range is established.

2 - PASSENGER CABIN TEMPERATURE AND MODE SELECTOR KNOB

- PRESSED - Controls the right pack in automatic mode through the Digital Temperature Controller. The passenger cabin temperature may be set between 18°C (65°F) and 29°C (85°F).
- PULLED - Controls the right pack in manual mode through the manual mode circuit in the temperature control module. No temperature range is established.
- ATTD - The passenger cabin temperature control is transferred to the attendant's panel in automatic mode only.

3 - RECIRCULATION BUTTON

- Turns on (pressed) or turns off (released) both recirculation fans.
- A striped bar illuminates inside the button to indicate that it is released.

4 - AIR CONDITIONING PACK BUTTON

- Opens (pressed) or closes (released) the Pressure Regulating and Shutoff Valve of the associated ECU.
- A striped bar illuminates inside the button to indicate that it is released.

5 - GASPER BUTTON

- Turns on (pressed) or turns off (released) the gasper fan in flight only.
- A striped bar illuminates inside the button to indicate that it is released.
- On ground, the gasper fan is turned on as soon as the associated DC Bus is energized.

6 - CROSS-BLEED KNOB

- CLOSED- Closes the Cross-bleed Valve.
- AUTO - Selects automatic operation mode of the Cross-bleed Valve.
- OPEN - Opens the Cross-bleed Valve.

7 - BLEED AIR BUTTON

- Opens (pressed) or closes (released) the associated Engine Bleed Valve.
- A striped bar illuminates inside the button to indicate that it is released.
- A LEAK inscription illuminates inside the button to indicate a duct leakage in the associated bleed line.
The LEAK inscription is not available on some airplanes.

8 - APU BLEED BUTTON

- Opens (pressed) or closes (released) the APU Bleed Valve.
- A striped bar illuminates inside the button to indicate that it is pressed.
- An OPEN inscription illuminates inside the button to indicate that the APU Bleed Valve is in the open position.

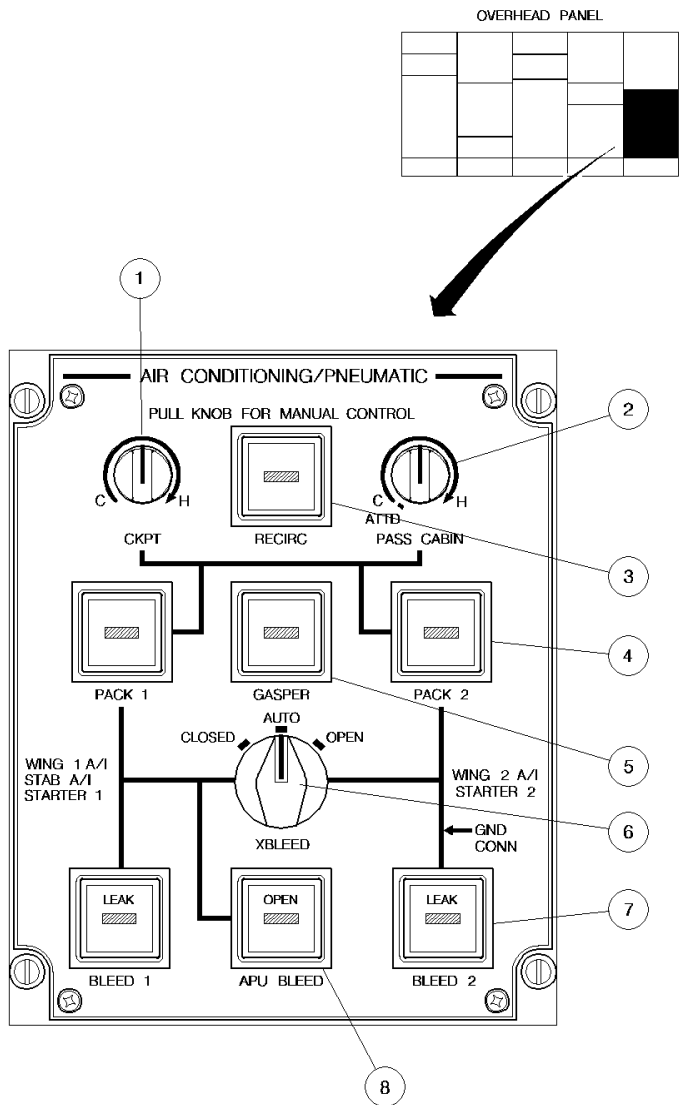

1461114053.MCE

AIR CONDITIONING AND PNEUMATIC CONTROL PANEL

ENVIRONMENTAL CONTROL SYSTEM (ECS) AND PNEUMATIC PAGE ON MFD

1 - PASSENGER CABIN TEMPERATURE INDICATION

- Indicates the temperature inside the passenger cabin.
- Digits are green.
- Legends are white.
- Ranges from -10 to 50°C (14 to 122°F).

2 - COCKPIT TEMPERATURE INDICATION

- Indicates the temperature inside the cockpit.
- Digits are green.
- Legends are white.
- Ranges from -10 to 50°C (14 to 122°F).

3 - BLEED TEMPERATURE INDICATION

- Indicates the bleed air temperature downstream of the pre-cooler on the left and right engine.
- Scale and Pointer:

- White for the scale, below 260°C (500°F) to indicate potentially low thermal energy availability to the anti-icing system. Amber for the pointer, only if the pointer is in the white band of the scale and the message “BLD 1 (2) LOW TEMP” is shown on EICAS.

If the pointer is in the white band of the scale and the message “BLD 1 (2) LOW TEMP” is not presented in the EICAS, the pointer will be green.

- Green from 260 to 305°C (500 to 581°F) to indicate the acceptable range.
- Red above 305°C (581°F) to indicate an overtemperature condition.
- In case of an outlet temperature sensor failure, the respective pointer is removed from the vertical temperature bar.

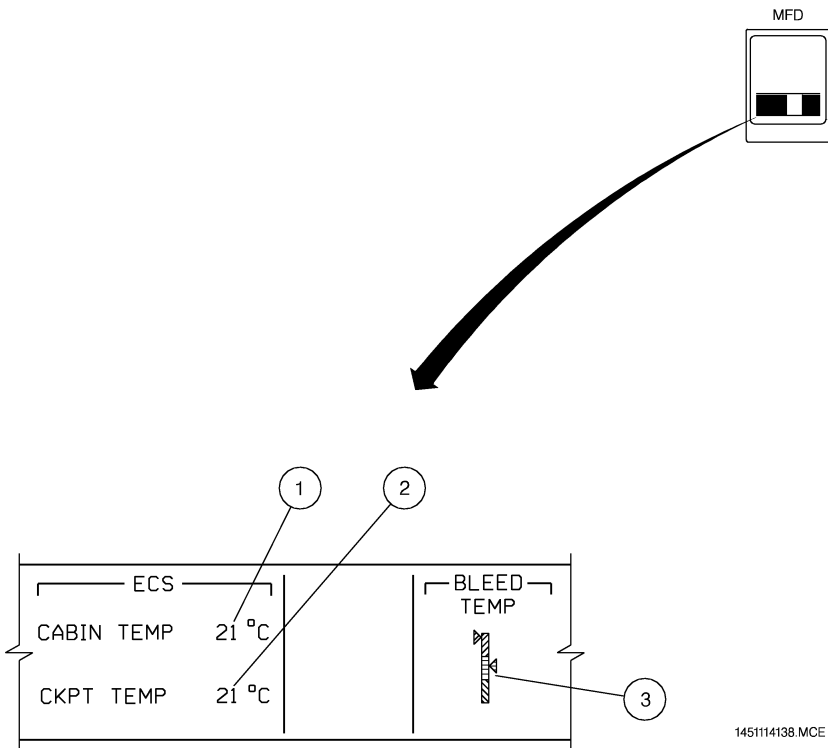

ENVIRONMENTAL CONTROL SYSTEM (ECS) AND PNEUMATIC PAGE ON MFD

ATTENDANT'S CONTROL PANEL

1 - ON INDICATOR LIGHT (green)

- Illuminates to indicate that the passenger cabin temperature control is transferred to the attendant's panel.

2 - PASSENGER CABIN TEMPERATURE CONTROL (knob or sliding control)

- Actuates on the passenger cabin temperature controller (right ECU) in the automatic mode, provided the Passenger Cabin Temperature and Mode Selector is set to the ATTD position.
- The attendant may set the passenger cabin to between 18°C (65°F) and 29°C (85°F).

ATTENDANT'S
CONTROL
PANEL

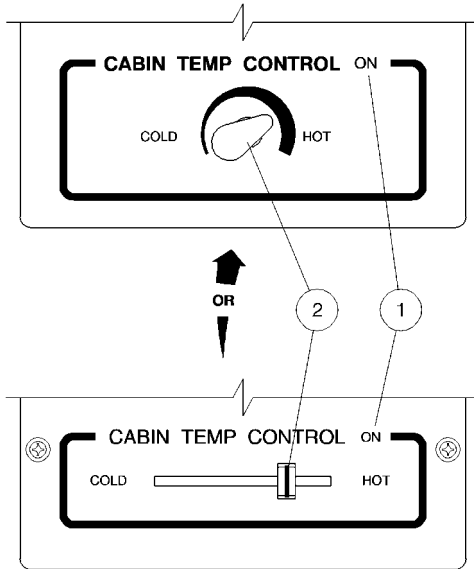
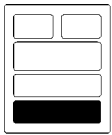

145AOM2140005.MCE

ATTENDANT'S CONTROL PANEL

PRESSURIZATION SYSTEM

The Cabin Pressure Control System (CPCS) controls the cabin pressure by regulating the cabin air exhaust rate supplied by the ECUs.

The CPCS comprises two subsystems:

- One digital electropneumatic subsystem(automatic mode).
- One pneumatic subsystem (manual mode).

Both subsystems comprise a digital controller, a manual controller, an electropneumatic outflow valve, a pneumatic outflow valve, an air filter, two pressure regulator valves, an ejector pump, two static ports, and a Cabin Pressure Acquisition Module (CPAM).

Both outflow valves receive static pressure signals from static ports for overpressure relief and negative pressure relief functions, actuating pneumatic devices to inhibit airplane structural damage or injury in case of improper system operation. The safety devices provide the following features:

- Positive cabin differential pressure relief: 8.2 psi maximum.
- Negative cabin differential pressure relief: - 0.3 psi.
- Cabin altitude limitation (when in the auto mode): 15000 ft maximum.

The system is normally operated in the automatic mode. The manual mode is used in case of automatic mode failure.

The cabin air filter is provided to prevent nicotine and dust to enter the outflow valve chamber.

Indications of cabin altitude, cabin differential pressure, and cabin altitude rate of change are presented on the EICAS.

A caution message is presented on the EICAS in case of automatic mode failure, requiring the crew to select the manual mode.

The CPAM and CPCS have internal tolerances of ± 100 ft and ± 200 ft, respectively. Then, depending on these tolerances accumulation, the displayed cabin altitude may be increased up to 300 ft. Although displayed in the amber range for airplanes equipped with EICAS version up to 16, it may not be considered an abnormal condition if cabin altitude indication remains stabilized at or below 8300 ft.

If, however, the cabin altitude indication continuously increases and the system is out of its normal range of operation, causing a cabin depressurization, the CPAM sends a signal to the aural warning system to alert the crew when cabin altitude is above 9900 ± 100 ft.

OPERATION IN AUTOMATIC MODE

The automatic mode maintains minimum cabin altitude according to the airplane operating altitude, imposing minimum cabin altitude rate of change.

The automatic mode is controlled by the digital controller and requires a landing altitude to be entered prior to takeoff. According to the landing altitude, the measured cabin pressure, ADC inputs (airplane altitude, altitude rate of change and barometric correction), air/ground position, and thrust lever position, the digital controller determines the adequate opening of the electropneumatic outflow valve. The pneumatic outflow valve is slaved to the electropneumatic outflow valve and both operate simultaneously, maintaining the same position while in the automatic mode

Different operation sequences are automatically initiated by the Digital Controller following the received inputs.

The Digital Controller schedules a cabin altitude that is the value that the measured cabin altitude must be equal to.

Cabin altitude rate of change varies according to the different operation sequences.

Proper operation of the pressurization system in the automatic mode requires that the following conditions be met:

- Automatic mode is selected on the Digital Controller (button not pressed and MAN inscription not illuminated). The pressurization system is in the automatic mode when electrical power is first applied.
- Landing altitude is entered in the Digital Controller prior to the takeoff. Should the landing altitude not be entered, the system will automatically consider 8000 ft as the landing altitude.
- Manual Controller is set to DN position (full counterclockwise). If the Manual Controller is out of the DN position, the pneumatic valve tends to open causing inappropriate automatic mode operation.

DETERMINATION OF THE THEORETICAL CABIN ALTITUDE

The theoretical cabin altitude is a function of the airplane operating altitude. It is calculated in such a way that the maximum cabin differential pressure (7.8 psi) is reached at the lowest possible airplane altitude considering a minimum cabin altitude rate of climb and a maximum airplane rate of climb.

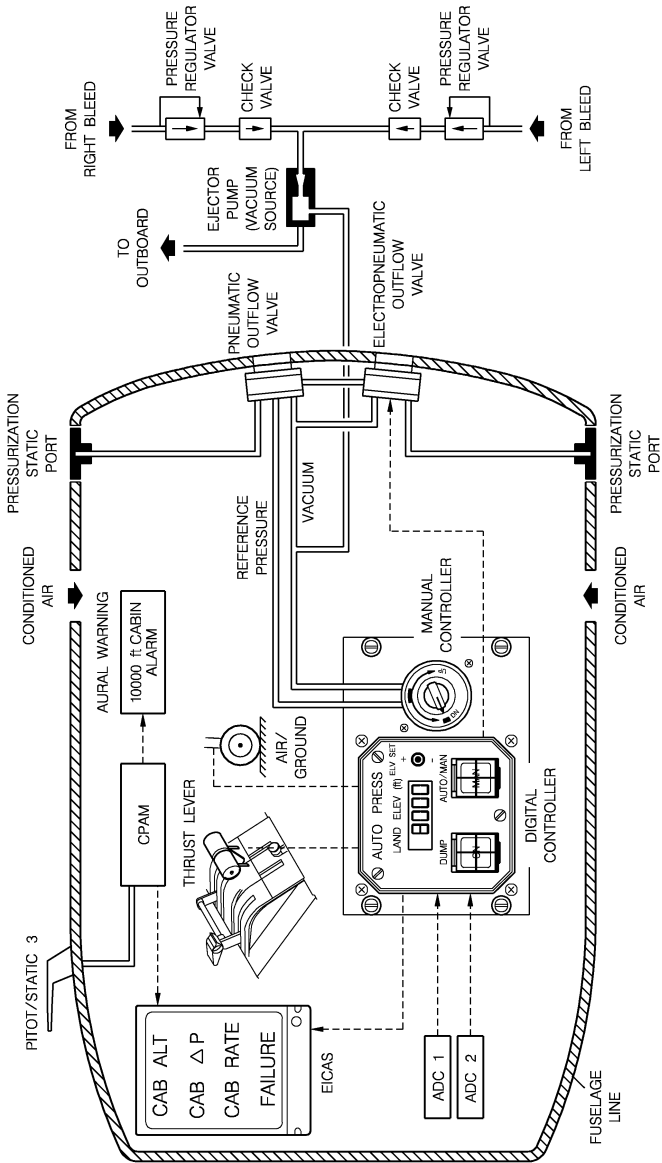

CABIN PRESSURE CONTROL SYSTEM SCHEMATIC

AUTOMATIC PREPRESSURIZATION SEQUENCE ON GROUND

This sequence is initiated and maintained as long as the airplane is on the ground and the engine 1 thrust lever is set to THRUST SET position or above. It causes the cabin altitude to descend toward an altitude equivalent to 0.2 psi (15 mbar) below the takeoff altitude.

The purpose of the automatic prepressurization is to avoid cabin bumps due to the irregular airflow on the fuselage during rotation and takeoff and also to keep a controlled cabin altitude just after rotation, as the cabin altitude tends to follow the airplane altitude.

In the case of takeoff with air conditioning supply, the cabin altitude is controlled with an altitude rate of descent equal to -450 ft/min.

In the case of takeoff without air conditioning supply, the outflow valves are closed, also avoiding cabin bump.

TAKEOFF SEQUENCE

This sequence is initiated after the airplane leaves the ground with the purpose of avoiding reselecting the landing altitude, in case it is necessary to return to the takeoff airport.

It causes the cabin altitude to continue descending towards the altitude equivalent to 0.2 psi below the takeoff altitude. If an altitude of 0.2 psi below the takeoff altitude has already been reached during the pre-pressurization sequence, the cabin altitude does not change.

The takeoff sequence lasts until the theoretical cabin altitude becomes greater than the actual cabin altitude, or until 15 minutes have elapsed since the sequence initiation, whichever occurs first.

FLIGHT SEQUENCE

This sequence is initiated after the takeoff sequence is finished, to establish a cabin altitude and a cabin altitude rate of change during flight. The Digital Controller schedules a cabin altitude that is the greatest value between the theoretical cabin altitude and the selected landing altitude minus 11 mbar (300 ft at SL).

The cabin altitude rate of change is controlled at different values depending on the scheduled cabin altitude and the airplane vertical speed, but is limited to -450 ft/min during descent and as following while climbing:

- 500 ft/min (for airplanes Pre-Mod. SB 145-21-0006);
- 600 ft/min (for airplanes Post-Mod. SB 145-21-0006 or S/N 145.050 up to 145.362);
- 700 ft/min (for airplanes S/N 145.363 and on).

Barometric correction, when required, is automatically provided by the Air Data Computer (ADC).

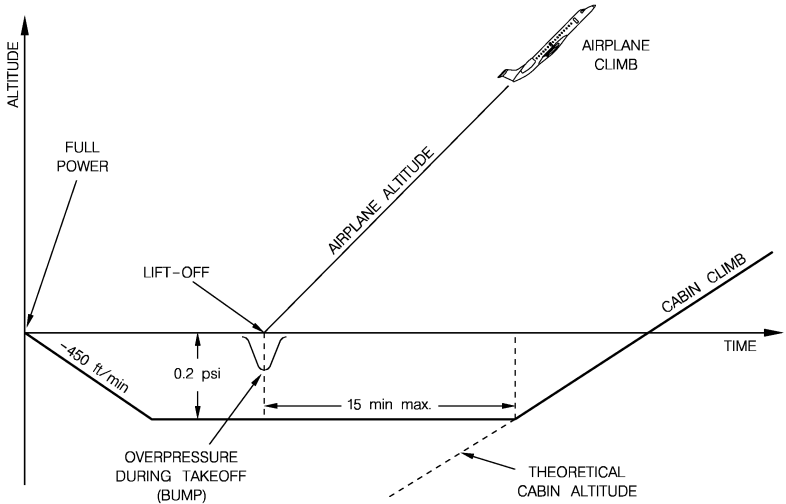

1451114160.MCE

AUTOMATIC PREPRESSURIZATION AND TAKEOFF SEQUENCE

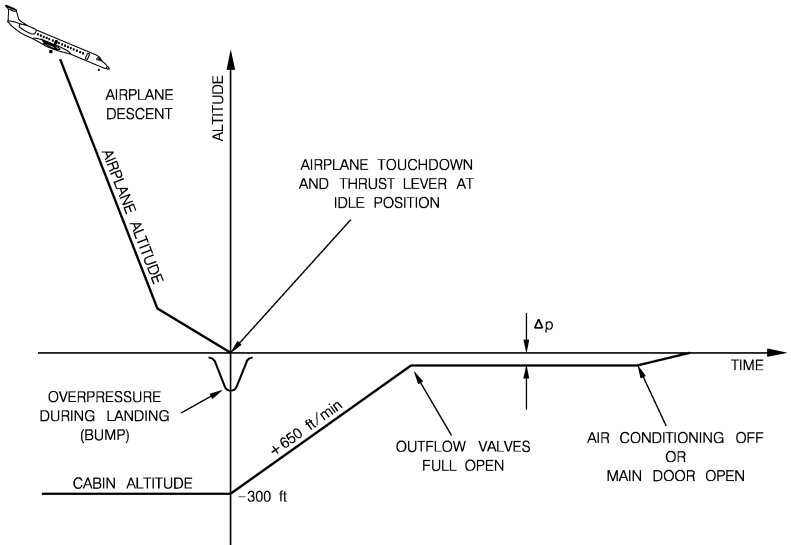

1451114161.MCE

AUTOMATIC DEPRESSURIZATION SEQUENCE ON GROUND

AUTOMATIC INCREASED RATE OF DESCENT SEQUENCE

This sequence is initiated when the airplane descent rate is greater than 200 ft/min, in order to satisfy all airplane rapid descent cases. The cabin altitude rate of change limits may be accordingly increased, depending on the remaining flight time which is calculated considering the airplane operating altitude, airplane vertical speed and the selected landing altitude.

Therefore, the cabin altitude rate of descent limit may be increased to a value between -450 ft/min and -1300 ft/min (for EMB 145 models Pre-Mod. SB 145-21-0006) or -450 ft/min and -500 ft/min (for EMB 145 Post-Mod. SB 145-21-0006 or S/N 145.050 and on, EMB-135 and ERJ-140 models).

AUTOMATIC DEPRESSURIZATION SEQUENCE ON GROUND

This sequence is initiated when the airplane is on the ground and the engine 1 thrust lever is in the IDLE position.

To avoid a cabin bump during the landing, it is necessary that the airplane land with the cabin being submitted to a small differential pressure. For that reason, the automatic mode always controls, for landing, a cabin altitude equal to the selected landing altitude minus 300 ft. This sequence cancels this differential pressure corresponding to 300 ft, as well as reduces cabin bump when the air conditioning is turned off or the main door is open.

Cabin depressurization is controlled at a rate of climb equal to 650 ft/min, up to the full opening of the outflow valves.

In automatic mode, the rapid cabin depressurization is commanded by the Dump Button.

OPERATION IN MANUAL MODE

Manual operation is accomplished through the manual controller which actuates only the pneumatic outflow valve, while the electropneumatic outflow valve is kept closed, by selecting MAN in the Pressurization Mode Selector Button and rotating the Manual Controller until the desired cabin rate of change is reached. The crew is responsible for monitoring cabin differential pressure within acceptable values.

In manual mode, the DUMP button is not effective and a rapid cabin depressurization is commanded by turning the manual controller to the UP position (clockwise stop). In this mode, the cabin altitude limitation at 15000 ft does not exist as it does in the automatic mode.

EICAS MESSAGE

TYPE	MESSAGE	MEANING
CAUTION	PRESN AUTO FAIL	Automatic pressurization mode failure.

CONTROLS AND INDICATORS

DIGITAL CONTROLLER

1 - LANDING ALTITUDE INDICATOR

- Displays the selected landing altitude.
- Displays a failure code if any failure is detected during power-up and continuous monitoring tests . In this case, the selection of the landing altitude is disabled.
- Successful power-up test is displayed (all light segments illuminated) until a landing altitude is selected.
- Displays blanks when Dump button or Mode Selector Button is pressed.

2 - LANDING ALTITUDE SELECTOR SWITCH

- Sets the landing altitude in the Landing Altitude Indicator.
- Altitude changes in 100-ft steps. Holding the selector for more than 5 seconds changes the altitude in a 1000 ft/sec rate.
- Landing altitude setting from -1500 ft to +14000 ft.

3 - PRESSURIZATION MODE SELECTOR BUTTON (guarded)

- Provides selection of either automatic mode (button released) or manual mode (button pressed) of operation.
- When pressed, the MAN inscription illuminates inside the button.

NOTE: In case of electrical failure that leads to the complete turning off of the automatic mode turning off, manual mode should be selected by pressing the Pressurization Mode Selector Button, but the MAN inscription will not be illuminated.

4 - PRESSURIZATION DUMP BUTTON (guarded)

- Provides rapid cabin depressurization up to 14500 ft.
- When pressed, an ON inscription illuminates inside the button.
- This button is effective in the automatic mode only.

MANUAL CONTROLLER KNOB

- Selects cabin rate of change between -1500ft/min (at DN position) and approximately +2500ft/min (at UP position), when in the manual operating mode.
- When operating in the AUTO mode, it must be set to the DN position.

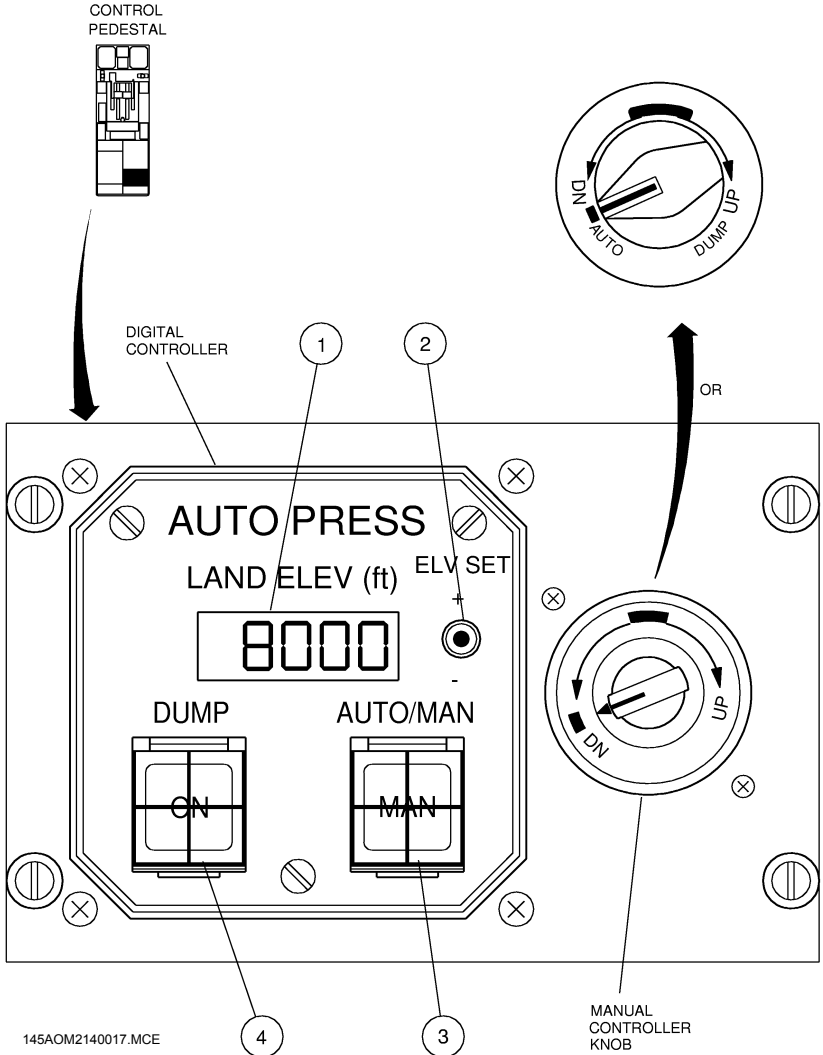

PRESSURIZATION CONTROLS AND INDICATORS

PRESSURIZATION INDICATION ON EICAS

1 - CABIN ALTITUDE INDICATION

- Displays cabin altitudes, regardless of the operating mode.
- Ranges from - 1500 to 37000 ft, with a resolution of 100 ft.
- Green: from - 1500 to 8000 ft (for EICAS versions up to 13).
 from - 1500 to 8100 ft (for EICAS version 14 up to 16).
 from - 1500 to 8300 ft (for EICAS version 16.5 and above).
- Amber: from 8100 to 9900 ft (for EICAS versions up to 13).
 from 8200 to 9900 ft (for EICAS version 14 up to 16).
 from 8400 to 9900 ft (for EICAS version 16.5 and above).
- Red: from 10000 to 37000 ft.

2 - DIFFERENTIAL PRESSURE INDICATION

- Displays the differential pressure between the cabin interior and the outside, regardless of the operating mode.
- Ranges from - 0.5 to 10.0 psi, with a resolution of 0.1 psi.
- Green: from 0.0 to 7.9 psi.
- Amber: from - 0.3 to - 0.1 psi and from 8.0 to 8.3 psi.
- Red: from - 0.5 to - 0.4 psi and from 8.4 to 10.0 psi.

3 - CABIN RATE OF CHANGE INDICATION

- Displays the cabin rate of change, regardless of the operating mode.
- Ranges from -2000 to 2000 ft/min, with a resolution of 50 ft/min.
- Green full range.
- For rates out of range the indication is replaced by amber dashes.

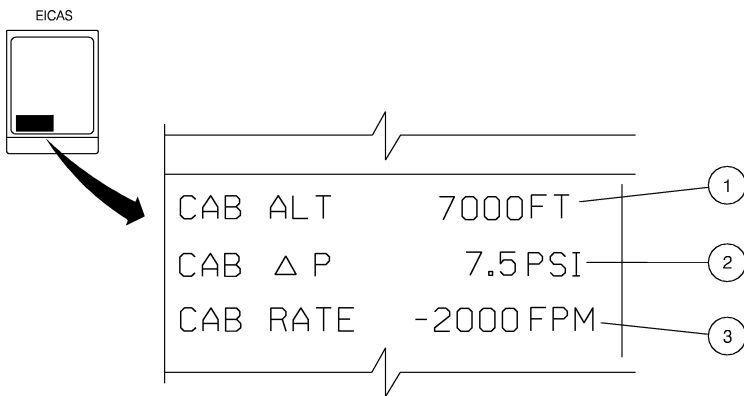

1451114057.MCE

PRESSURIZATION INDICATION ON EICAS

ELECTRONIC BAY COOLING SYSTEM

FORWARD ELECTRONIC BAY

An automatic cooling system is provided in the nose electronic bay, where most of the electronic equipment is installed. This system maintains the temperature inside the bay within the avionics operational limits.

The system comprises two NACA air inlets, two shutoff valves, two recirculation fans, two exhaust fans, two check valves, four control thermostats, and two overtemperature thermostats.

The NACA air inlets are provided with water separators and drains to deter water ingestion by the air inlets into the compartment.

All the fans are powered by four dedicated Inverter Modules.

When the airplane is energized, the inverter modules are turned on, supplying power to the recirculation fans.

The electrical power supply to the recirculation fan 2, exhaust fan 1 and shutoff valve 1 is completely segregated from the remaining components, to prevent a total loss of the system in case of an electrical system single failure. Each recirculation fan operates continuously when its associated bar is energized.

A check valve is installed on each exhaust duct (left and right) to avoid water ingestion through the exhaust fans.

If the forward electronic bay internal temperature exceeds 24°C (75°F) the control thermostats open the shutoff valves and turn the exhaust fans on. When the temperature drops below 19°C (66°F), the shutoff valves are closed and the exhaust fans are turned off.

In the event that the temperature limit is reached, two overtemperature thermostats are actuated and a caution message is presented on the EICAS.

REAR ELECTRONIC BAY

In flight or during operation with the doors closed, rear electronic bay cooling is performed by conditioned air discharged from the cabin. When this air flows from the underfloor area to the outflow valves, installed on the rear pressure bulkhead, it passes through this compartment, cooling it.

During ground operation, with the airplane unpressurized, an air outlet blows air from the gasper fan line towards the rear electronic bay.

EICAS MESSAGE

TYPE	MESSAGE	MEANING
CAUTION	ELEKBAY OVTEMP	Temperature inside the forward bay exceeds 71°C (160°F) maximum.

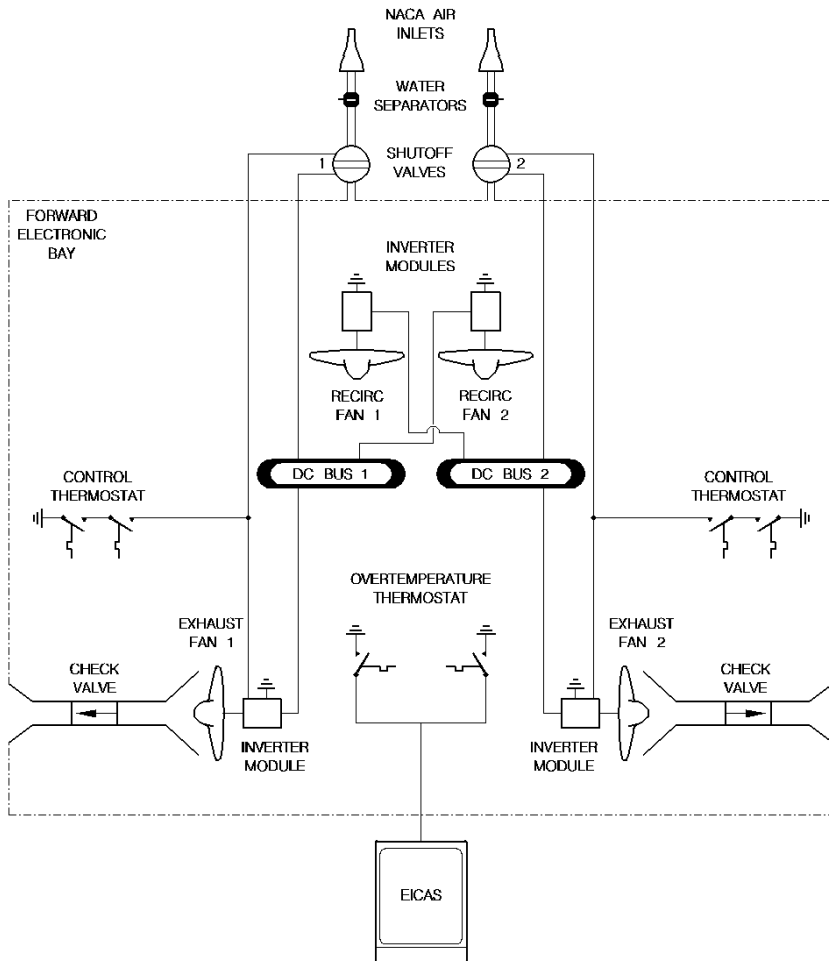

FORWARD ELECTRONIC BAY COOLING SCHEMATIC

1451114052.MCE

BAGGAGE VENTILATION SYSTEM

Airplanes equipped with “class-C” baggage compartment have a Baggage Ventilation System installed. Although no dedicated temperature control is available (the “class-C” baggage compartment is heated by the passenger cabin air flowing into it), the Baggage Ventilation System provides an adequate environment for carrying live animals in the compartment.

The Baggage Ventilation System is composed of two ambient check valves and a baggage compartment fan.

Whenever the recirculation fan is off, the forward check valve prevents reverse flow into the passenger cabin and the two check valves prevent smoke or fire extinguishing agent penetration into the passenger cabin or into the rear electronic compartment, (refer to Section 2-7 - Fire Protection).