

## TABLE OF CONTENTS

	<b>Page</b>
Introduction .....	17-1
Description .....	17-2
Engine Assembly and Airflow.....	17-2
Engine Modules .....	17-3
Full Authority Digital Electronic Control (FADEC) .....	17-4
Electronic Engine Controller (EEC).....	17-5
Engine Indications.....	17-8
Interturbine Temperature (ITT).....	17-9
ITT Indication .....	17-10
N2 Indication .....	17-11
Fuel Flow.....	17-11
Fuel Flow Indication .....	17-12
Oil Temperature .....	17-12
Oil Temperature Indication.....	17-12
Oil Pressure .....	17-12
Oil Pressure Indication.....	17-13
Engine Oil System.....	17-13
Engine Oil Heat Management System .....	17-15
Oil Replenishment System.....	17-16
Oil Replenishment Panel.....	17-17
Oil Replenishment Schematic.....	17-18
Engine Fuel System.....	17-19
Fuel System Schematic .....	17-21
Engine Bleed Air System .....	17-22
Thrust Management System.....	17-23
Thrust Levers .....	17-23
Engine Pressure Ratio (EPR) .....	17-26
EPR Rating Mode Selection.....	17-27
FMS Selection (EPR).....	17-29
EPR Control .....	17-30
N1 (Fan).....	17-31
N1 Control.....	17-32
N2 (HP Compressor).....	17-33
Engine Idle Control.....	17-34
Engine Fire Detection System.....	17-35
Engine Vibration Monitoring System (EVMS) .....	17-36
EVMS Indication.....	17-36
Starting and Ignition .....	17-37
Starter Air Valve (SAV) .....	17-38
Air Turbine Starter (ATS) .....	17-38
Ignition System.....	17-39
Engine Run Switches .....	17-41

Engine Starting.....	17-42
Auto Start - Ground.....	17-42
Rotor Bow.....	17-44
Auto Start - Air.....	17-45
Manual Start - Ground.....	17-45
Engine Shutdown.....	17-47
Dry Cranking.....	17-48
Wet Cranking.....	17-48
Starting Anomalies.....	17-49
Automatic Ground Start Abort.....	17-49
Manual Ground Start Abort.....	17-49
Automatic Air Start Abort.....	17-49
Auto-Relight.....	17-50
Quick Relight.....	17-50
Autothrottle System.....	17-51
Autothrottle (A/T) Data Sources.....	17-51
A/T Limiting.....	17-51
A/T Monitoring.....	17-52
Electronic Thrust Trim System (ETTS).....	17-52
SYNC Mode Selection.....	17-53
N1 SYNC On.....	17-53
N2 SYNC On.....	17-54
EPR CMD SYNC On.....	17-54
N1, N2, EPR CMD SYNC Off.....	17-55
Sync Annunciation.....	17-55
A/T 1 or 2 Select.....	17-56
A/T Engagement/Disengagement.....	17-56
A/T Disengagement.....	17-57
A/T Disengagement and Manual Override.....	17-58
A/T Mode Operation.....	17-59
Takeoff Thrust Control Mode.....	17-60
Takeoff Thrust Hold Control Mode.....	17-60
Flight Level Change Thrust Control Mode.....	17-61
Airspeed Control Mode.....	17-62
Retard Mode.....	17-63
Go Around Thrust Control Mode.....	17-63
Thrust Reverser System.....	17-64
Thrust Reverser.....	17-64
Reverse Thrust Operation.....	17-66
Reverser Components.....	17-67
Directional Control Unit.....	17-67
Reverse Thrust Levers.....	17-69
Reverser System Lockout.....	17-70
Power Plant EICAS Messages.....	17-71
EMS Circuit Protection.....	17-75

## INTRODUCTION

The Global airplane is powered by two BMW-Rolls Royce BR710A2-20 engines, each mounted on a pylon on either side of the rear fuselage.

The engine is an axial flow, dual shaft turbofan, with a 4.0:1 bypass ratio, with a rated static thrust of 14,750 pounds at sea level to ISA + 20.

The BR710A2-20 engine contains two main rotating assemblies (spools), a single-stage low pressure (LP) fan-driven by a two-stage turbine, and a ten-stage high pressure (HP) compressor, driven by a two-stage turbine. The HP spool provides an external drive for the accessories mounted on the accessory gearbox.

The engine is made up of eight modules as follows:

- Fan assembly
- Fan case
- Intermediate case
- HP Compressor
- HP Turbine and combustion chamber
- LP Turbine and shaft
- Accessory Gearbox (AGB)
- Bypass duct

Each engine provides bleed air extraction, from either the 5th stage or the 8th stage of compression, for Air Conditioning/Pressurization, Cowl and Wing anti-icing and engine starts.

The engine oil system consists of a lubrication system, a heat management system and an oil replenishment system.

The fuel system consists of a low-pressure system and a high-pressure system. Fuel is supplied from the airplane fuel system via AC and/or DC fuel pumps and engine-driven fuel pumps.

Thrust management is controlled throughout all phases of operation by the Full Authority Digital Electronic Control (FADEC). An Electronic Engine Controller (EEC) is the major part of the FADEC, interfacing between the airplane and the engine.

Primary engine indications are displayed on EICAS and secondary indications on the STATUS page.

Autothrottle is controlled by the autothrottle computer, located in the IAC, and sends signals to FADEC via the throttle, for thrust commands.

Starting is initiated through the FADEC, to provide normal ground/air starts, alternate ground/air starts, wet and dry motoring and continuous ignition. Starting can also be performed manually.

The thrust reverser system is operated by the airplane hydraulic system and is controlled by the EEC.

Vibration monitoring system provides signals indicating N1 (Fan) and N2 (HP compressor) vibration levels on each engine.

Fire detection is provided by dual element sensor assemblies connected in series to provide two independent sensing loops. Two fire bottles are located at the rear of the airplane.

## DESCRIPTION

### ENGINE ASSEMBLY AND AIRFLOW

The BR710A2-20 engine contains two main rotating assemblies (spools), a single-stage low-pressure (LP), fan-driven by a two-stage turbine, and a ten-stage high pressure (HP) compressor, driven by a two-stage turbine. The HP spool provides an external drive for the accessories mounted on the accessory gearbox.

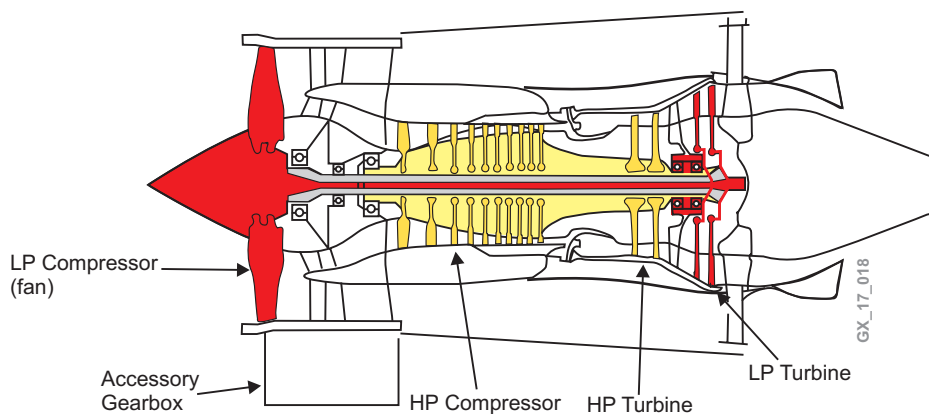

All air entering the engine air intake passes through the LP compressor and is divided into two main flows, the bypass and core airflows. The core airflow passes through the HP compressor to the annular combustion chamber, which supplies the engine with its fuel requirements. The core airflow then flows through two stages of HP turbines and two stages of LP turbines into the forced mixer to mix with bypass air.

The bypass air passes through the fan outlet guide vanes along the bypass duct to meet with the core airflow. The combined airstream is exhausted to atmosphere.

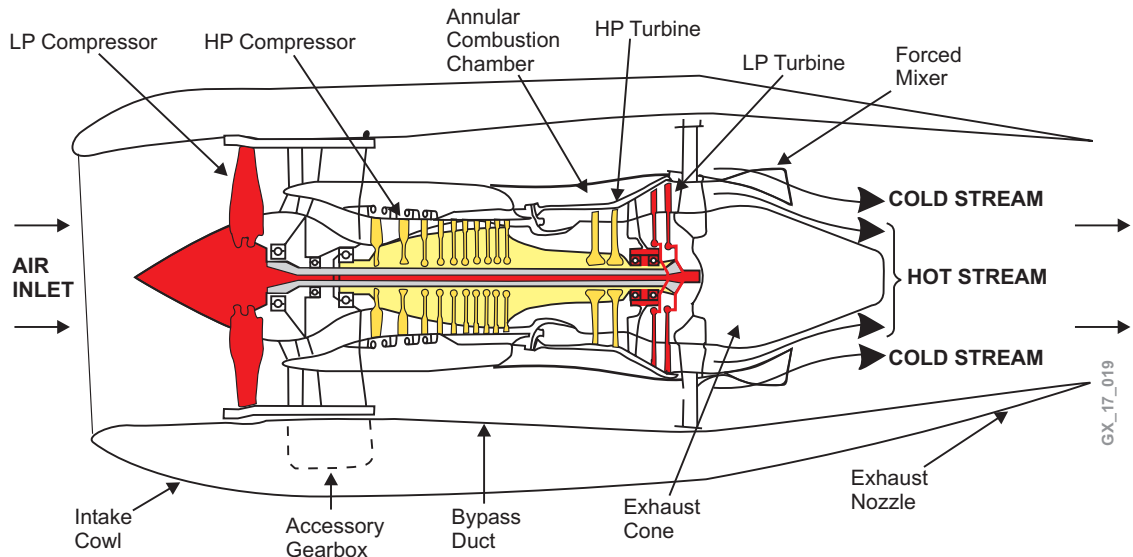

GX\_17\_019

**ENGINE MODULES**

The engine is made up of eight modules as follows:

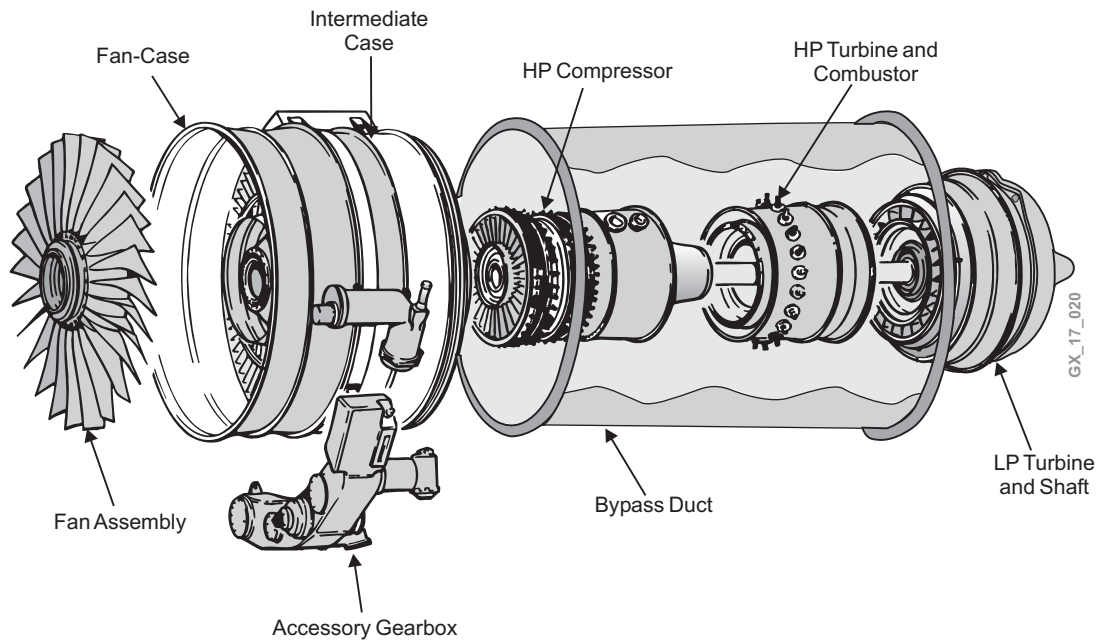

GX\_17\_020

- Fan assembly - Compresses the air entering the engine inlet cowl and feeds a percentage of it to the core, while the bypass air provides a major portion of the engine's thrust
- Fan case - Provides containment in the event of fan blade failure and noise attenuation
- Intermediate case - Provides a fixed structure for rotating systems and houses the drive for the AGB
- HP Compressor - Provides a pressurized airflow to the combustion chamber for combustion and cooling purposes and pressurized air for ECS and Wing and Cowl anti-icing
- HP Turbine and combustion chamber - The two stage HP turbine drives the HP compressor. The combustion chamber mixes fuel and air, for an optimum mixture, for maximum efficiency
- LP Turbine and shaft - Provides the LP turbine shaft which drives a two stage LP turbine that drives the LP compressor (fan)
- Accessory Gearbox (AGB) - Transmits the motoring force from the engine to the accessories mounted on the AGB. The AGB also transmits motoring from the air starter to the engine during start/crank procedures. The AGB also houses the integral oil tank
- Bypass duct - Provides a streamlined path for the fan bypass airflow and supports the thrust reverser unit

### **FULL AUTHORITY DIGITAL ELECTRONIC CONTROL (FADEC)**

Thrust management is controlled throughout all phases of operation by the Full Authority Digital Electronic Control (FADEC). An Electronic Engine Controller (EEC) is the major part of the FADEC, interfacing between the airplane systems and the engine.

The EEC provides the following control functions:

- Fuel metering through the FMU for:
  - Automatic start and relight
  - Idle speed control
  - Acceleration and deceleration
  - Engine power setting
  - Limit protection for N1 and N2 speeds
  - Limit protection for temperature
  - Independent overspeed protection of N1 and N2

- Compressor airflow control via the and HP compressor bleed valves, to ensure:
  - Surge free acceleration and deceleration
  - Surge recovery
  - Stable operation
- Control of oil and fuel temperature
- Control of the igniters and start air valve
- Partial control of the thrust reverser system functions
- Control of the engine power in reverse thrust
- Control of system electrical supply, either 28 or dedicated generator output to the EEC and through to the FADEC

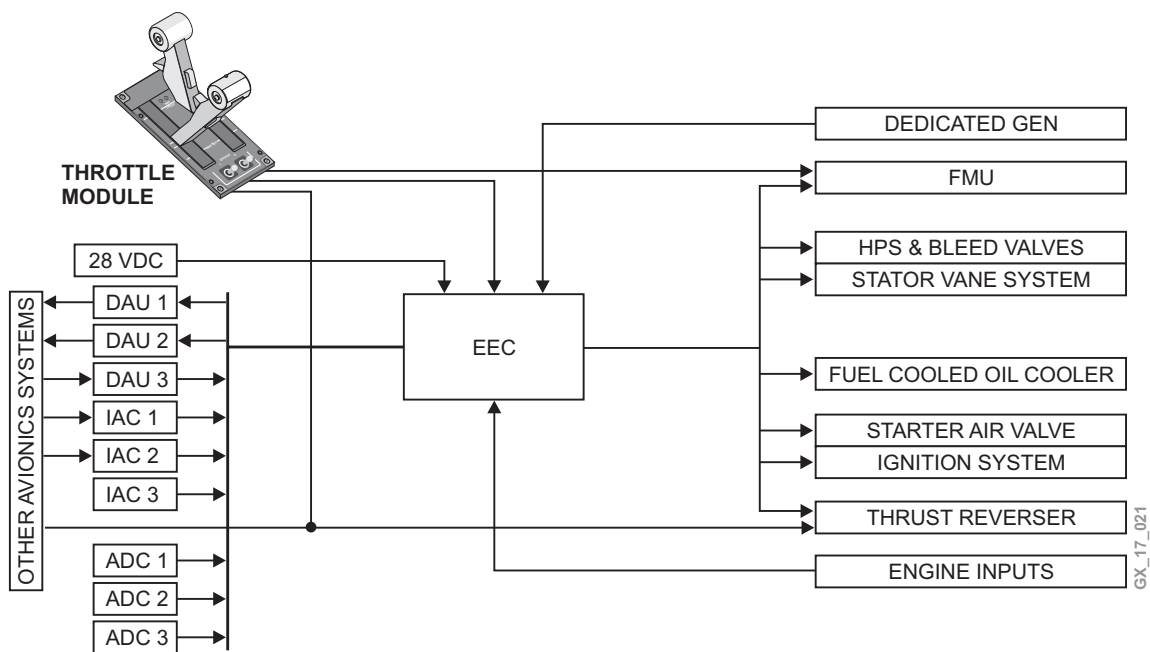

### ELECTRONIC ENGINE CONTROLLER (EEC)

The EEC is the controlling unit of the FADEC system and is located on the top of the engine.

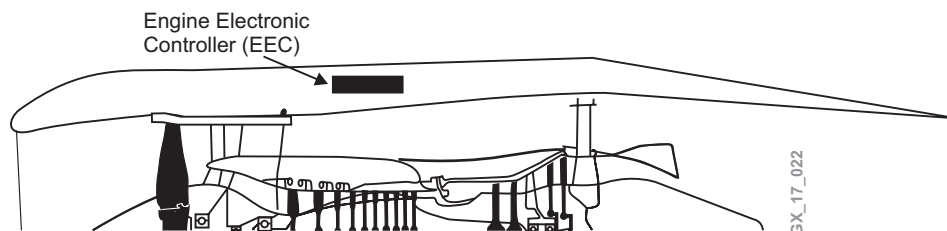

The EEC is an electronic control unit containing two channels A and B. Each channel is comprised of a Central Processor Unit (CPU), Power Supply Unit (PSU) and an Independent Overspeed Protection (IOP) unit.

The PSU controls the power supplies to the FADEC system and to the EECs, CPU and IOP.

The PSU controls the switch over from the airplane 28 VDC supply to power supplied by the Dedicated Generator (DG). Normally the FADEC is powered by the DG when the engine is operating. If DG power fails, the PSU will revert to the airplane power supply, to continue operation of the engine. The DG is mounted on the front of the accessory gearbox.

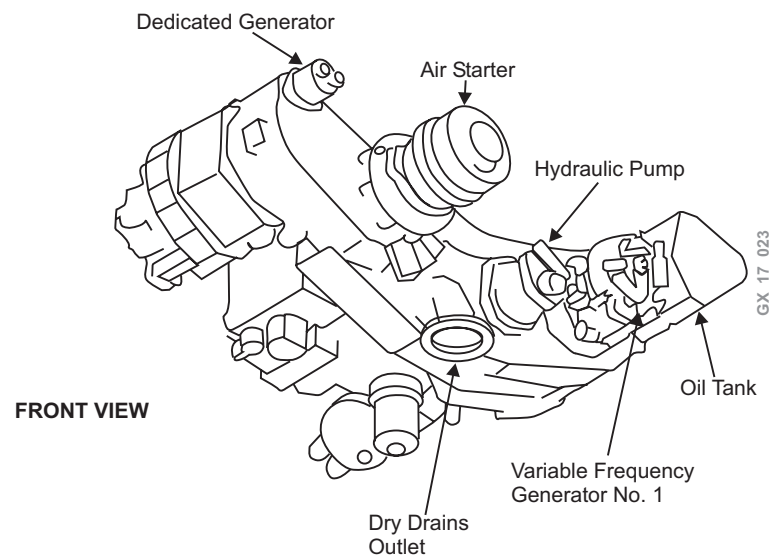

The CPU receives and processes all input signals and calculates the output signals. Control of the engine automatically alternates between channel A and channel B. If channel A is in control, channel B is the backup for the duration of that flight. On the next engine start channel B is in control and channel A is backup. The change command is triggered by the engine shutdown on the ground. An interlock prevents both channels from being in control at the same time. Each CPU's operation is monitored by a "watchdog timer". If the watchdog timer senses a CPU malfunction within a set timescale, then it will momentarily pass control to the other channel, while the faulty CPU resets. After four CPU resets the watchdog will impose a freeze and control will pass to the other channel for the remainder of the flight.



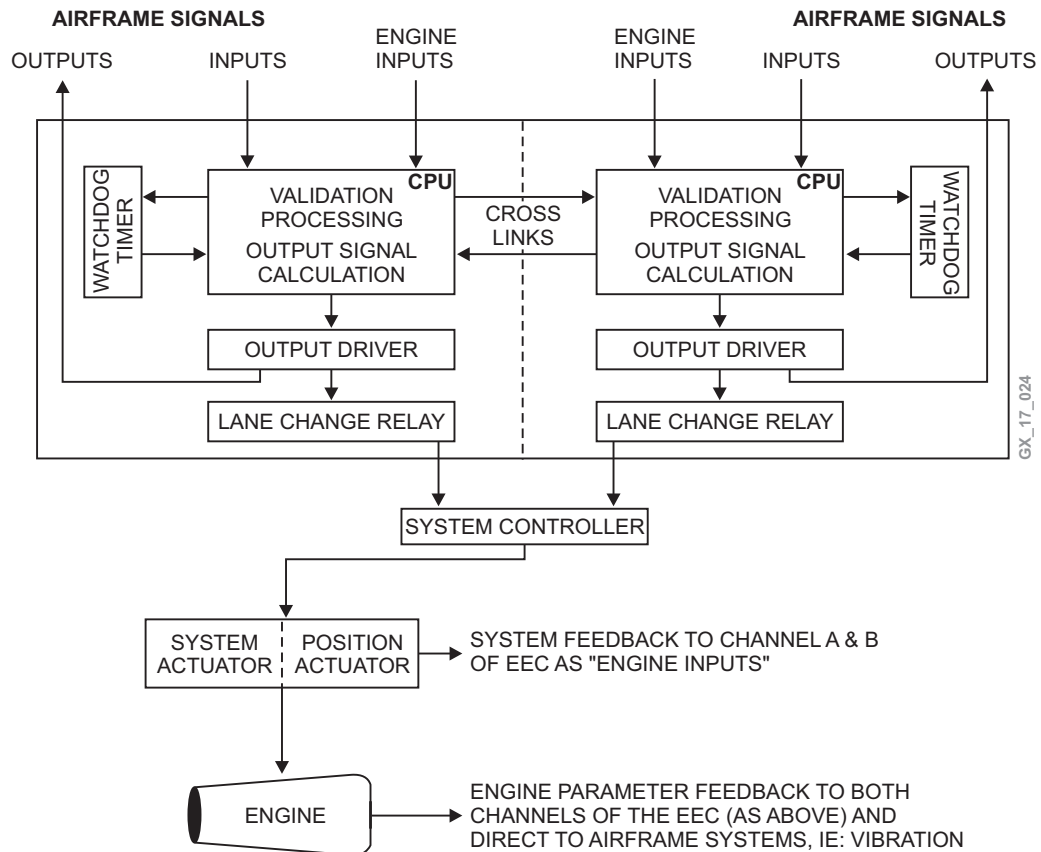

The IOP will automatically shut off fuel in the event of N1 or N2 reaching the overspeed trigger values. When either N1 or N2 speed signal has exceeded a preset value, one of the IOPs will “vote” to close the HPSOV, located in the FMU and indicate this to the other channel via the cross link. The engine will not shut down unless both IOPs detect an overspeed. The overspeed function is checked during normal engine shutdown by resetting the overspeed trip points to a subidle value. When the speed drops below the reset values, the IOP overspeed detection trip points logic resets.

## ENGINE INDICATIONS

Primary engine parameters are displayed on EICAS. Secondary engine parameters are displayed on the STAT page.

### Engine Pressure Ratio (EPR)

Used to display thrust and is the primary thrust setting indicator.

### N1 (FAN)

Used to display the LP compressor (fan) speed, and as Secondary thrust setting indicator and is measured in %.

### Interturbine Temperature (ITT)

Used to display engine operating temperatures and is displayed in °C.

### N2 (HP compressor)

Used to display HP compressor speed and is measured in %.

### Fuel Flow (FF)

Used to display the amount of fuel being used, in pounds per hour (pph) or kilograms per hour (kgph).

### Oil Temperature (OIL TEMP)

Used to display the oil temperature and is displayed in °C.

### Oil Pressure (OIL PRESS)

Used to display the oil pressure and is displayed in psi.

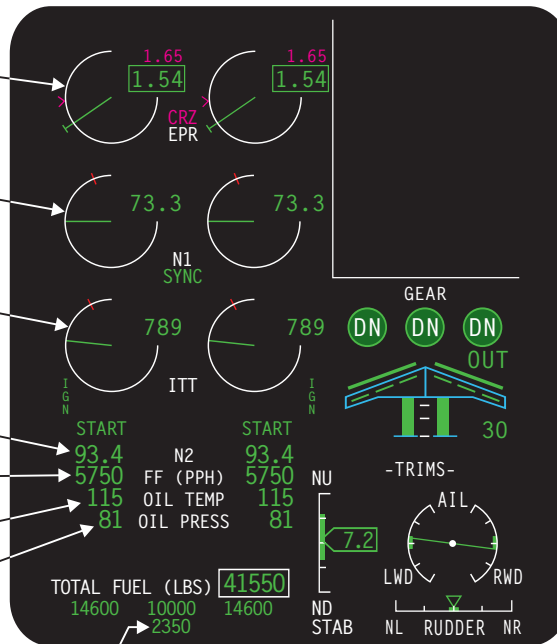

**Aft Tank**  
Not shown on Global 5000

### Engine Oil Quantity (ENG)

Used to display the oil quantity in the engine and is measured in quarts.

### Oil Reservoir Quantity (RES)

Used to display the amount of oil in the replenishment tank and is measured in quarts.

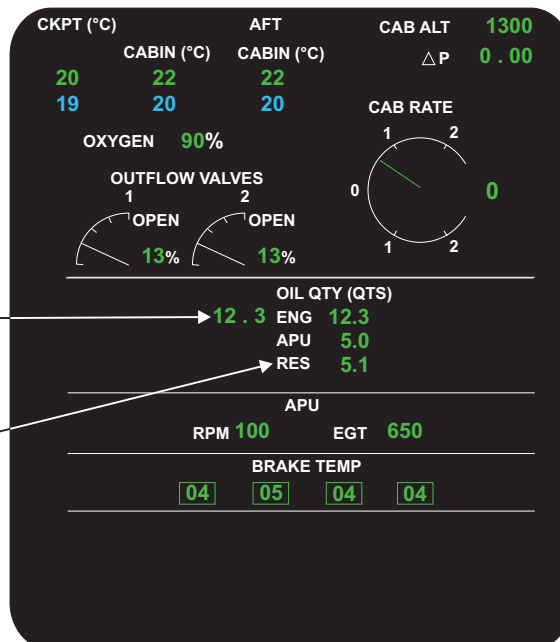

GX\_17\_025

## INTERTURBINE TEMPERATURE (ITT)

ITT measures engine operating temperatures and is used by the EEC during engine start and relight.

Seven dual element (dissimilar metals) thermocouples, located in the LP turbine entry area, are connected in parallel and provide an average ITT to each lane of the EEC.

A data entry plug ensures that all engines have the same ITT redline. The redline will change value depending on the start configuration, ground or inflight.

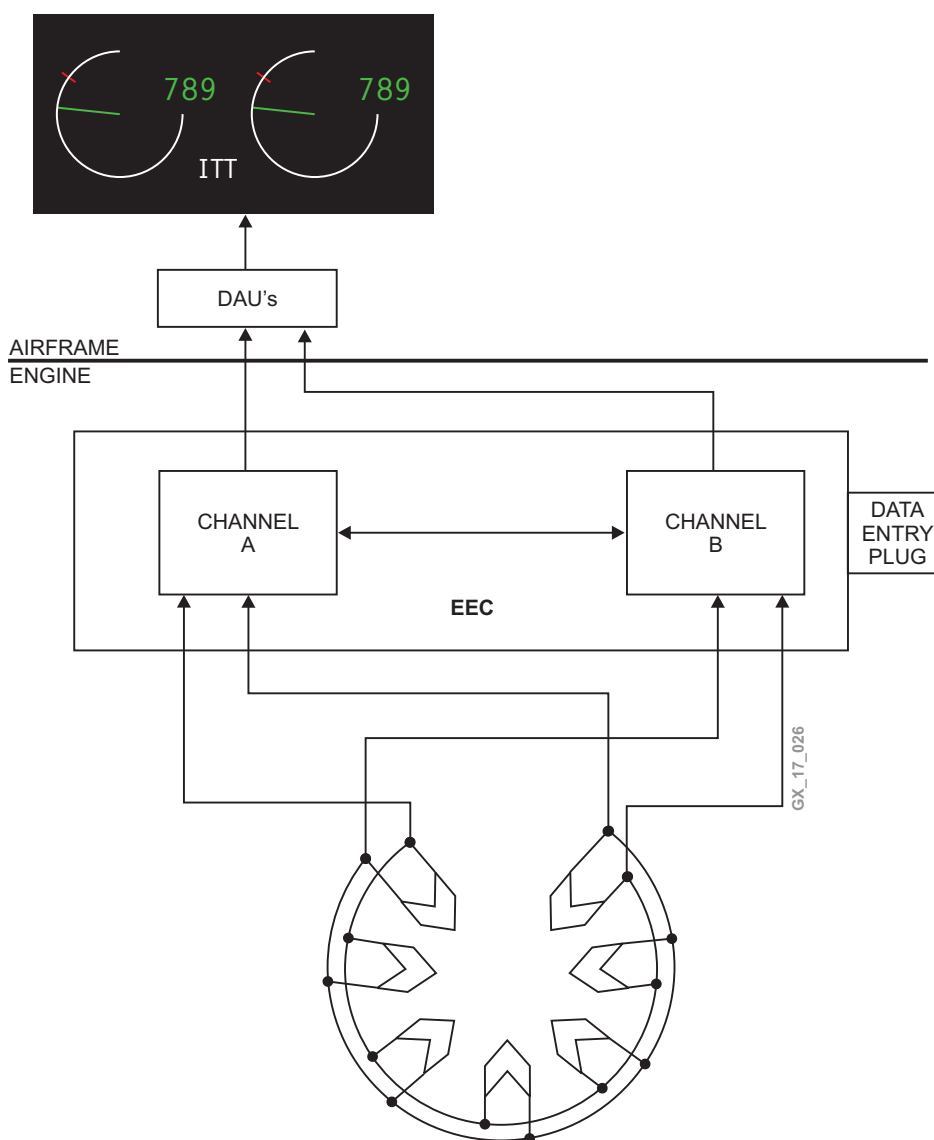

## ITT INDICATION

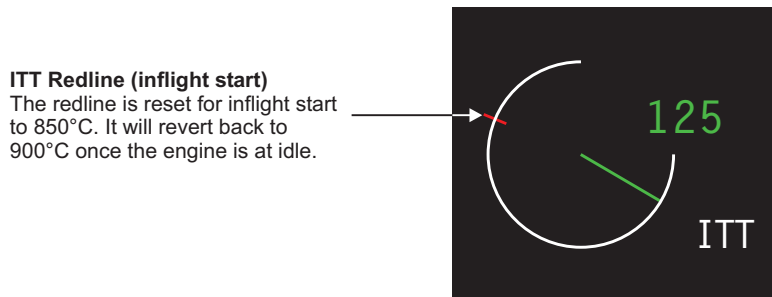
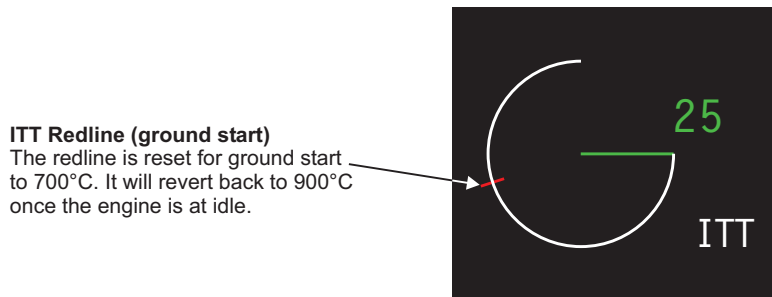
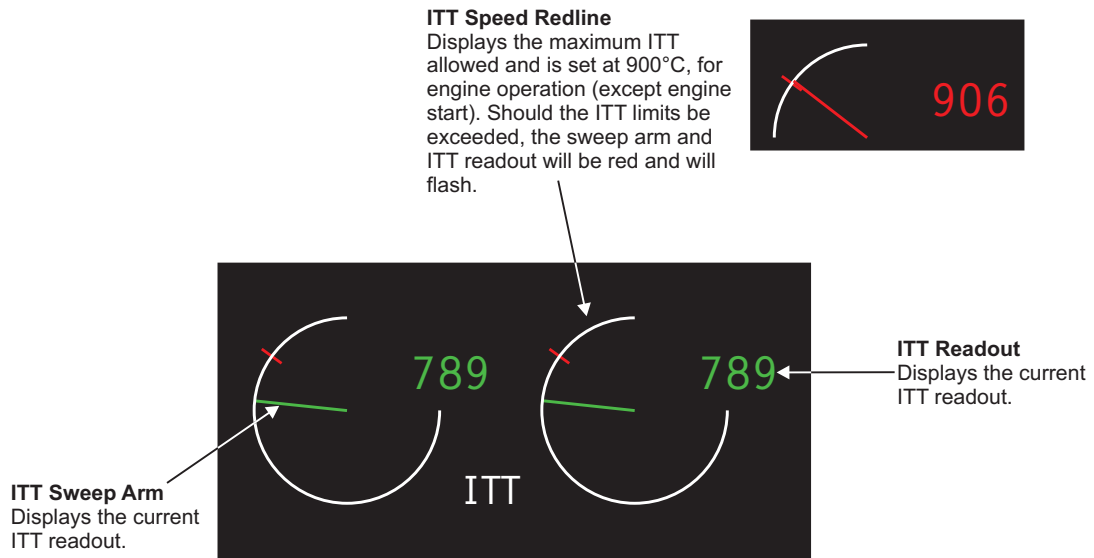

GX\_17\_027

## N2 INDICATION

93.4	N2	93.4	<b>N2 Readout</b> Displays the current N2 readout.
5750	FF (PPH)	5750	
115	OIL TEMP	115	
81	OIL PRESS	81	

**N2 Amberline**  
 If the N2 speed limit is exceeded the N2 readout will turn amber. The amberline is set at > 98.9% N2, or greater.

→ 99.0	N2	
5750	FF (PPH)	
115	OIL TEMP	
81	OIL PRESS	

**N2 Redline**  
 If the N2 speed exceeds the amberline limits, the N2 readout will turn red and will flash. The redline is set at  $\geq 99.6\%$  N2, or greater.

→ 99.8	N2	
5750	FF (PPH)	
115	OIL TEMP	
81	OIL PRESS	

**N2 Readout with Wing Anti-Ice Active**  
 If N2 RPM is < 76% N2 with WAI active (AUTO or ON) the N2 readout will turn white.

→ 75.8	N2	
5750	FF (PPH)	
115	OIL TEMP	
81	OIL PRESS	

If N2 RPM is  $\geq 76\%$  N2 then the N2 readout will turn green.

→ 77.0	N2	
5750	FF (PPH)	
115	OIL TEMP	
81	OIL PRESS	

GX\_17\_028

## FUEL FLOW

The fuel flow transmitters will send a signal of engine consumed fuel flow to the EEC. Fuel flow is either displayed in pounds/hour (pph) or kilograms/hour (kph), depending on customer specifications.

## FUEL FLOW INDICATION

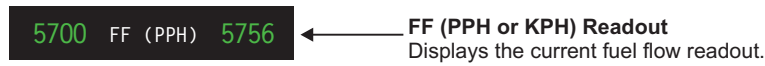

GX\_17\_029

## OIL TEMPERATURE

Oil cooling is achieved by the Fuel Cooled Oil Cooler (FCOC). The oil temperature bulbs provide temperature to the EEC.

## OIL TEMPERATURE INDICATION

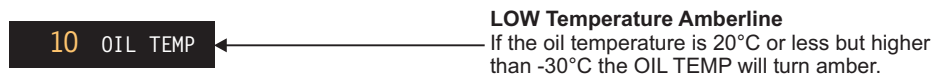
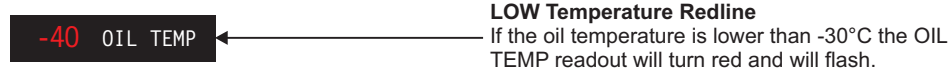
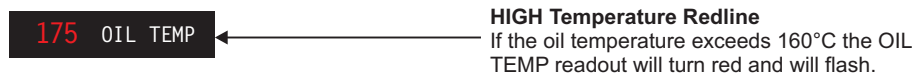

GX\_17\_030

## OIL PRESSURE

The oil pressure transducer provides an indication of the pressure between the oil feed and scavenge lines.

## OIL PRESSURE INDICATION



**OIL PRESS Readout**  
Displays the current oil pressure readout.



**Low Pressure Redline**  
if the oil pressure is 25 psi or lower, OIL PRESS readout will turn red and will flash.



**Low Pressure Amberline**  
The minimum low press amberline is N2 dependent as follows:

GX\_17\_031

MINIMUM OIL PRESSURE - N2 DEPENDENT			
N2	GROUND	FLIGHT	
50%	35 psi	25 psi	10 seconds time delay
72.3%	35 psi	25 psi	
90%	45 psi	35 psi	

## ENGINE OIL SYSTEM

The function of the oil system is to lubricate and cool the engine bearings and gears. The system is a full flow recirculating type.

The oil for the engine is stored in a tank, which is an integral part of the accessory gearbox. An oil pump will take the oil from the tank to supply the front bearing chamber, the rear bearing chamber and the accessory gearbox, via an oil pressure filter and a fuel cooled oil cooler (FCOC). An oil replenishment tank is located in the aft equipment bay.

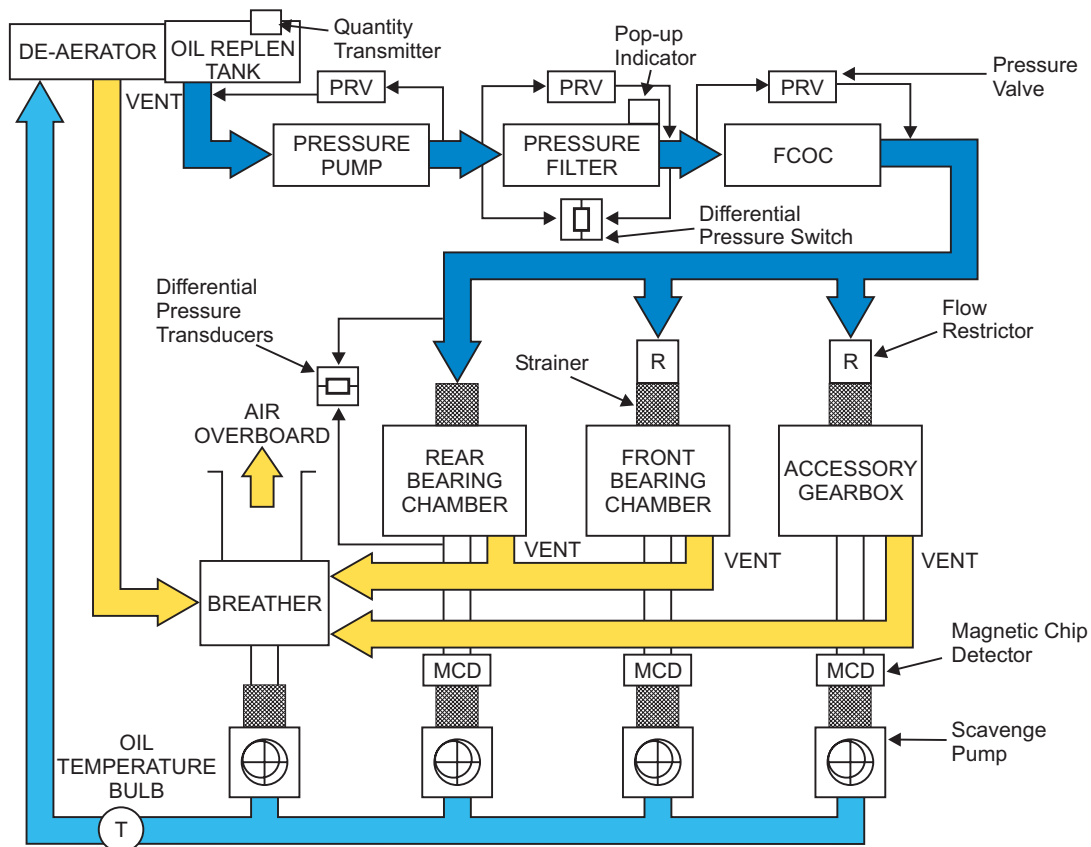

GX\_17\_032

The oil quantity transmitter provides indication to the STATUS page and will display an OIL LO QTY message if the oil quantity is low.

The pump supplies pressure to move the oil to the bearings and drive gear and to return it to the tank. The oil pressure transducer provides an indication of the pressure between the oil feed and scavenge lines and displays it on EICAS.

If the oil pressure is low, while the engine is running, an OIL LO PRESS message is displayed on EICAS.

Oil is fed to the pressure filter. The filter removes debris prior to delivery to the bearing/gears. A pressure relief bypass valve allows oil to bypass the filter in the event of filter blockage, and an OIL FILTER message will be displayed on EICAS, indicating an impending bypass.

The oil temperature bulbs provide oil temperature to the Electronic Engine Controller (EEC). This data is used by the Heat management System and is also sent to EICAS.



### ENGINE OIL HEAT MANAGEMENT SYSTEM

The cooling is achieved by the Fuel Cooled Oil Cooler (FCOC). The oil cooler dissipates the engine oil system heat by exchanging heat between engine lubricating oil and low pressure fuel. It also warms the low temperature fuel to prevent the formation of ice particles in the fuel entering the Fuel Metering Unit (FMU).

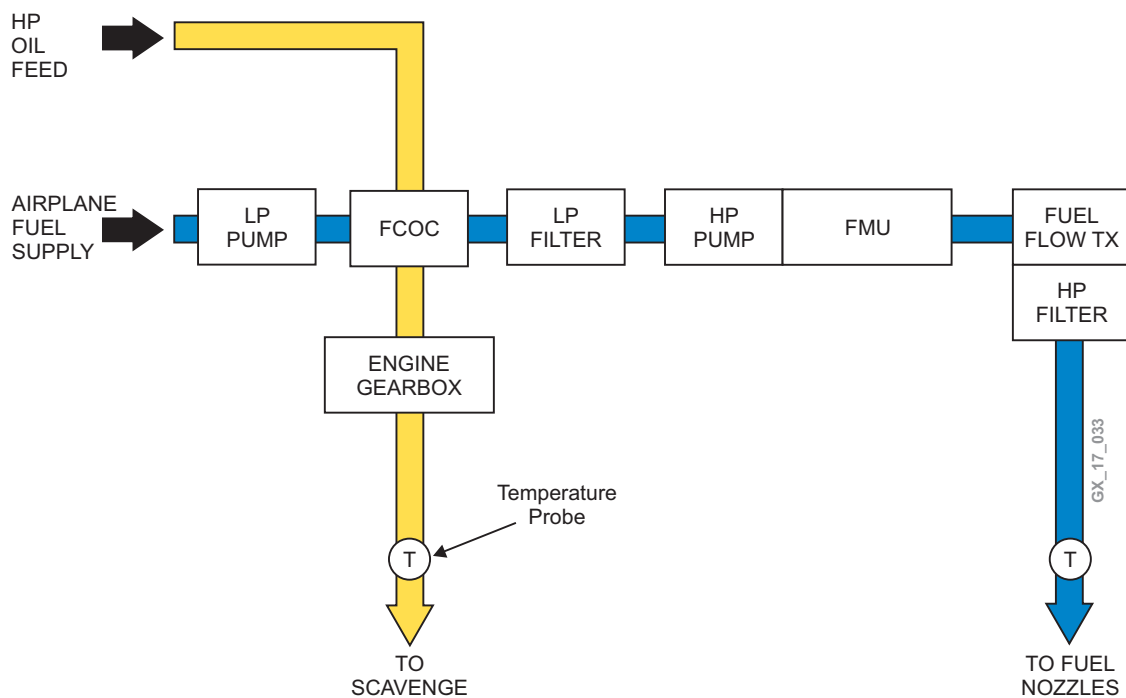

## OIL REPLENISHMENT SYSTEM

Each engine oil tank capacity is 13.6 U.S. quarts (12.86 liters). Engine oil level is measured using a sensor (oil probe) which is located in the engine oil tank and provides quantity information on the STATUS display.

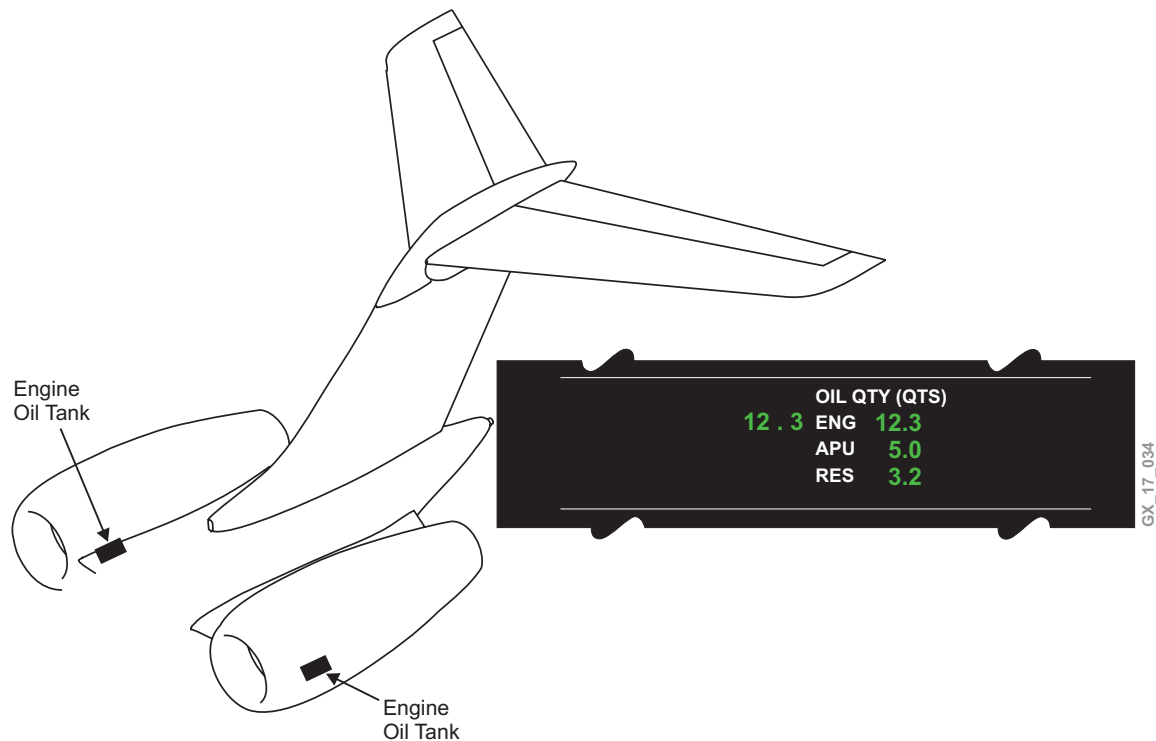

An oil replenishment tank is located in the aft equipment bay and contains an electrical pump and sensor probe for quantity level. The oil replenishment tank volume contains 6 U.S. quarts (5.7 liters). The oil replenishment system is designed for ground use only and serves both main engines and the APU.

The system can be operated using the battery or external electrical power. Oil level monitoring is required during servicing the engine(s) to verify that the system stops when the full level is reached. It is recommended to stop replenishment manually when gauge reads 11.0 quarts.

The oil filling system is operated through the oil replenishment panel located behind the pilot's seat in the flight compartment. The panel will display all lights for a period of three seconds when the panel is powered up.

Each engine may be replenished individually if:

- Both engines are shut down
- The engine to be replenished has been shut down for a minimum of 5 minutes and to a maximum of 30 minutes

- To replenish the APU it has to have been shut down for a minimum of 15 minutes
- The engine to be replenished is not already full
- One of the other engines or APU is not currently being replenished
- The aircraft has Weight on Wheels (WOW)

## OIL REPLENISHMENT PANEL

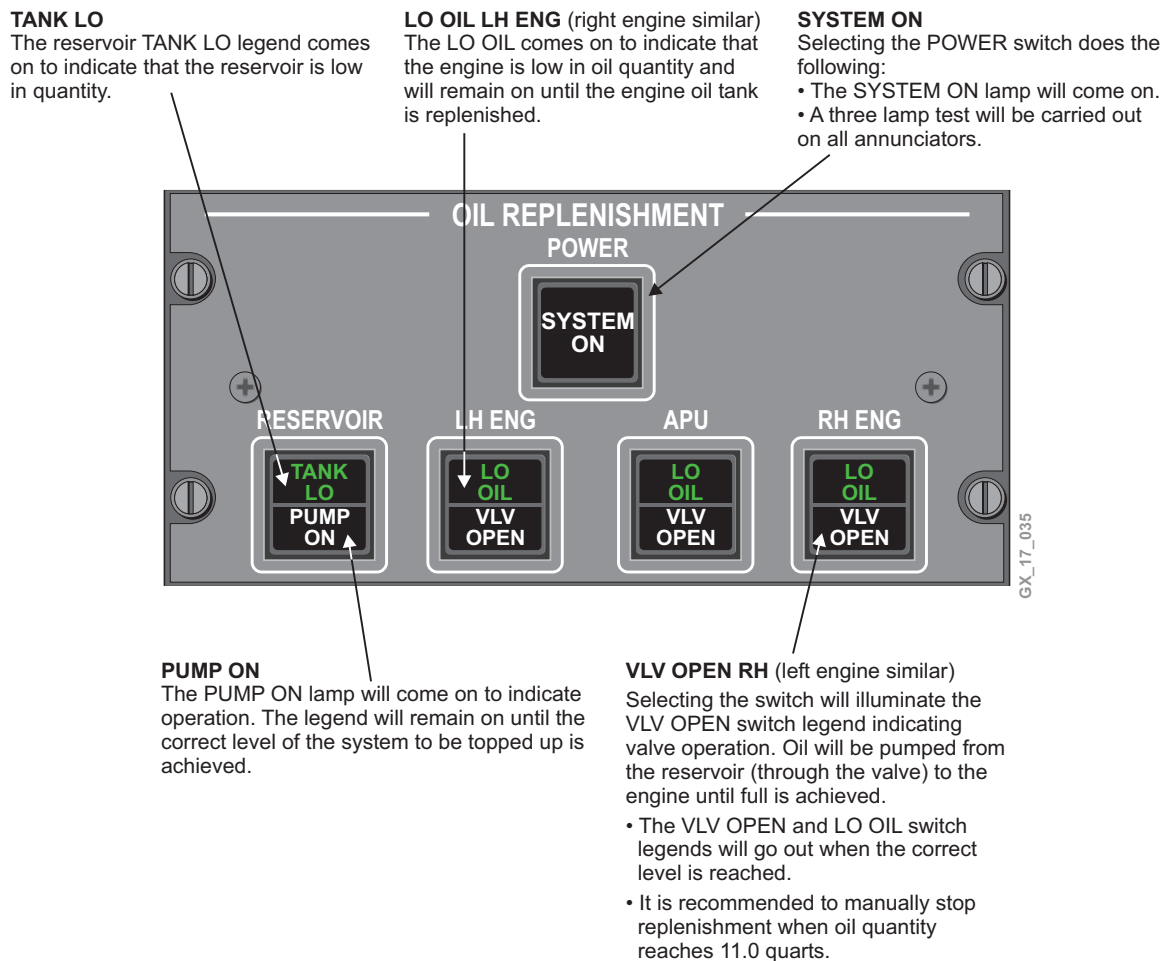

## OIL REPLENISHMENT SCHEMATIC

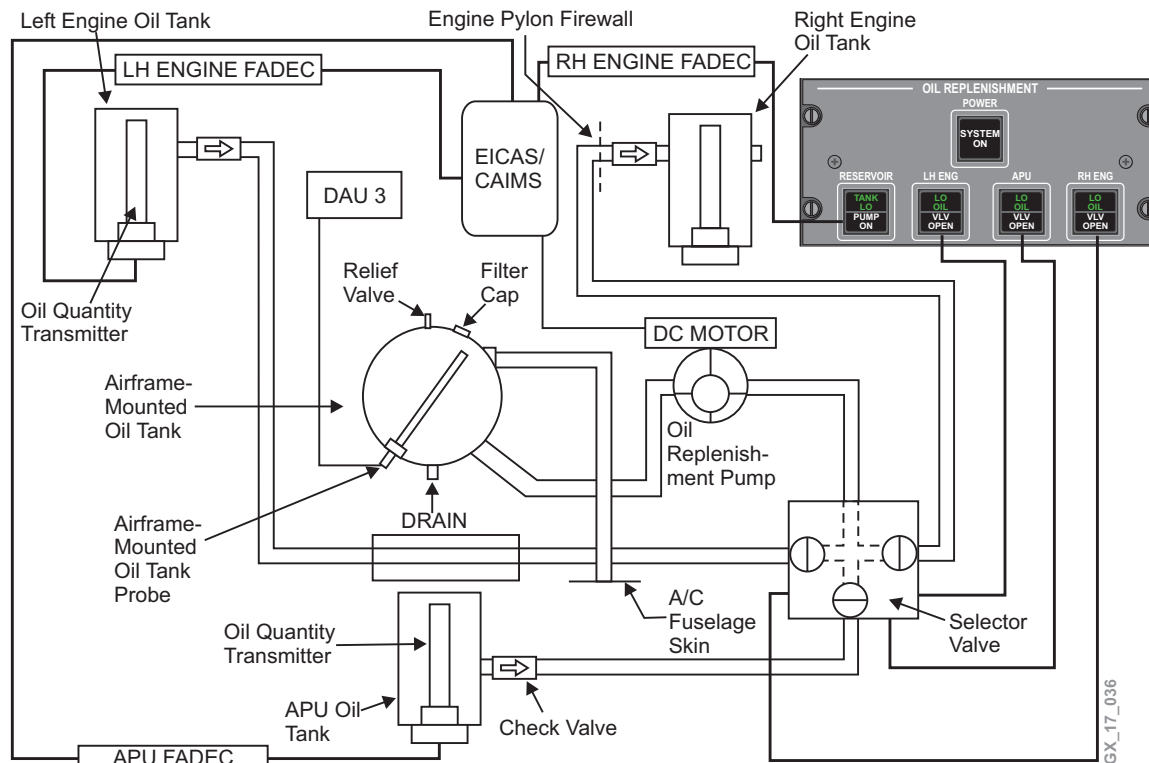

The following procedural steps outlined are to be used only as a guide to replenish the engine oil system. The Airplane Maintenance Manual takes precedence over all servicing procedures.

- Select the POWER switch on the oil replenishment panel, SYSTEM ON legend on
- Confirm that the LO OIL lamp on the oil replenishment panel corresponds to the condition indicated on EICAS L-R OIL LO QTY caution message (if message present)
- Select the switch labeled LH or RH ENG on the oil replenishment panel
- Confirm that the PUMP ON (below reservoir label) and VLV OPEN (below the engine to be filled) legends are displayed on the oil replenishment panel
- Monitor the oil level on EICAS for both the engine and reservoir (example: if approximately 1 liter or 1 U.S. quart is added to the engine, the oil replenishment tank level should have reduced by the same amount)
- When the engine reaches maximum level confirm that the PUMP ON legend on the oil replenishment panel goes out (indicating pump stops). Also confirm that the VLV OPEN legend on the oil replenishment panel goes out (indicating valve closed)
- It is recommended to manually stop the replenishment when the gauge reads 11.0 quarts to avoid overservicing

## ENGINE FUEL SYSTEM

The fuel system provides engine fuel for combustion, HP compressor Variable Stator Vanes (VSV) actuation and engine oil cooling.

The main components that are contained in the fuel system are as follows:

- Fuel Pump Unit - The fuel pump unit contains both the LP and HP pumps. Fuel supplied from the airplane fuel system passes through the (centrifugal type) LP pump, is pressurized and is delivered to the Fuel Cooled Oil Cooler (FCOC)
- LP Filter - Fuel from the FCOC enters the LP fuel filter, where any debris is trapped before proceeding on to the HP pump. The fuel filter contains a combined DP switch/indicator. The combined unit provides indications on EICAS of low pressure fuel or an impending LP fuel filter blockage. A FUEL FILTER message will be displayed on EICAS. A fuel low pressure switch is also provided to alert the crew of low fuel pressure in the supply line to the HP pump. A FUEL LO PRESS message will be displayed on EICAS
- HP Fuel Pump - The HP fuel pump increases the pressure of the fuel for delivery to the Fuel Metering Unit (FMU)
- The FMU meters the fuel required by the engine in response to the Electronic Engine Controller (EEC) and provides pressure which is used as a motive force for the VSVs. The variable inlet guide vanes and the first three stages of stators of the HP compressor adjust the airflow entering the compressor to assist during engine starts, help prevent compressor surges and maintain best specific fuel consumption. The FMU also prevents fuel flowing to the fuel spray nozzles in the event of an engine overspeed, and drains the fuel manifold into the drain tank on engine shutdown. The desired fuel flow is maintained by controlling the position of the fuel metering valve. A constant pressure drop is maintained across the fuel metering valve by the spill valve, which diverts unused fuel back to the fuel pump. The spill diverter valve allows spill return fuel to the FCOC at low engine speeds to prevent fuel from recirculating around the HP pump, which could cause excessive fuel temperatures. The high pressure shutoff valve (HPSOV) allows the fuel to enter the HP fuel filter and is controlled by the FMU and the engine run switches
- Fuel Flow Transmitter - Provides an indication of fuel flow to the EEC and to EICAS

5750 FF (PPH) 5750

GX\_17\_037

### NOTE

Can be displayed in pounds/hour (pph) or kilograms/hour (kph).

- HP Filter - Prevents debris from entering the fuel manifold and causing possible blockage of the fuel spray nozzles
- Fuel Temperature Transducers - Fuel enters the fuel filter and passes over the temperature transducers which relay the information to the EEC for the heat management system and displays the temperature on the FUEL synoptic

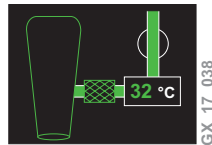

- Overspeed and Splitter Unit (OSU) - Splits the fuel flow equally between the lower and upper fuel manifolds. In the event of LP shaft breakage detection, the OSU has a fuel shutoff mechanism that will open an overspeed valve to allow fuel pressure to close the splitter valve
- Fuel Spray Nozzles - Deliver the metered fuel into the combustion chamber. The combination of HP air and narrow fuel orifice in the nozzle causes the fuel to be forced into a fine spray for maximum efficiency combustion
- Fuel Drain Tank - The fuel is drained from the fuel manifold after engine shutdown and is passed through a drain valve in the FMU to the drain tank. The drain tank delivers the fuel to the LP pump during the next engine run. The tank has an integral injector which uses LP pump delivery fuel as a motive force to empty the tank

**FUEL SYSTEM SCHEMATIC**

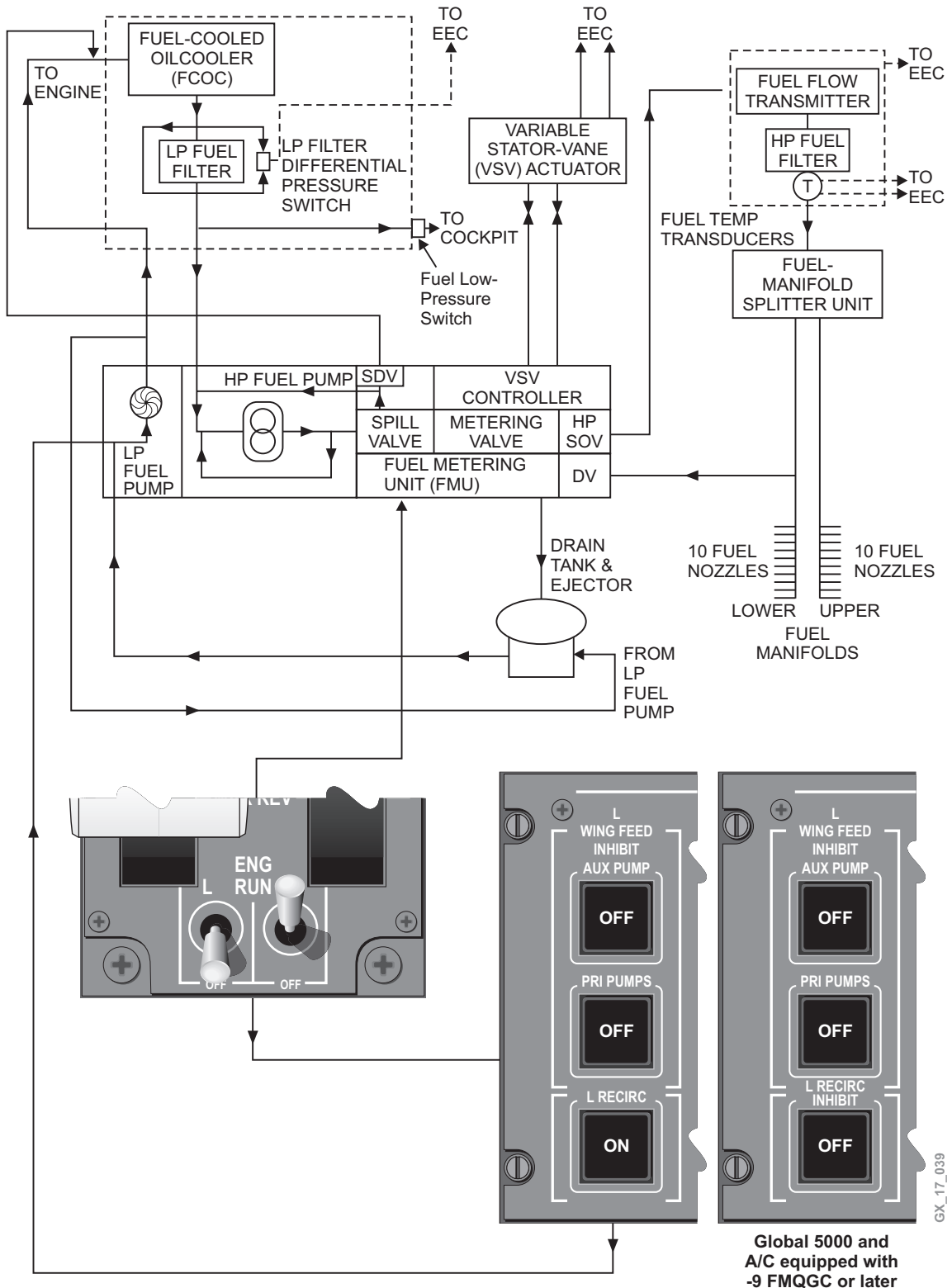

Global 5000 and A/C equipped with -9 FMQGC or later

GX\_17\_039

## ENGINE BLEED AIR SYSTEM

The pneumatic system supplies compressed air for air conditioning and pressurization, Ice and Rain Protection and Engine starting. The pneumatic air supply normally comes from the engines (inflight), and the APU or a high pressure ground air supply unit (on the ground).

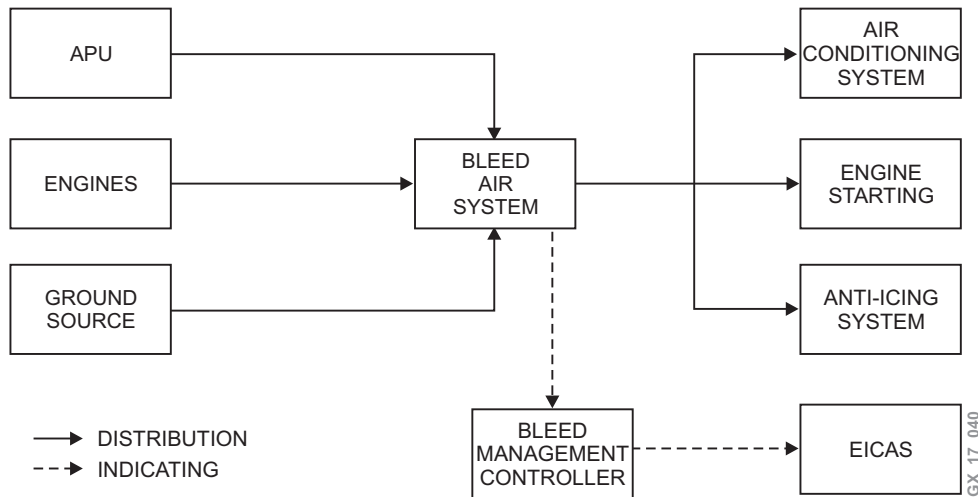

The engine bleed air system is controlled during all phases of operation by two Bleed Management Controllers (BMC).

The BMC selects air from either the low pressure port (5th stage of the high pressure compressor) or the high pressure port (8th stage of the high pressure compressor) depending on the demand. Under normal operation (inflight), the air is selected from the 5th stage of compression. When the airflow is insufficient, the BMC will select the 8th stage of compression.

L and R ENG BLEED AIR selection, AUTO or ON, is accomplished via the BLEED/AIR COND/ANTI-ICE panel on the overhead panel. A crossbleed valve (CBV) is installed between the left and right pneumatic ducts, which can be opened, automatically by the BMC or manually, to provide bleed air for engine starting. The APU is normal source of bleed air used for engine starting.



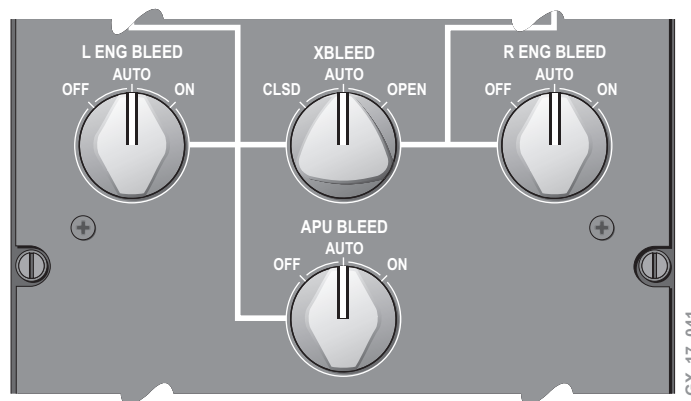

For more information on ECS, see chapter 13, Integrated Air Management System.

For more information on cowl and wing anti-icing, see chapter 3, Anti-Ice System.

## **THRUST MANAGEMENT SYSTEM**

### **THRUST LEVERS**

The thrust lever quadrant incorporates a main lever for setting forward thrust and reverse thrust, with a finger lift lever for thrust reverser operation, Takeoff/Go Around (TOGA) switches, autothrottle engage and disengage switches, quick disconnect and engine run switches.

Pressing the TOGA switches will change the pitch on the command bars on the PFD. For more information see chapter 2, AFCS.

The autothrottle is engaged by pressing the left or right engage/disengage switch(es). It is disengaged by a second press of either engage/disengage switch or by pressing either autothrottle quick disconnect button or by moving the thrust lever manually.

Selecting the ENGINE RUN switches to ON activates fuel pumps, opens the HPSOV in the fuel management unit and initiates the start sequence. Selecting the ENGINE RUN switches to OFF deactivates fuel pumps, closes the HPSOV and shuts down the engine.

Thrust lever movement transmits a signal to a dual channel RVDT. Each channel in the RVDT is dedicated to an EEC channel. The dedicated generator provides (through the EEC) the electrical power required for the RVDT to function. The EEC interprets the RVDT signal as a power demand and adjusts engine parameters accordingly. There is no mechanical linkage between thrust lever and engine.

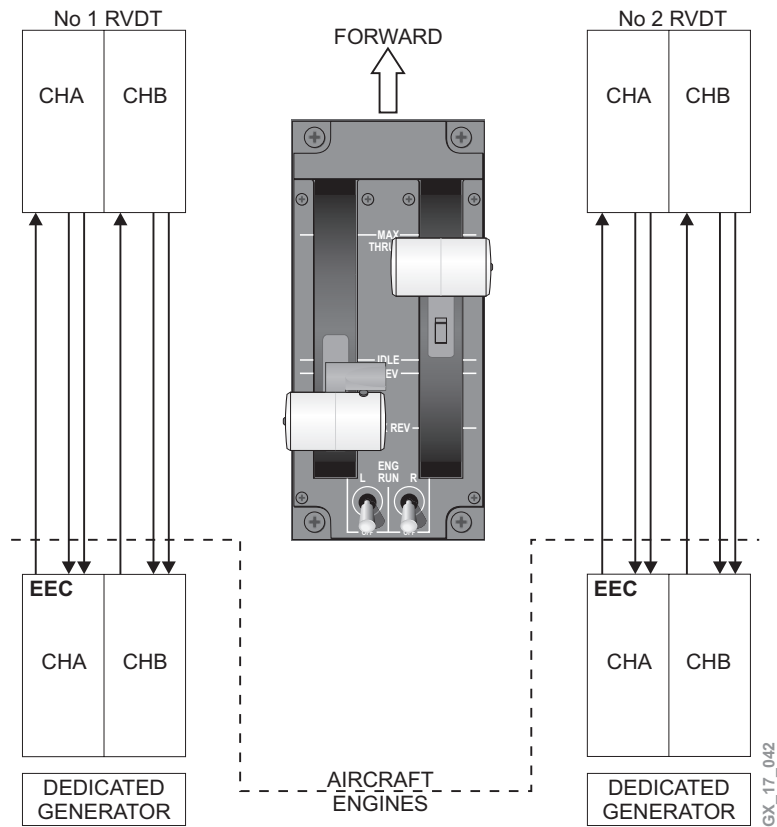

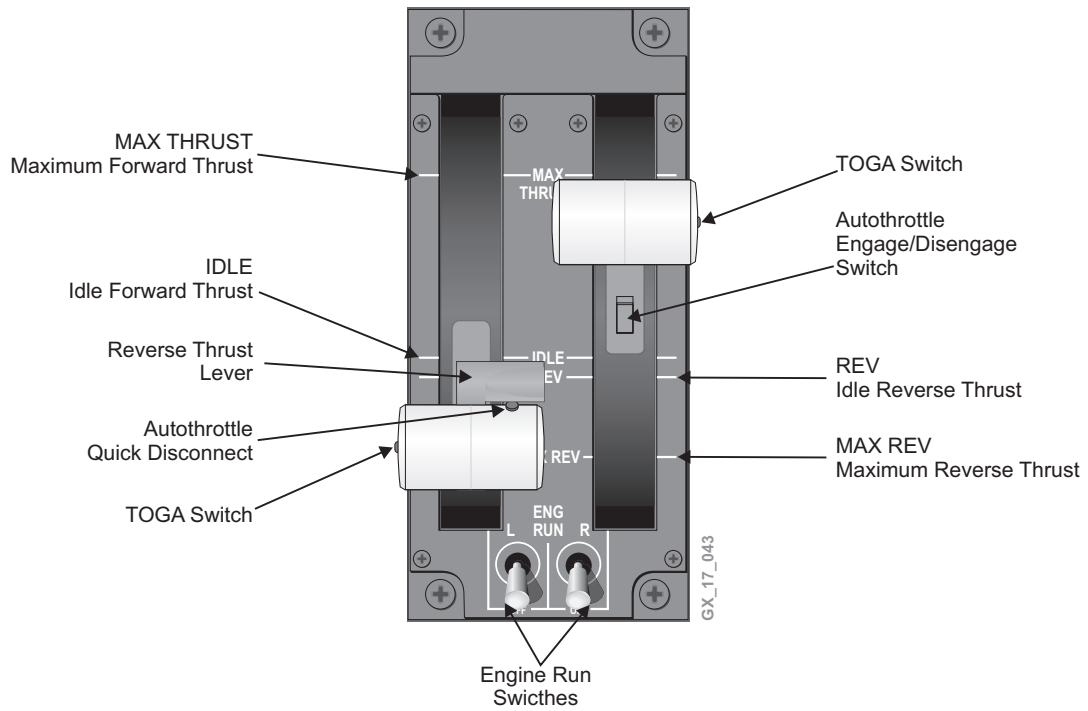
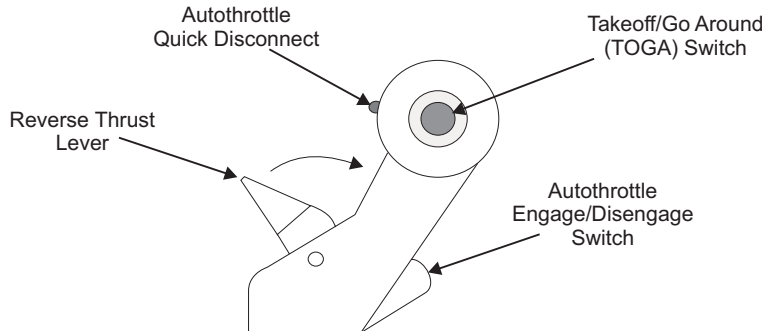

## ENGINE PRESSURE RATIO (EPR)

EPR is the primary control mode for thrust setting.

Raw EPR is calculated as a ratio of engine inlet total pressure and engine exhaust total pressure (P20 and P50) and then trims are applied to generate a fully trimmed EPR for engine control and display.

The engine inlet total pressure and temperature are sampled at the fan inlet. Engine inlet total pressure (P20/T20) is used by the EEC. P20 is used by the EEC for control functions and in the calculation of EPR and Mach number. Temperature sensor (T20) is used by the EEC for control function and for various EPR related functions.

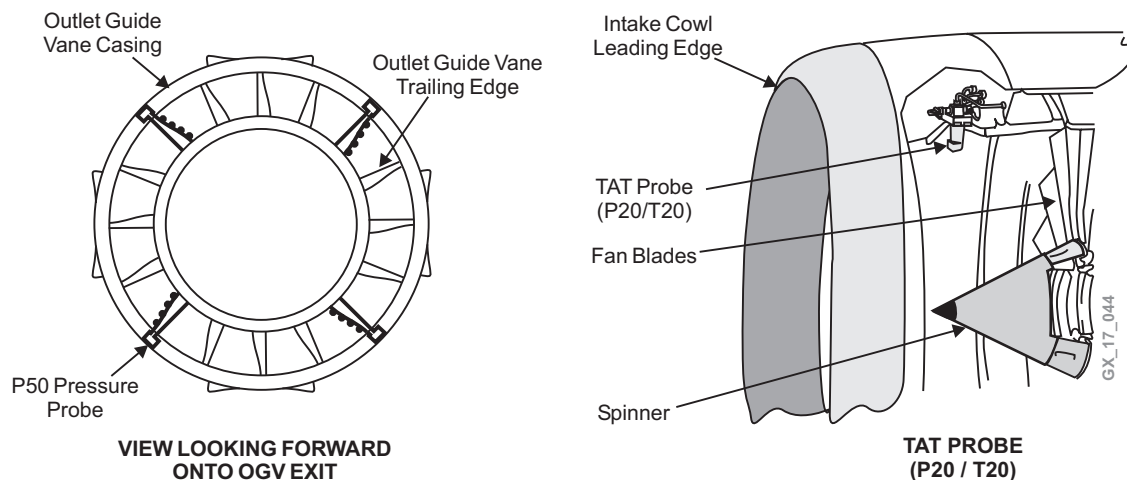

The core engine exhaust total pressure (P50), in combination with P20/T20, is also used by the EEC for EPR calculation. P50 air is sensed by four pressure probes, located on the outlet guide vane assembly. The pressure transducer within the EEC provides a signal to both channels of the EEC and is temperature compensated. The data entry plug ensures that both engines display the same EPR for the same actual engine thrust level.

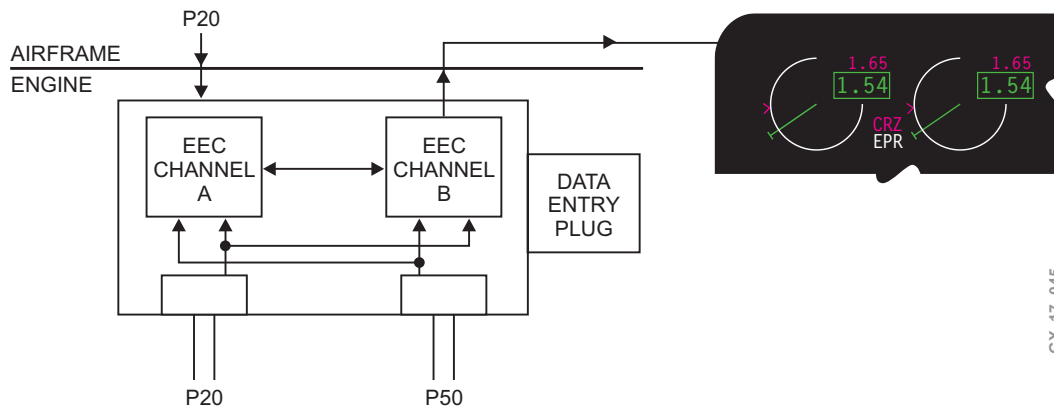

GX\_17\_045

## EPR RATING MODE SELECTION

EPR rating mode is automatically or manually set through the FMS PERF pages on the FMS. The following modes are available:

- **TAKEOFF (TO) Rating** - This rating is always set whenever the airplane is on the ground or whenever an engine failure is detected in flight. TO rating is limited to a maximum of 5 minutes (10 minutes in the event of an engine failure). Also, if AFCS mode is go-around or windshear, the rating is also automatically set to TO. The TO rating will remain until all of the following conditions are met:
  - The airplane is  $\geq 400$  feet above the runway
  - The flaps/slats are retracted
  - The pilot retards the thrust lever (Throttle Lever Angle (TLA)  $< 37^\circ$ ). This condition does not apply when autothrottle is engaged
- **Reduced Thrust Takeoff (FLX) Rating** - The FLX mode is permissible when the airplane weight and runway conditions are such that full TO rating is not required. FLX thrust is implemented by the use of an assumed temperature higher than ambient day temperature and is subject to the following:
  - The use of FLX thrust is limited to airport elevations below 10,000 feet MSL
  - The use of FLX thrust is at the pilot's discretion
  - Flex thrust does not result in any loss of function, failure warnings or takeoff configuration warnings
  - 75% of full rated thrust is used on all takeoffs
  - Manually advancing thrust levers to MAX THRUST changes the rating from FLX to TO
- **Climb (CLB) Rating** - After transition from TO or FLX to climb, the engine rating will stay in CLB until reaching the cruise altitude

- After reaching initial cruise altitude, the rating will go back to CLB if a new climb is performed (step climb)
- Cruise (CRZ) Rating - This rating will transition from CLB to CRZ after reaching the Top Of Climb (TOC) altitude and the airplane speed has reached cruise speed target within 1 knot or 0.005 Mach
- The rating will remain in CRZ as the airplane descends, until flaps/slats or gear are selected down, at which point the rating will return to TO
- Maximum Continuous Thrust (MCT) - This rating is valid:
  - When an engine is failed, the rating mode will transition out of TO and into MCT instead of CLB or CRZ
  - The rating will remain at MCT in the engine out condition, as long as the twin engine rating would have been CLB or CRZ
- Manual Engine Rating - Any rating (TO, CLB, MCT, CRZ) but FLEX can be selected on the FMS RATING Select page. This freezes the rating type

## FMS SELECTION (EPR)

To select EPR ratings on the FMS proceed as follows:

1. Press PERF function key and go to page 2/2 of the PERF INDEX.

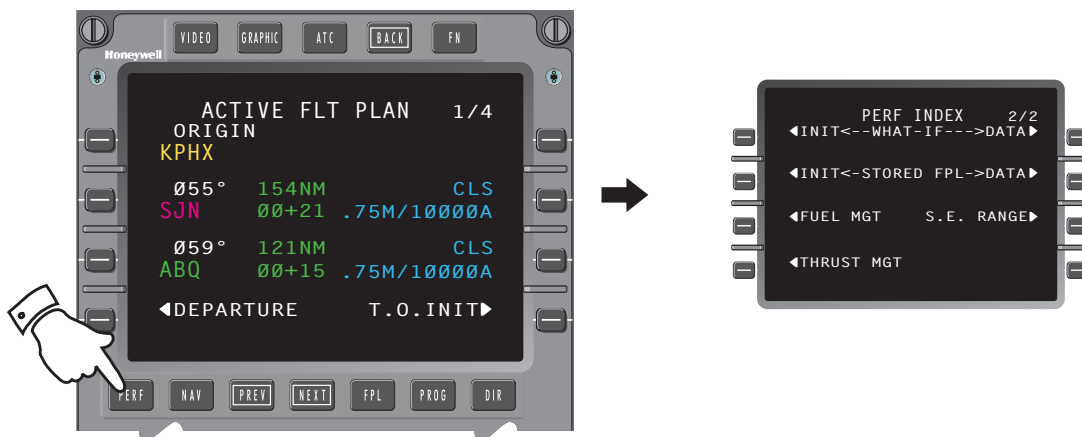

2. Select THRUST MGT line select key.

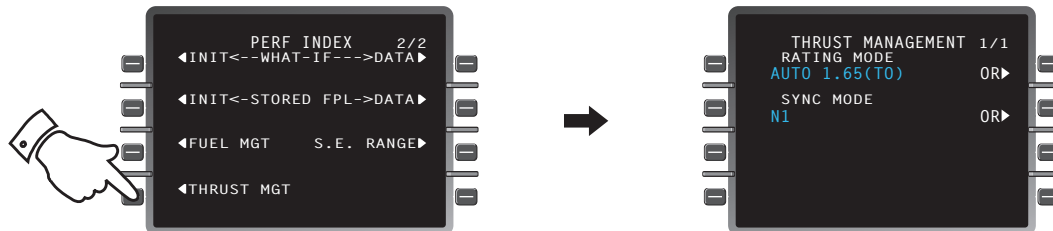

3. Select applicable OR line select key on RATING line and set as required.

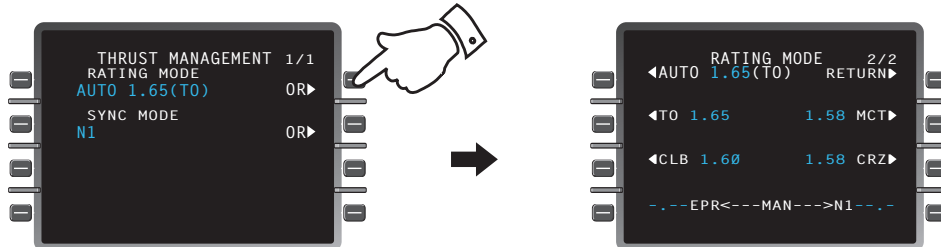

4. To select SYNC mode, select OR line select key on SYNC line and set as required.

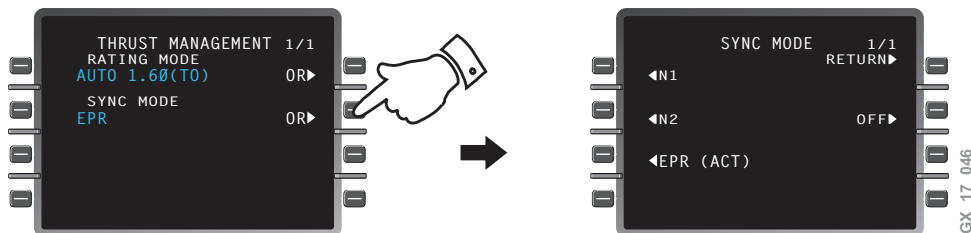

## EPR CONTROL

EPR control mode is selected on the engine control panel, located on the pedestal. Both EPR or N1 switches must be the same selection.

### Engine Switches

Used to select engine control mode:

- **N1** - selects engine control in alternate mode.
- **EPR** - selects engine control in primary mode.

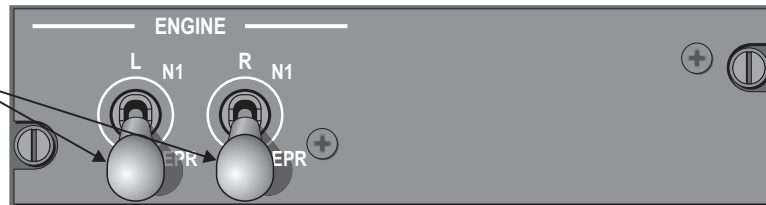

### EPR Sweep Arm

Displays the current EPR readout.

### EPR Rating "V" Bug

Displays the target EPR bug for the rating mode selected.

#### Note:

When the EPR readout and the EPR rating match, the bugs will blend.

### EPR Rating Mode

Displays thrust rating are selected automatically or manually.

The following rating modes are available:

- Takeoff (**TO**) mode
- Reduced Thrust Takeoff Mode (**FLX**)
- Climb Mode (**CLB**)
- Cruise Mode (**CRZ**)
- Maximum Continuous Thrust Mode (**MCT**)
- Manual Mode (**MAN**).

#### Note:

If the EPR rating mode is MAN, the mode, rating readout and rating V bug will be cyan.

### EPR Rating Readout

Displays the EPR readout for the mode selected.

### EPR Readout

Displays the current EPR readout.

### Engine Control Mode Box

Displayed when in EPR control mode.

### EPR "T" Readout Bug

Displays the current EPR command bug (throttle position)

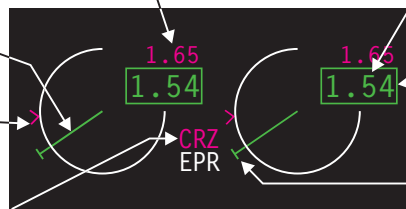



### N1 (FAN)

The N1 LP compressor (fan) speed is used as the alternate engine control. The N1 signals are used by the EEC for engine control functions and are used by the Engine Vibration Monitor Unit (EVMU).

N1 is measured by four speed probes per engine, mounted on the front bearing housing.

Three speed probes are used by the EEC for the following:

- N1 EICAS indication
- N1 redline limiting
- N1 rating control
- Thrust control (reverse thrust)
- Independent Overspeed Protection (IOP) at 111.0% N1 speed

The fourth probe is used by the EVM system for engine vibration indication.

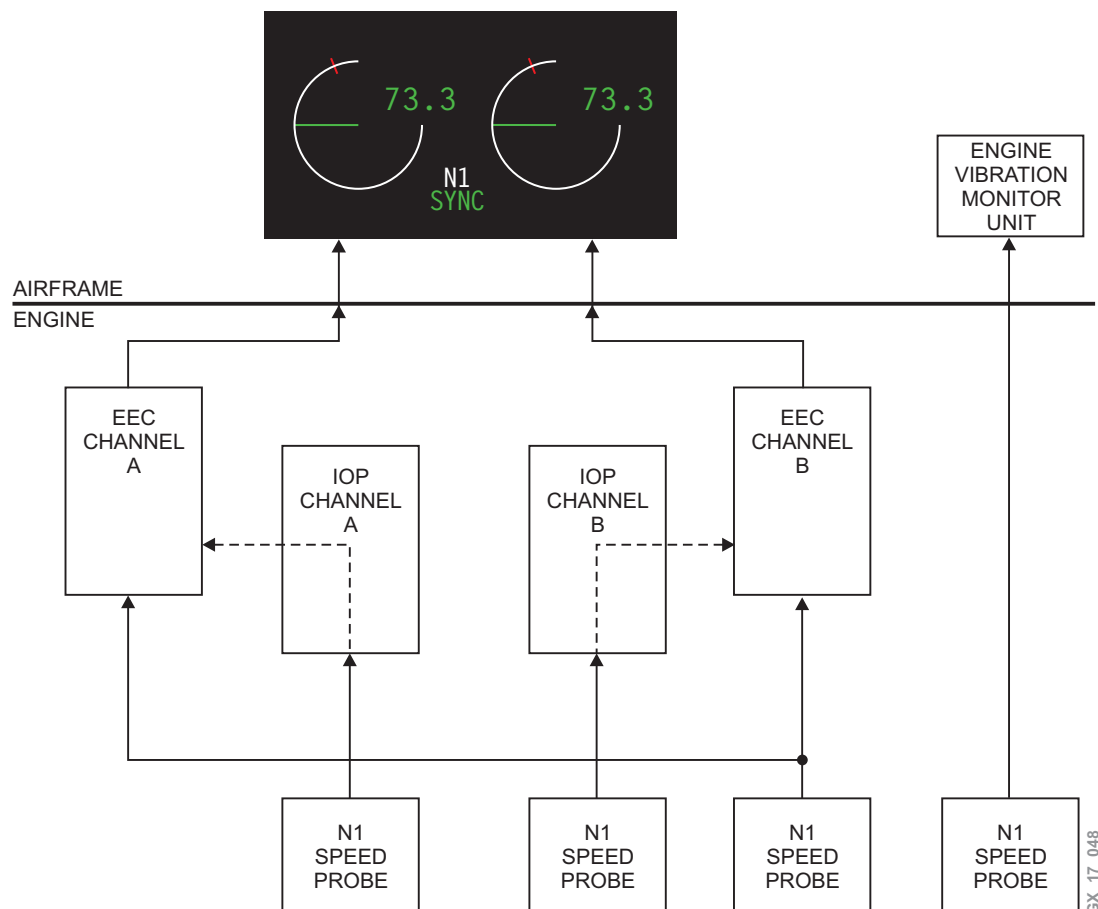

## N1 CONTROL

N1 control mode is selected on the engine control panel, located on the pedestal. Both switches must be in the same position. N1 can also be selected automatically by the EEC in the event of an EPR control mode failure. A reversion done by EEC is known as a soft reversion. As per QRH, both switches should then be selected to N1. A manual reversion is known as a hard reversion. An amber EICAS message will be displayed when a failure is detected and a status message will be displayed, when the control switches have been selected to N1 control manually.

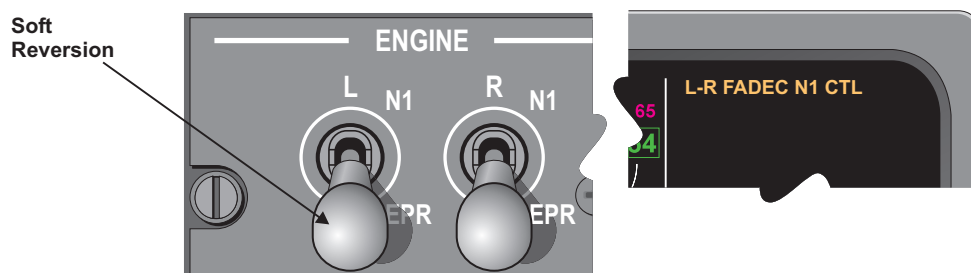

**NOTE:**  
Before manually reverting to N1 control, the thrust levers should be retarded to avoid thrust "bumps".

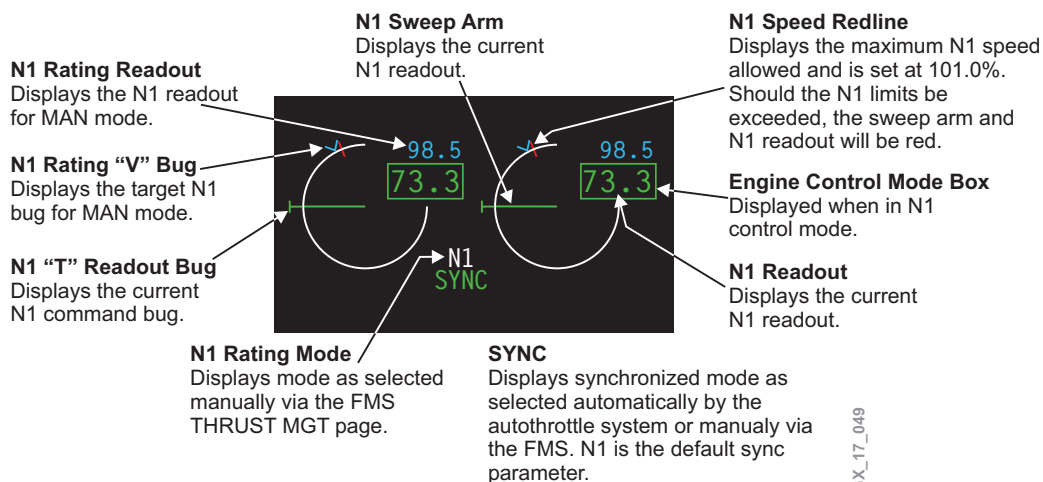

## NOTE

When the N1 readout and the N1 rating match, the bugs will blend.

## N2 (HP COMPRESSOR)

The N2 signals are used by the EEC for engine control functions and are used by the Engine Vibration Monitor Unit (EVMU).

N2 is measured by four speed probes per engine, mounted in the accessory gearbox. Three speed probes are used by the EEC for the following:

- Variable stator vane control
- Bleed valve control
- Start/relight
- Redline limiting
- Idle control
- Surge protection/recovery
- Overspeed protection
- N2 EICAS indication

The fourth probe is used by the EVM system for engine vibration indication.

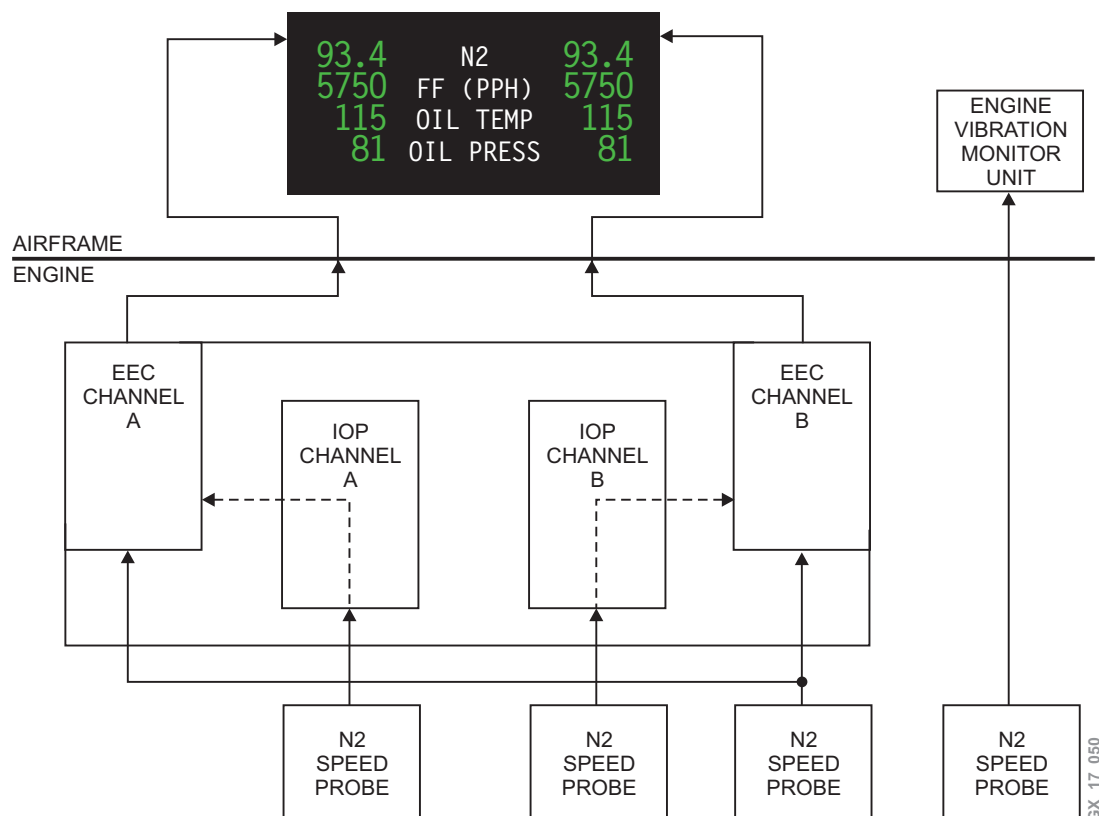

## **ENGINE IDLE CONTROL**

The EEC uses one of two modes to set steady state power above idle, EPR or N1 mode. Although idle is controlled to a RPM value, an equivalent EPR is also calculated so that the EEC can establish a Throttle RVDT Angle (TRA) to EPR relationship throughout the operating range.

The EEC will control idle to prevent the engine from operating below minimum limits to:

- Ensure that cabin bleed demands are met
- Ensure cowl anti-ice demands are met on the ground or inflight
- Ensure that the variable frequency generators stay on line
- Protect against inclement weather by opening bleed valves to aid rejection of water and maintain the surge margin, commanding continuous ignition to maintain combustion, as well as increasing engine speed by an appropriate margin

Low idle range is commanded when in the forward idle position and the airplane is not in an approach configuration.

High idle is commanded when in the forward idle position and the airplane is in an approach configuration.

If the EEC cannot determine whether or not an approach configuration has been set up, then the EEC will default to high idle.

Forward thrust is set by positioning the thrust levers manually or automatically. Reverse thrust is a manual selection only.

**ENGINE FIRE DETECTION SYSTEM**

Engine fire detection is provided by a dual-loop system, each loop consisting of sensing elements. Each zone's elements are mounted on support tubes.

The Fire Detection and Extinguishing (FIDEEX) system provides fire detection and extinguishing to both main engine zones.

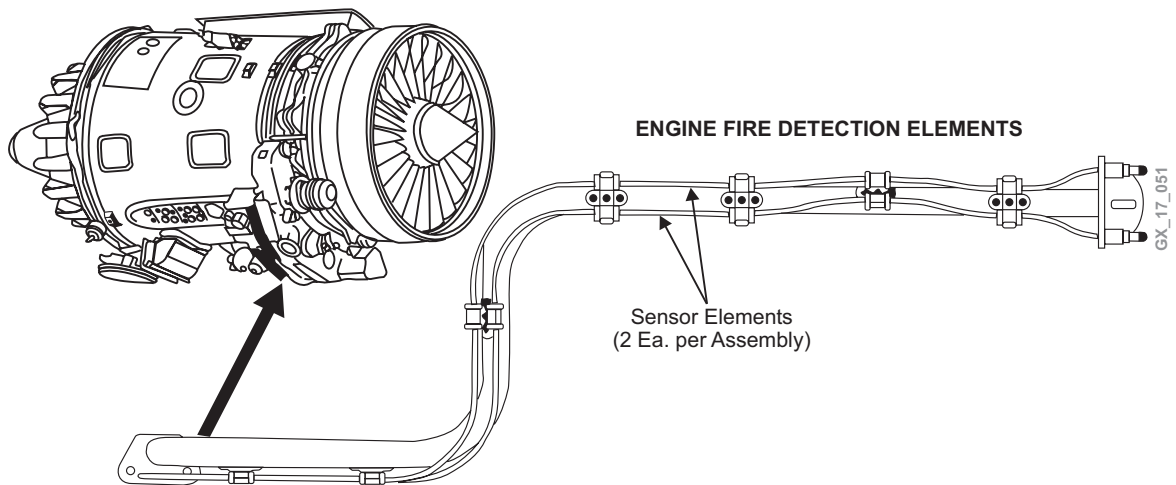

The detection loops of both zones are monitored as a single zone, and the fire extinguishing system when discharged, supplies both zones simultaneously.

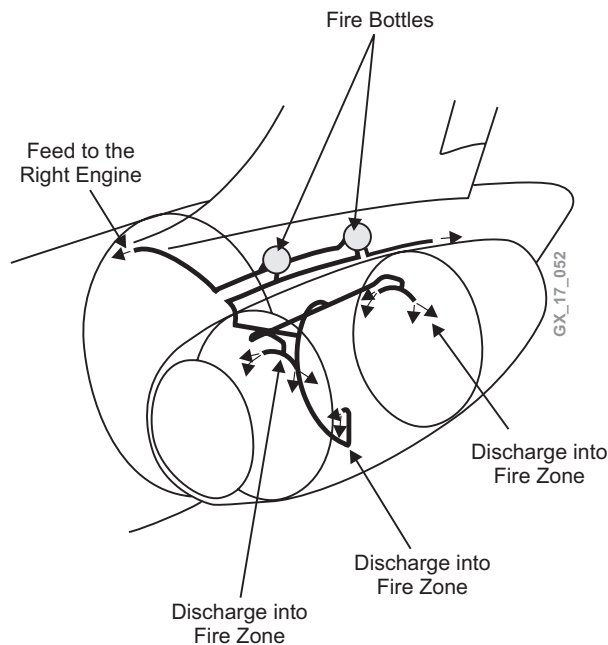

For more information, please see chapter 9, Fire Protection.

## ENGINE VIBRATION MONITORING SYSTEM (EVMS)

The EVMS provides the crew with a means of continuously monitoring any imbalance of the rotating assemblies, N1 and N2. The EVMS is a stand alone system, independent of FADEC.

The system comprises one airframe-mounted Engine Vibration Monitoring Unit (EVMU) that processes signals from dedicated N1 and N2 speed probes and vibration transducers. The EVMU provides indication of engine vibration on EICAS.

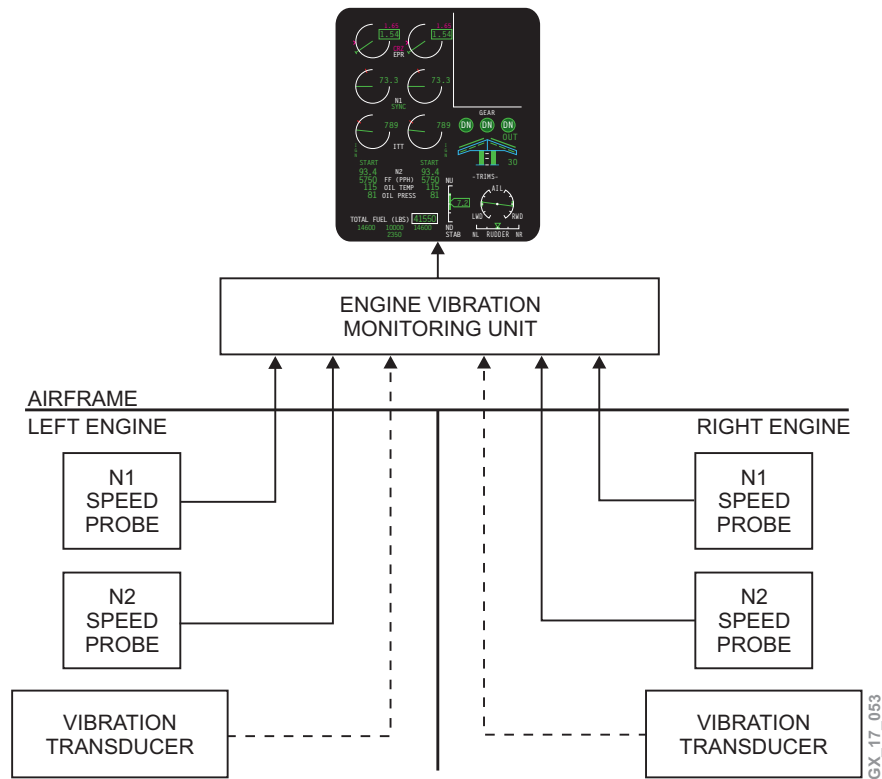

## EVMS INDICATION

VIB	N2	VIB
93.4		93.4
5750	FF (PPH)	5750
115	OIL TEMP	115
81	OIL PRESS	81

### N2 VIB Indication

If the N2 vibration monitor readings are greater than 1.0 in/sec then the **VIB** icon is displayed.

93.4	N2	93.4
5750	FF (PPH)	5750
115	OIL TEMP	115
81	OIL PRESS	81
0.5	N1 VIB	1.1

### N1 VIB Indication

1. If the N1 vibration monitor readings are less than 0.5 in/sec, then the N1 VIB will not be displayed.
2. However, anytime VIB above N2 is displayed then N1 VIB is displayed.
3. N1 VIB indications above 1.0 in/sec turn amber.

**STARTING AND IGNITION**

The engine starting system consists of the Starter Air Valve (SAV), interfacing with the EEC, and the Air Turbine Starter (ATS). Pneumatic bleed air is routed through the SAV and drives the ATS, which in turn drives the HP compressor via the accessory gearbox.

The EEC receives start commands from the cockpit. SAV position is fed to both EEC lanes and is powered by 28 VDC.

The EEC also controls both high energy igniter boxes for starting and relighting and the ignition system is powered by 28 VDC.

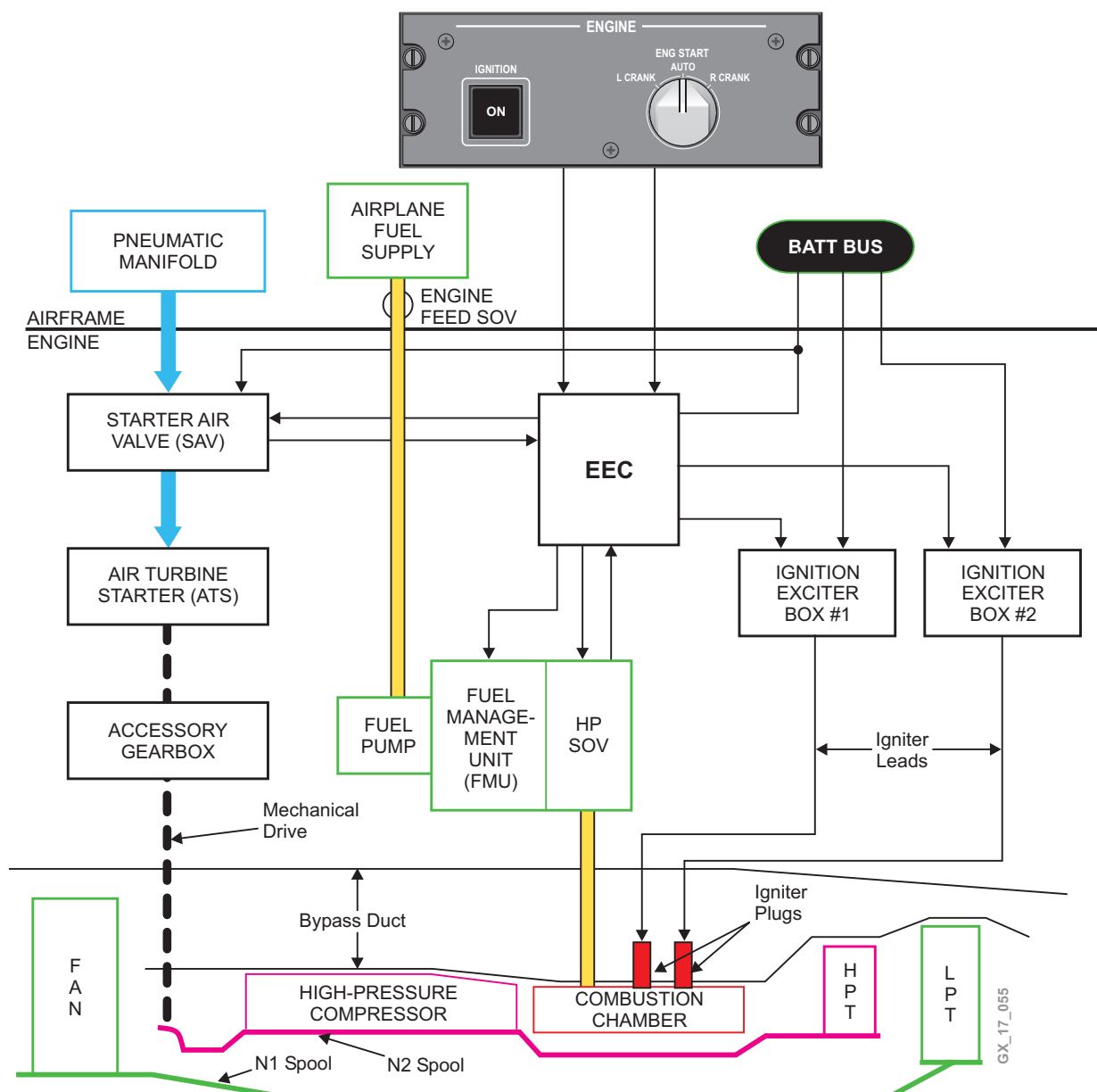

## STARTER AIR VALVE (SAV)

The SAV controls the air supply to the starter motor. The SAV is controlled by either channel of the EEC from crew input.

During AUTO ground starts the EEC will, on command from the crew, open the SAV, initiate engine rotation, supply fuel and ignition and monitor engine parameters during start. The EEC will also close the SAV, disengage the starter motor and switch off ignition at starter cutout speed.

During manual ground starts, opening and closing of the SAV and HPSOV is controlled by the crew. The EEC will control ignition sequencing, after ignition is enabled by the crew.

The SAV can also be operated manually, by ground personnel, in the event of a valve failure. The SAV is displayed on the BLEED/Aнти-ICE synoptic, anytime an engine is not operating.

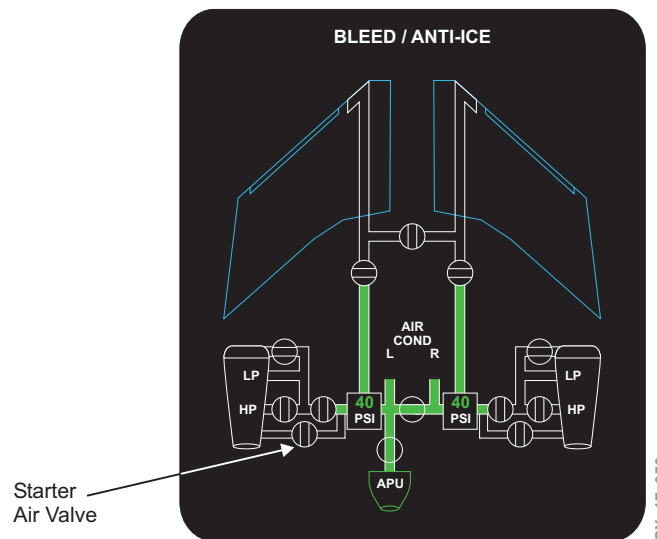

## AIR TURBINE STARTER (ATS)

The ATS rotates the HP compressor to enable engine start.

The ATS comprises a single-stage turbine, a tungsten cutter (to cut off turbine, if rotor bearings fail), a sprag-type clutch, an output drive shaft decoupler (prevents driving the turbine, in the event the sprag clutch seizes) and an output drive shaft shear neck (protects the gearbox, in the event the starter overtorques or seizes).

At starter cutout speed, the SAV is closed, the turbine loses speed, which disengages the sprag clutch.



The START message is displayed on EICAS and on the BLEED/Anti-ICE synoptic page.

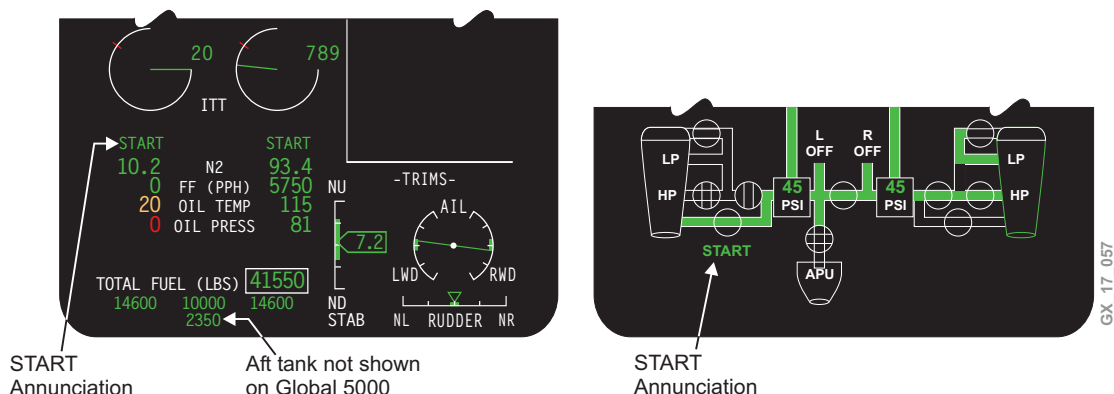

## IGNITION SYSTEM

The ignition system ignites the fuel/air mixture in the combustion chamber, as commanded by either of the two channels of the EEC, during the start sequence and to maintain combustion during critical phases of flight (stall).

The ignition system comprises two exciter boxes, two igniter leads and two igniter plugs. Power is supplied from 28 VDC and is controlled from channel A or B in the EEC.

For consecutive ground start attempts the EEC alternates channels and igniters as follows:

- EEC channel A                      Igniter 1
- EEC channel B                      Igniter 1
- EEC channel A                      Igniter 2
- EEC channel B                      Igniter 2

The above only applies if there are no failures within the FADEC, which prevents alternate selection.

In the event that the ground start (AUTO) has been aborted, the EEC will automatically select the other igniter on the following ground start.

During air starts (AUTO), the EEC will select both igniter channels.

During manual ground and air starts, the EEC will select both igniters, as commanded by the IGNITION switch.

The crew can manually select the ignition system energized continuously on the ENGINE panel, located on the overhead panel. Upon selection of the ignition switch, the EEC will energize the igniter unit, on an operating engine. Crew selection of ignition is not time limited, but will reduce overall igniter life.

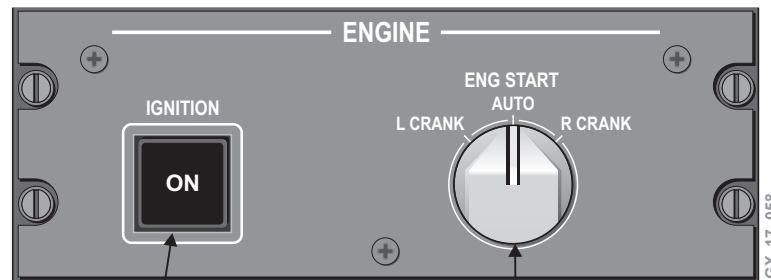

**IGNITION Select Switch**  
Used to select all 4 igniters (2 per engine).  
**Normal** (dark) - Default mode of operation. The EEC controls ignition.  
**ON** (illuminated) - Indicates that the switch has been selected ON and igniters are firing continuously.

**ENGINE START Selector**  
Used to start both engines.  
**AUTO** - Selects automatic starts for either engine.  
**L-R CRANK** - Initiates rotation of the left or right engine for dry or wet cranking or manual start.

### NOTE

There is a timed out limit (30 seconds), for igniter operation on the ground (with engines not operating), for maintenance purposes.

An EICAS message is displayed when IGNITION is selected ON.



## ENGINE RUN SWITCHES

The ENGINE RUN switch(es), when selected by the crew to either the ON or OFF position, will inhibit or allow the EEC to control the engine. The switch(es) interface(s) with both EEC and the HP Shut Off Valve (HPSOV) to:

- Manually control closing and opening of the HPSOV
- Indicate to the EEC the Engine Run switch position and perform a dual channel reset and to close the HPSOV in the Fuel Management Unit (FMU)

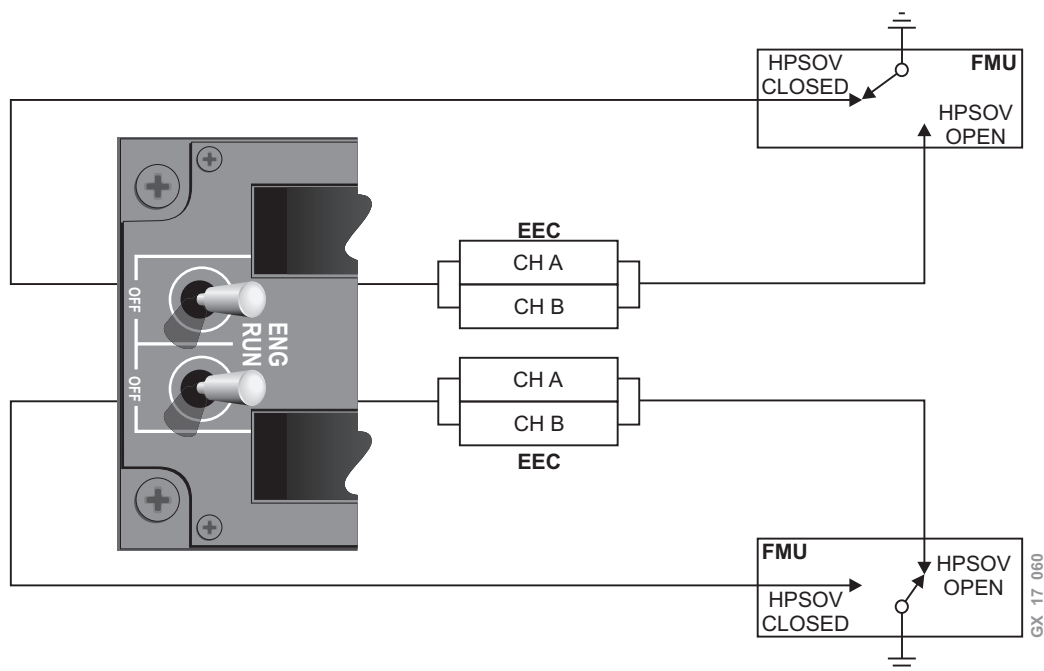

The Engine Run switch controls the respective HPSOV. The switch in the ON position enables the HPSOV open and the switch in the OFF position enables the HPSOV closed.

The Engine Run switch in the ON position gives EEC authority to open HPSOV during an automatic ground or air start. When the switch is set to the OFF position, the HPSOV will close.

The Engine Run switch in the ON position will directly command the EEC to open the HPSOV during a manual ground or air start. When the switch is set to the OFF position, the HPSOV will close.

The EEC will override an Engine Run Switch ON command by closing the HPSOV only for an automatic start abort or relight abort, or in the case of an overspeed.

The transition ON to OFF initiates a reset of both lanes of the EEC of the associated engine and will also send a signal to command the starter air valve to close.

**ENGINE STARTING**

**AUTO START - GROUND**

The normal start sequence is initiated automatically, with the ENGINE START switch selected to AUTO, IGNITION switch selected to Normal (default), thrust levers IDLE and the engine RUN switch to ON. The APU is the normal source of air during ground start.

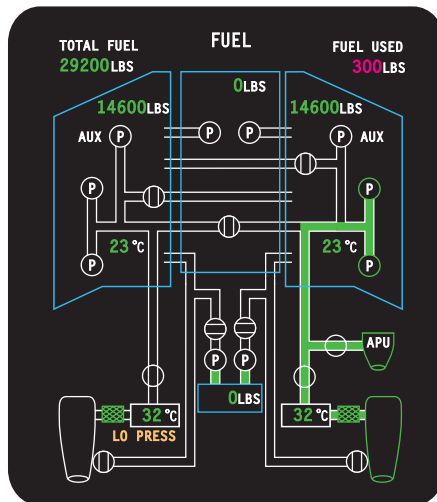
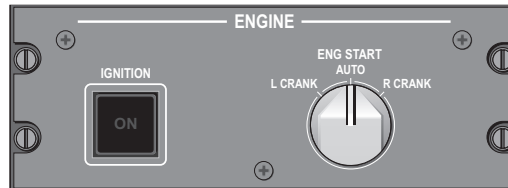
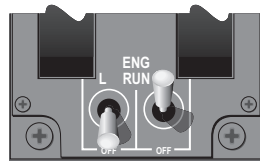

**GLOBAL EXPRESS FUEL SYNOPSIS**

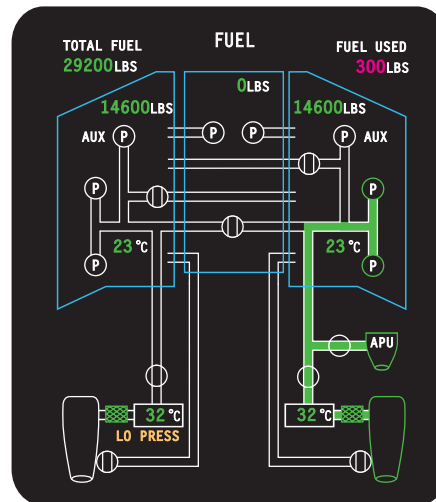

**GLOBAL 5000 FUEL SYNOPSIS**

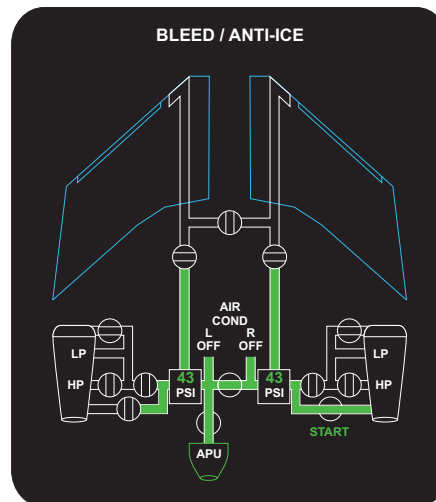
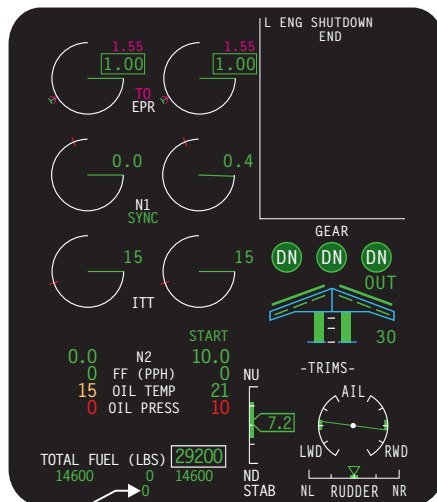

GX\_17\_061

No aft tank on Global 5000

**Note:**  
The engine data quoted in this example are approximate values.

At approximately 15% N2, the ignition sequence occurs.

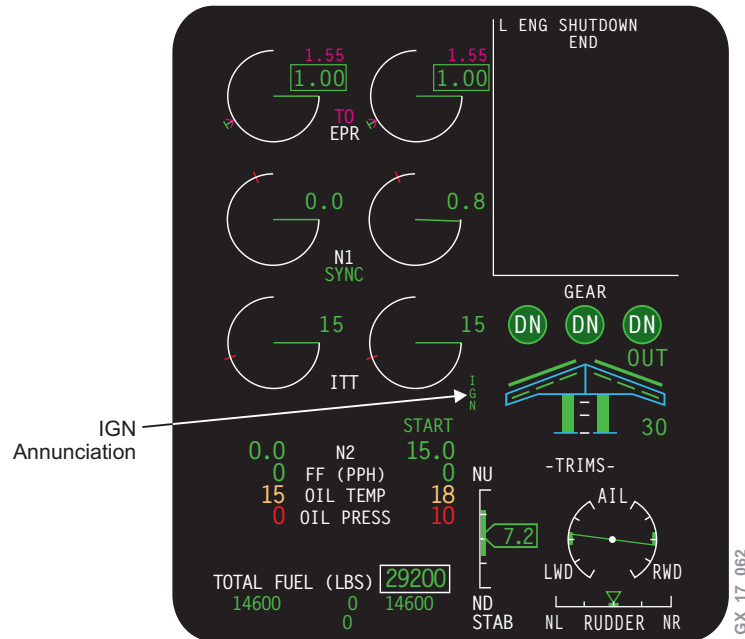

At approximately 15% N2 the igniters are turned on, at 20% fuel flow occurs and at approximately 25% N2 light-off occurs.

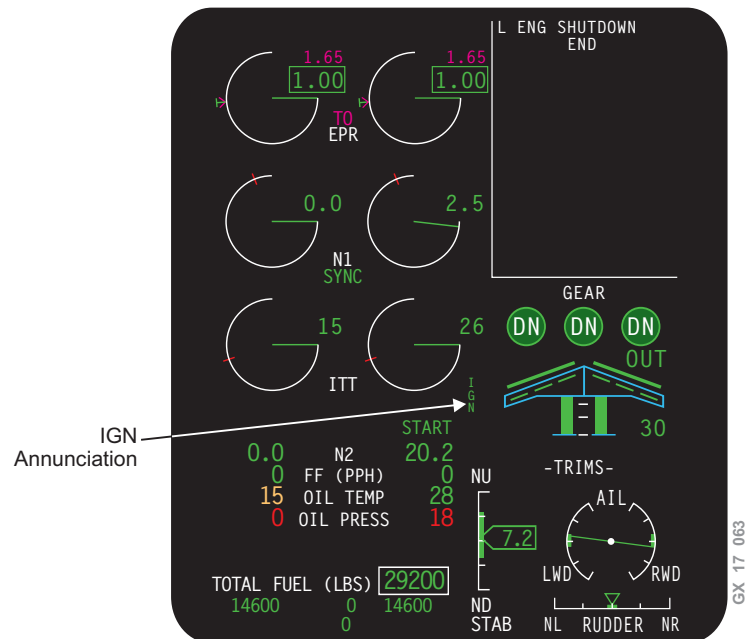

**NOTE**

The engine data quoted in this example are approximate values.

At approximately 42% N2, IGN off and at approximately 45% N2 START off (SAV closed).

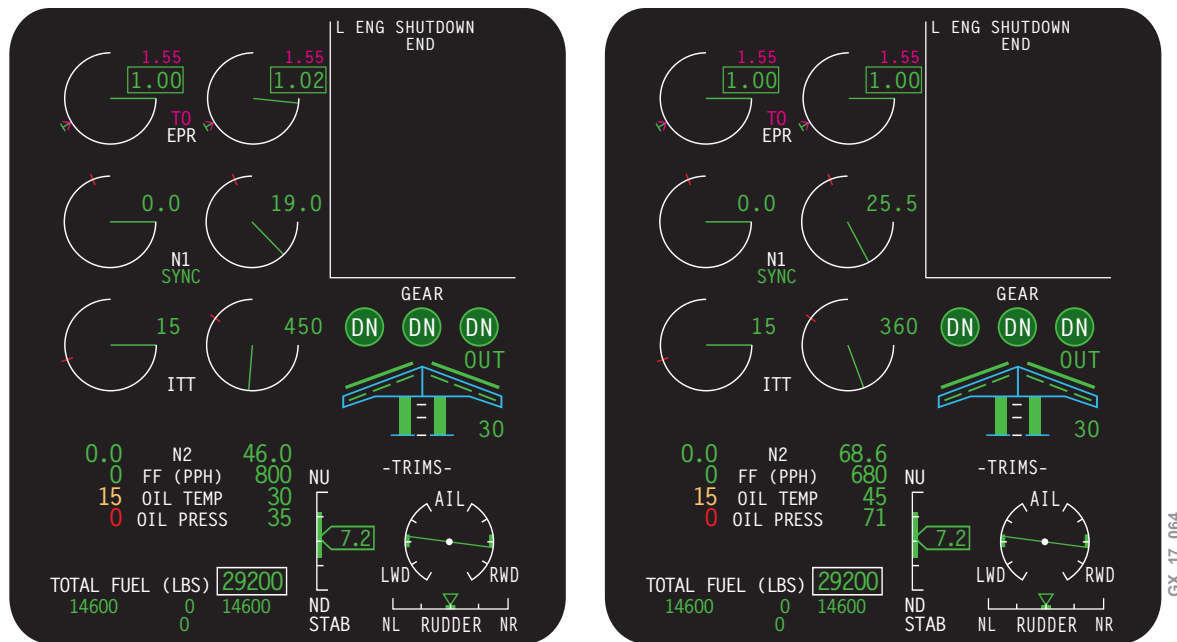

During an automatic start the EEC will perform all checks for starting anomalies. If a fault is detected, (hot start, hung start, etc.) the EEC will abort the start. The crew can stop the start sequence anytime by selecting the ENGINE RUN switch to OFF.

## ROTOR BOW

If the BR710A-20 engine is to be started between 20 minutes and 5 hours after the previous shutdown, there is a high potential for high core vibration during the next start. This is known as “Rotor Bow”, which occurs due to differential cooling of the high-pressure spool and subsequent distortions of the rotating assembly.

In all manual ground starts, the operator must carry out an Extended Dry Crank (EDC) procedure, consisting of motoring the engine prior to start, for a period of 30 seconds at the maximum motoring speed achievable.

However, during all automatic starts, the FADEC will determine if the EDC procedure is required and carry it out automatically. In both manual and automatic starts, it is permissible to continue the starting operation immediately following the EDC procedure, without performing a spool down of the engine.

## AUTO START - AIR

The EEC will determine if an ATS ENVELOPE ( $\leq 249$  knots) or a WINDMILL ENVELOPE ( $\geq 250$  knots) will be performed. The type of start will be displayed on EICAS.

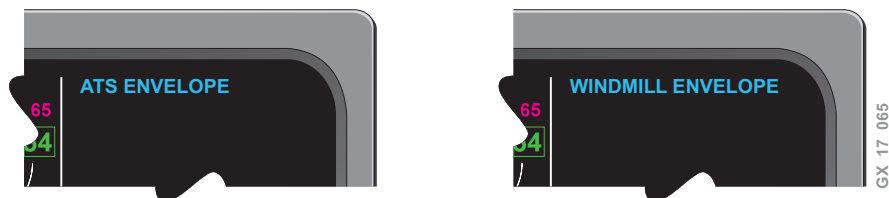

The air start sequence is initiated with the ENGINE START switch selected to RUN.

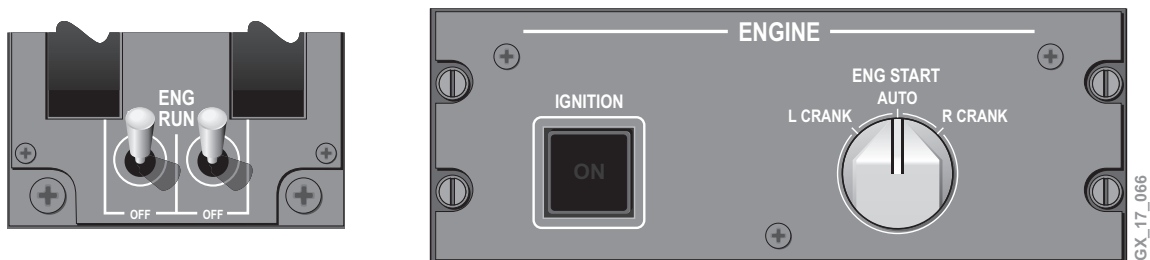

If ATS ENVELOPE (starter assisted air start) has been selected, the EEC will select the SAV open, activate the starter motor, if N2 is below starter reengagement speed (up to 42% N2).

If WINDMILL ENVELOPE has been selected, the EEC will not select the SAV open.

The EEC will activate ignition immediately and open the HPSOV if N2  $\geq 8\%$ . At approximately 45% N2, IGN will deactivate.

During an automatic start the EEC will perform all checks for starting anomalies. If a fault is detected, the EEC will abort the start (EEC will not abort an airborne relight, for hot starts). The crew can stop the start sequence anytime, by selecting the ENGINE RUN switch to OFF.

## MANUAL START - GROUND

The manual ground start sequence is as follows:

- Crew selects IGNITION switch ON

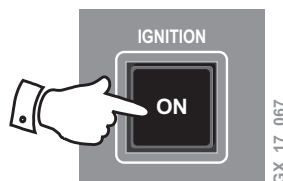

- Crew selects the START SELECT switch to CRANK for the appropriate engine

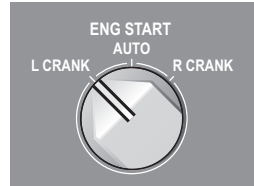

**Note:**  
The engine data quoted in this example are approximate values.

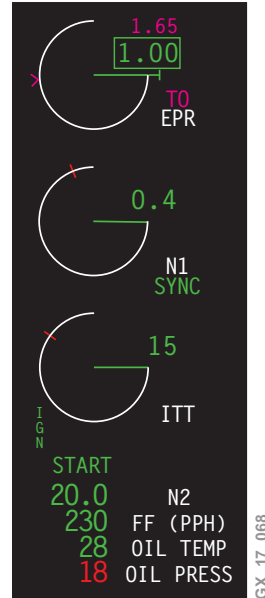

- At 20% N2, crew selects the ENGINE RUN SWITCH to ON. Fuel flow and light off occur

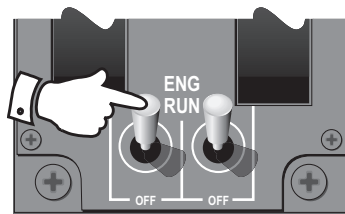

**Note:**  
The EEC does not protect the engine from overtemp or any start anomalies during a manual start.

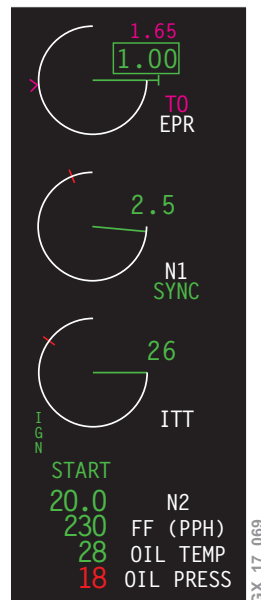

- At approximately 45% N2, SAV closes automatically



During manual start, the EEC will not limit ITT, the crew has to abort the start in case of starting anomalies. After completion of the manual start sequence, the crew select IGNITION to Normal and returns the START SELECT switch to AUTO.

## ENGINE SHUTDOWN

The normal engine shutdown sequence is as follows:

- Place thrust lever in Idle position

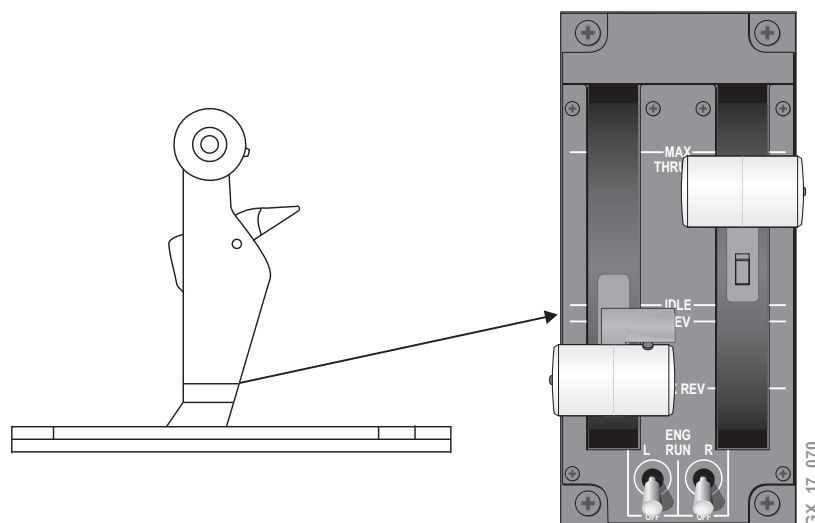

- Place ENGINE RUN switch to the OFF position, when engine has stabilized at Idle. Normal procedure is to stabilize engine at Idle for a 3-minute period

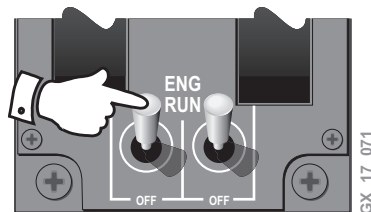

The EEC will reset (in preparation for the next engine start) after ENGINE RUN switch has been selected to OFF.

## DRY CRANKING

Dry cranking of the engine is accomplished as follows:

- Ensure ENGINE RUN switch is selected to OFF
- Ensure IGNITION switch is Normal (the EEC will inhibit IGNITION when CRANK is selected, unless IGNITION has been selected to ON)
- Select START SELECTOR to L CRANK or R CRANK

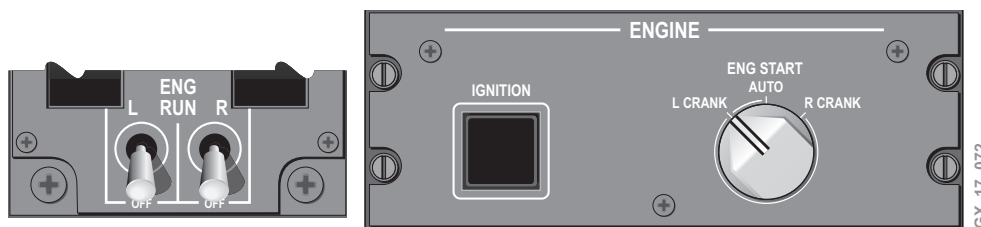

The EEC will open the SAV and activate the starter motor (if N2 below starter reengagement speed). The EEC will keep the starter motor operating as long as the N2 is below starter disengagement speed (approximately 45% N2), for 3 minutes maximum.

The crew can stop cranking by selecting START SELECTOR to AUTO.

## WET CRANKING

Wet cranking is normally performed by maintenance personnel.

Wet cranking of the engine is accomplished as follows:

- Ensure IGNITION switch is Normal (the EEC will inhibit IGNITION when CRANK is selected, unless IGNITION has been selected to ON)
- Select START SELECTOR to L CRANK or R CRANK
- Select ENGINE RUN switch to ON (HPSOV opens allowing fuel to the engine burners)

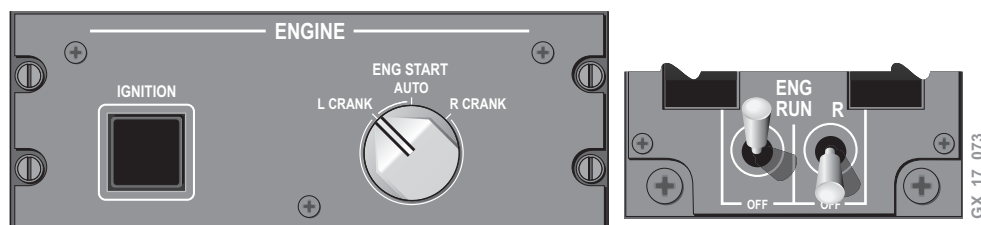

The EEC will open the SAV and activate the starter motor (if N2 below starter reengagement speed). The EEC will keep the starter motor operating as long as the N2 is below starter disengagement speed (approximately 45% N2), for 3 minutes maximum.

## **STARTING ANOMALIES**

### **AUTOMATIC GROUND START ABORT**

Any of the following events will result in an automatic ground start abort:

- Crew selecting ENGINE RUN switch to OFF
- N2 speed not greater than or equal to 15% (120 seconds from ENGINE RUN switch ON)
- Idle speed not achieved (120 seconds from HPSOV open)
- Starter cutout not being reached within starter duty timer (180 seconds from SAV open)
- ITT exceeding the ground start limit (700°C) after light-off and during acceleration to Idle

### **MANUAL GROUND START ABORT**

Any of the following events will result in a manual ground start abort:

- Crew selecting ENGINE RUN switch to OFF
- Crew selecting the START SELECTOR switch to AUTO
- Crew selecting the IGNITION switch to Normal

### **AUTOMATIC AIR START ABORT**

Any of the following events will result in an automatic air start abort:

- Crew selecting ENGINE RUN switch to OFF
- N2 speed not greater than or equal to 15% (60 seconds from ENGINE RUN switch ON)
- Idle speed not achieved (600 seconds from HPSOV open)
- Starter cutout not being reached within inflight starter duty timer (180 seconds from SAV open)

## AUTO-RELIGHT

The EEC provides an Auto-Relight function to detect and recover an engine flameout. The Auto-Relight function is enabled when the engine is at or above Idle and the ENGINE RUN switch is ON.

Two methods are used to detect a flameout at all engine speeds at or above Idle:

- By monitoring the rate of change of N2. The threshold for the rate of change is calculated as a function of HP compressor pressure exit (P30) and altitude. A flameout is assumed to have occurred if N2 decelerates at a rate greater than this threshold
- By monitoring the difference between commanded Idle N2 and actual N2. If the difference is greater than a preset threshold, a flameout is assumed to have occurred. This method is suppressed for 15 seconds, following a transition from low idle to high idle

When a flameout is detected, the EEC will energize both igniters and schedule fuel flow until the engine relights. The igniters are energized for 20 seconds after an engine relight.

If the engine continues to run down (no relight), then the EEC will close the HPSOV at 35% N2 and deenergize the igniters and an EICAS message is posted.

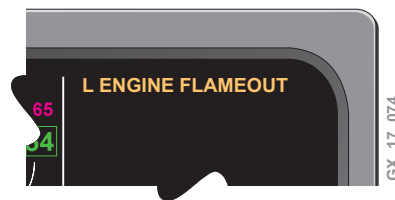

## QUICK RELIGHT

The EEC provides a Quick Relight function which automatically relights the engine if the ENGINE RUN switch has been momentarily selected to OFF then reselected to ON.

The Quick Relight functionality is defined as follows:

- Enabled only if in-flight
- Activated when ENGINE RUN switch is reselected ON within 30 seconds after selecting ENGINE RUN switch to OFF and N2 greater than or equal to Idle (42% N2)
- When Quick Relight activated, fuel is commanded ON and both ignition systems ON

If N2 continues to fall below Idle speed, Quick Relight will maintain both the ignition systems and fuel ON until the engine speed is regained for up to 20 seconds.

The crew can cancel Quick Relight by selecting the ENGINE RUN back to OFF.

## **AUTOTHROTTLE SYSTEM**

The autothrottle system performs the following functions:

- Operation over the full range of available forward thrust for two engine operation. The autothrottle will not operate under single engine conditions
- Hands-off operation from takeoff to landing
- Engine synchronization
- Electronic Thrust Trim System (ETTS)

The A/T has two basic modes of operation:

1. Thrust control for the following AP/FD modes:
  - T/O (Takeoff)
  - GA (Go Around)
  - WS (Windshear)
  - FLC (Flight Level Change)
2. Speed control
  - For all other Flight Director modes

Note that the default operation for the A/T is speed control when no AP/FD modes are active.

### **AUTOTHROTTLE (A/T) DATA SOURCES**

The A/T selects the IRS displayed on the coupled PFD as the IRS source during non-dual coupled AP/FD operation. During dual coupled AP/FD operation A/T selects the IRS displayed on each PFD and averages the data.

The A/T selects the ADC displayed on the coupled PFD as the ADC source during non-dual coupled Autopilot/Flight Director (AP/FD) operation. During dual coupled AP/FD operation A/T selects the ADC displayed on each PFD and averages the data.

### **A/T LIMITING**

The A/T system provides speed and thrust envelope limiting. Thrust envelope limiting is based on the active EPR rating, while speed envelope limiting is based on minimum speed limits as well as placard and structural speed limits.

## A/T MONITORING

Monitoring is incorporated in the A/T system to ensure control integrity. The monitoring consists of validity, servo response and pilot override monitoring. Validity monitoring ensures that all parameters required for A/T control, during a specific phase of flight, are present and valid and detects engine out, engine reversion, thrust reverser deployment and internal faults. The servo response monitor compares the servo response with the commanded response to ensure the integrity of the servo control system. The pilot override monitor detects pilot movement of the thrust levers while the A/T system is engaged, to provide automatic disconnect of the A/T system.

## ELECTRONIC THRUST TRIM SYSTEM (ETTS)

The electronic engine trim system will command limited authority thrust. The trim system will perform trimming to assist the A/T as well as the crew at setting trimmed thrust. In addition, the system will perform N1/N2 synchronization when selected by the crew. The engine trim operating mode (N1 SYNC, N2 SYNC, EPR CMD SYNC and NO SYNC) are selectable via the FMS CDU. Only one operating mode can be active at a time. Selection of an operating mode arms the Sync system for engagement, when the conditions and flight phase are appropriate.

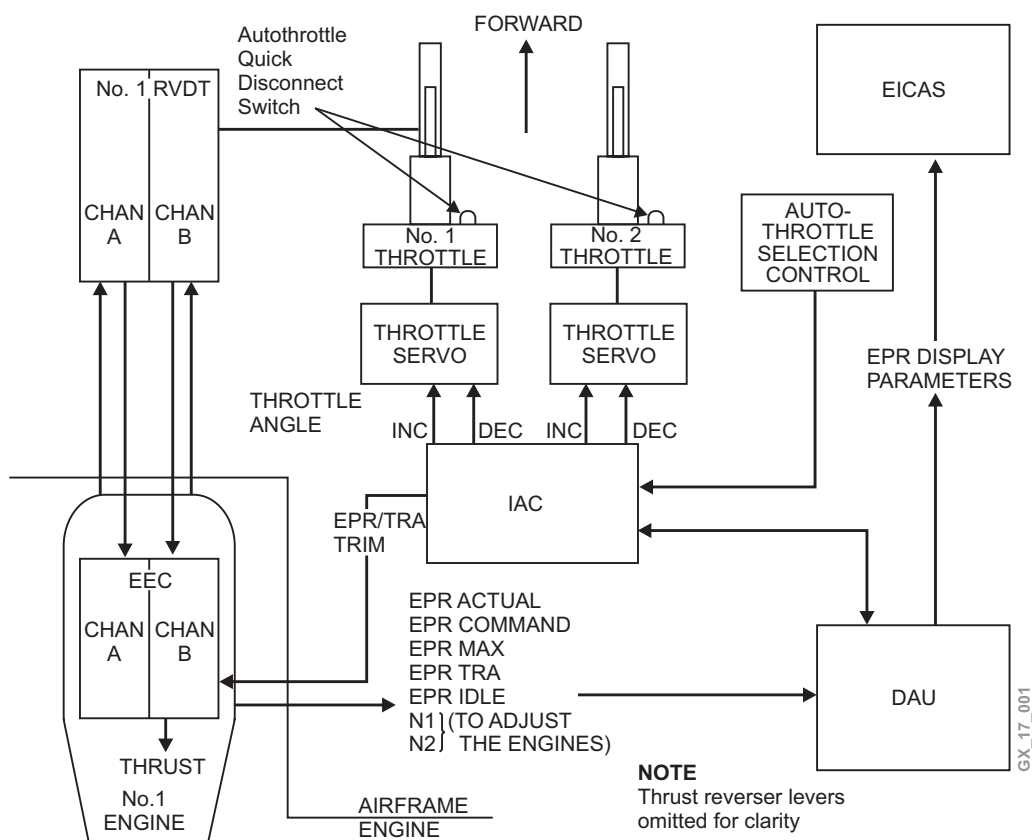

## SYNC MODE SELECTION

The engine synchronization (SYNC) function is selected automatically by the autothrottle system (if engaged), or manually via the FMS. SYNC system will compare engine speeds and compute a trim value in order to match the two engine speeds. SYNC mode may be selected by the crew for takeoff below 400 feet, but it is inhibited in the automatic mode below 400 feet. N1 shaft speed, N2 shaft speed or EPR mode can be synchronized.

The ETTS provides EPR trim, N1 synchronization, N2 synchronization, engage status as well as fault annunciation on EICAS.

N1 SYNC will be selected by default on FMS power-up.

In the following tables:

- Cruise phase refers to all in-flight phases except takeoff, approach and go around
- The approach mode is based on flaps  $\geq 16^\circ$  and landing gear down or the active AP/FD mode being glideslope or glide path capture
- EPR sync is active throughout all phases of flight except for the landing
- N1 and N2 are inhibited during the approach phase to prevent unwanted thrust reductions, in the event of an engine out

## N1 SYNC ON

A/T ON	A/T OFF
<b>T/O Phase</b> Trim activates when both thrust levers are set to a position corresponding to a thrust setting greater than 60% maximum thrust. Trims to higher of two EPR CMDs from FADEC's. Trims to T/O EPR setting when within trim authority range.	<b>T/O Phase</b> No active trim command. Trim commands are zeroed.
<b>Cruise Phase</b> N1 Sync performed as thrust levers are moved between the active cruise rating and flight idle rate settings. Trimming to the computed A/T EPR.	<b>Cruise Phase</b> N1 Sync performed as thrust levers are moved between the active cruise rating and flight idle rate settings.
<b>Approach Phase</b> Trimming to the computed A/T EPR.	<b>Approach Phase</b> No active trim commands. Trim commands are zeroed.
<b>GA Phase</b> Trims to higher of two EPR CMDs. Trims to GA EPR setting when within range of GA EPR rating.	<b>GA Phase</b> No active trim commands. Trim commands are zeroed.

**N2 SYNC ON**

A/T ON	A/T OFF
<p>T/O Phase Trim activates when both thrust levers are set to a position corresponding to a thrust setting greater than 60% maximum thrust. Trims to higher of two EPR CMDs from FADEC's. Trims to T/O EPR setting when within trim authority range.</p>	<p>T/O Phase No active trim command. Trim commands are zeroed.</p>
<p>Cruise Phase N2 Sync performed as thrust levers are moved between the active cruise rating and flight idle rate settings. Trimming to the computed A/T EPR.</p>	<p>Cruise Phase N2 Sync performed as thrust levers are moved between the active cruise rating and flight idle rate settings.</p>
<p>Approach Phase Trimming to the computed A/T EPR.</p>	<p>Approach Phase No active trim commands. Trim commands are zeroed.</p>
<p>GA Phase Trims to higher of two EPR CMDs. Trims to GA EPR setting when within range of GA EPR rating.</p>	<p>GA Phase No active trim commands. Trim commands are zeroed.</p>

**EPR CMD SYNC ON**

A/T ON	A/T OFF
<p>T/O Phase Trim activates when both thrust levers are set to a position corresponding to a thrust setting greater than 60% maximum thrust. Trims to higher of two EPR CMDs from FADEC's. Trims to T/O EPR setting when within trim authority range.</p>	<p>T/O Phase Trim activates when both thrust levers are set to a position corresponding to a thrust setting greater than 60% maximum thrust. Trims to higher of two EPR CMDs from FADEC's. Trims to T/O EPR setting when within trim authority range.</p>
<p>Cruise Phase Trimming to the computed A/T EPR.</p>	<p>Cruise Phase Trimming to the average of the two EPR CMDs.</p>
<p>Approach Phase Trimming to the computed A/T EPR.</p>	<p>Approach Phase Trimming to the average of the two EPR CMDs.</p>
<p>GA Phase Trims to higher of two EPR CMDs. Trims to GA EPR setting when within trim authority range.</p>	<p>GA Phase Trims to higher of two EPR CMDs. Trims to GA EPR setting when within trim authority range.</p>



## N1, N2, EPR CMD SYNC OFF

A/T ON	A/T OFF
T/O Phase Trim activates when both thrust levers are set to a position corresponding to a thrust setting greater than 60% maximum thrust. Trims to higher of two EPR CMDs from FADECs. Trims to T/O EPR setting when within trim authority range.	T/O Phase No active trim command. Trim commands are zeroed.
Cruise Phase Trimming to the computed A/T EPR.	Cruise Phase No active trim command. Trim commands are zeroed.
Approach Phase Trimming to the computed A/T EPR.	Approach Phase No active trim command. Trim commands are zeroed.
GA Phase Trims to higher of two EPR CMDs. Trims to GA EPR setting when within range of GA EPR rating.	GA Phase No active trim command. Trim commands are zeroed.

The phase of flight is determined by the electronic trim system and is based on the A/T mode, as well as the active autopilot/flight director pitch mode.

The electronic trim system will hold trim commands at 60 knots during T/O roll in order to prevent undesirable thrust changes during T/O phase between 60 knots and 400 feet. The trim commands cannot be changed, including deselection, until the airplane transitions 400 feet above ground level.

### SYNC ANNUNCIATION

A SYNC annunciation will be displayed on N1 or N2 or EPR, when the sync system is engaged and is issuing electronic trim commands.



There will be no SYNC annunciation while:

- A/T is engaged with EPR CMD sync selected
- A/T is not engaged during T/O or approach phase with EPR CMD sync selected

The engine trim control is not available for the following conditions:

- Engine out condition
- While an engine is in reversionary control (N1 control)
- While data, required for control, is invalid

### A/T 1 OR 2 SELECT

AUTOTHROTTLE channel is automatically selected. To manually change the selection, select MENU twice on the MFD control panel, then select AUTOTHROTTLE 1 or 2 and select ENT.

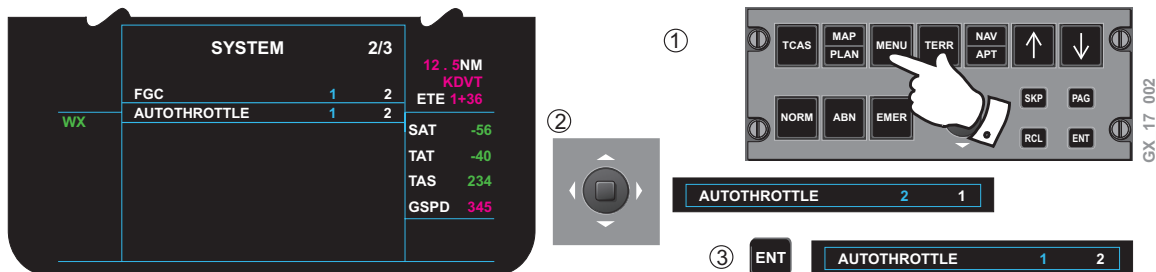

### NOTE

Unlike the autopilot computers, there is no automatic transfer between Autothrottle Computer 1 and Autothrottle Computer 2. A manual reversion must be done via the MFD control panel.

### A/T ENGAGEMENT/DISENGAGEMENT

A/T Engagement - The A/T system is engaged or armed to engage by toggling the A/T engage/disengage switch(es), located on either thrust lever.

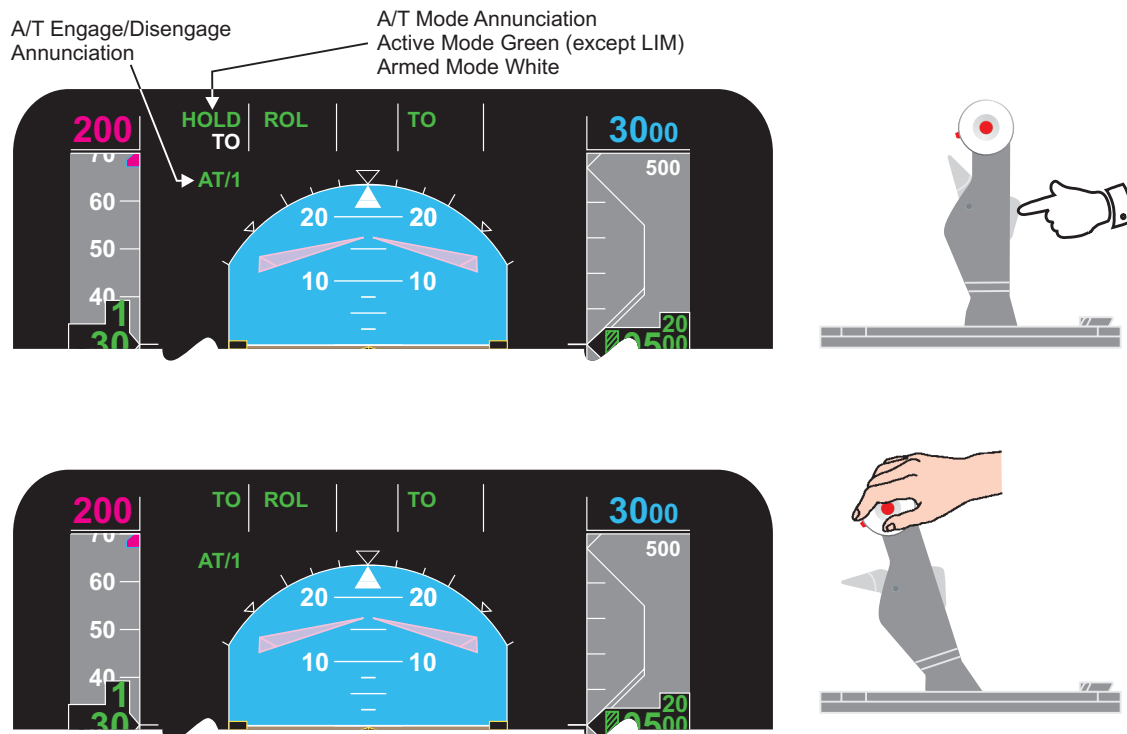

Toggling the switches, while on the ground, during T/O phase, with the thrust levers less than 60% of max. thrust (23° TRA), will engage the A/T in an armed state. Subsequent advancement of both thrust levers above 60% maximum thrust, while airspeed is less than 60 knots, will result in automatic engagement of the system into takeoff thrust control, moving the thrust levers to the appropriate thrust settings.

Toggling the switches, while on the ground, with the thrust levers greater than 60% maximum thrust, while airspeed is less than 60 knots, will engage the system directly into takeoff thrust control.

Toggling the switches, while in flight, above 400 feet, will engage the system into a control mode which is compatible to the active AP/FD mode. In the event that no AP/FD mode has been selected, the A/T will engage into basic speed control mode.

Engagement is inhibited during a detected fault condition or during an invalid flight condition. The A/T system can be disengaged both manually and/or automatically.

### A/T DISENGAGEMENT

Automatic disengagement will occur when the A/T system, for any engaged or on-ground armed state, in the event of a detected system failure (abnormal disconnect) or when A/T control is inappropriate for the current phase of flight (normal disconnect) such as on the ground, following touchdown. The A/T annunciation will turn red and flash, and an aural AUTOTHROTTLE is generated when the A/T is disengaged automatically or manually. The aural AUTOTHROTTLE is not generated when the A/T disconnects due to aircraft weight on wheels on touchdown.

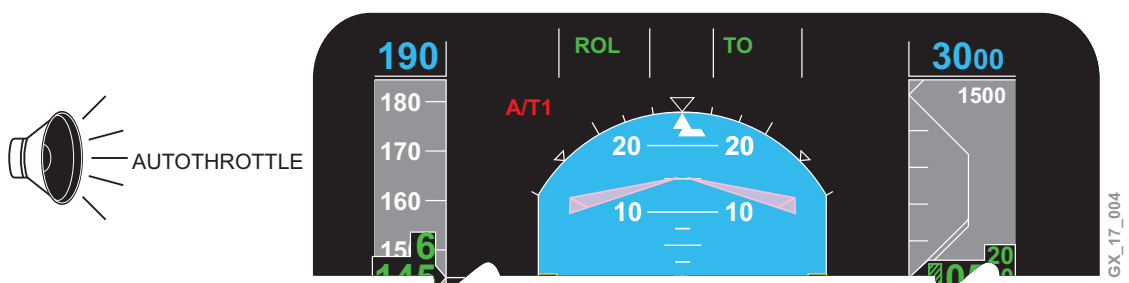

A normal disconnect results in a one-second aural warning as A/T 1 or A/T 2 is removed from the PFD. An abnormal disconnect results in flashing A/T 1 or A/T 2 annunciation continuously, along with a continuous aural warning, until the crew confirms the disengagement by pressing the quick disconnect button(s).

## A/T DISENGAGEMENT AND MANUAL OVERRIDE

Manual disengagement of the system, for both inflight and on-ground operation, is accomplished by the crew in the following manner:

- Pressing the quick disconnect button(s), located on either thrust lever, while the system is engaged or in an on-ground armed state (normal disconnect)
- Toggling the engage/disengage switch(es), located on either thrust lever, while the system is engaged or in an on-ground armed state (normal disconnect)
- Overriding the system by manually positioning the thrust levers, while A/T is engaged. Movement of the thrust levers while on-ground T/O armed state will not disconnect the system (abnormal disconnect)

① Pressing quick disconnect button(s)

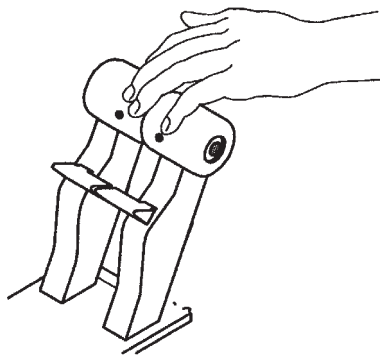

② Toggling the engage/disengage switch(es)

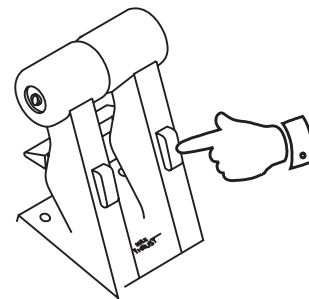

AUTOTHROTTLE

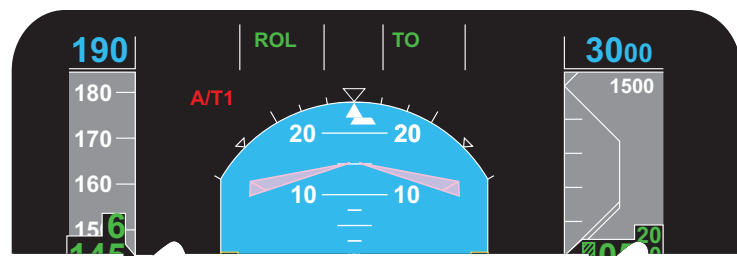

GX\_17\_005

③ Overriding by manually advancing or retarding the thrust levers.

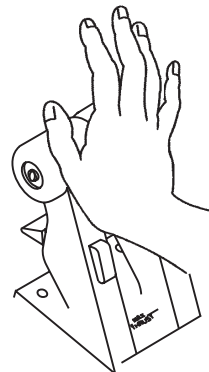

### A/T MODE OPERATION

The A/T system is integrated with the flight control systems of the airplane to provide compatibility with the active vertical mode of the Flight Guidance System (FGS). The flight guidance vertical mode is normally determined by the flight director or autopilot and is influenced by the FMS during vertical navigation control. The A/T mode operation results in A/T thrust control which compliments the pitch control being performed by the FGS. In the event that no FGS vertical mode is active, the A/T will provide independent thrust control based on internally computed mode.

The following table outlines the integrated functional control provided by the A/T and FGS for the various control modes of the AP/FD and FMS for specified phases of a typical flight.

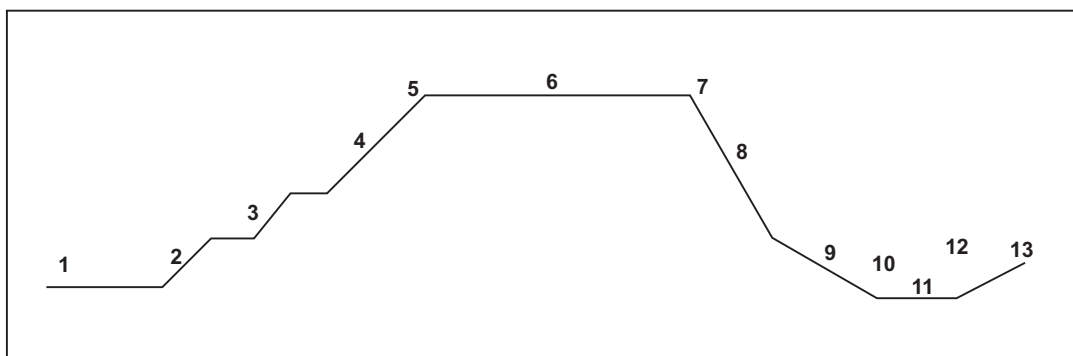

GX\_17\_006

	FLIGHT PHASE	AP/FD VERTICAL MODE	FMS VERTICAL MODE (VNAV)	AUTOTHROTTLE FUNCTION	AP/FD/FMS FUNCTION
1	Takeoff Roll	Takeoff (TO)	N/A	Sets TO rated thrust or FLEX reduced thrust by controlling to the MAX or FLEX EPR rating. Throttle servos depower when airspeed reaches 60 knots	Pitch Control
2	Takeoff Climb Out	Takeoff (TO)	N/A	Throttle servos remain depowered until 400 ft. Above 400 ft AGL A/T controls to active MAX or FLEX T/O EPR rating	Airspeed control during FLC and VFCL. Pitch Control during PIT. Vertical speed control during VS
3	Small Flight Level Changes (Climb)	Flight Level Change (FLC), Pitch Hold (PIT) Vertical Speed (VS)	VNAV Flight Level Change (VFCL)	Reduced climb thrust during FLC and VFCL. Airspeed control during PIT and VS	Airspeed control during FLC and VFCL. Pitch Control during PIT. Vertical speed control during VS
4	Large Flight Level Changes (Climb)	Flight Level Change (FLC), Pitch Hold (PIT) Vertical Speed (VS)	VFLC	Reduced climb thrust during FLC and VFCL. Airspeed control during PIT and VS	Airspeed control during FLC and VFCL. Pitch Control during PIT. Vertical speed control during VS
5	Top of Climb (TOC)	Altitude Capture (ASEL)	VNAV Altitude Capture (VASEL)	Airspeed Control	Altitude Capture Control
6	Cruise	Altitude Hold (ALT)	VNAV Altitude Hold (VALT)	Airspeed Control	Altitude Control
7	Top of Descent (TOD)	FLC or VS	VFLC	Transition to idle thrust during FLC and VFCL. Airspeed control for VS	Airspeed control during FLC and VFCL. Vertical speed control during VS
8	FLC (Descent)	FLC, PIT or VS	VFLC or VNAV Path Descent (VPATH)	Full idle thrust during FLC and VFCL. Airspeed control during PIT, VS and VPATH	Airspeed control during FLC and VFCL. Pitch Control during PIT. Vertical speed control during VS and VPATH
9	Approach	Glideslope Track	N/A	Airspeed Control	Glideslope Control
10	Flare	Glideslope Track	N/A	Thrust retard to idle stop	Disengaged
11	Landing/Roll	N/A	N/A	Disengaged	Disengaged
12	Go Around	Go Around	N/A	Sets TO	Pitch Control
13	Windshear	Windshear	N/A	Sets TO	Pitch Control

### TAKEOFF THRUST CONTROL MODE

The takeoff thrust control mode is activated when the A/T is armed for engagement for takeoff, airspeed less than 60 knots and both thrust levers are set above 23°, corresponding to 60% of maximum thrust. Once activated, the A/T will advance the thrust to the TO EPR rating. The A/T will control the thrust lever to the active EPR rating during takeoff roll until the airspeed increases above 60 knots, at which time the takeoff thrust hold control mode activates.

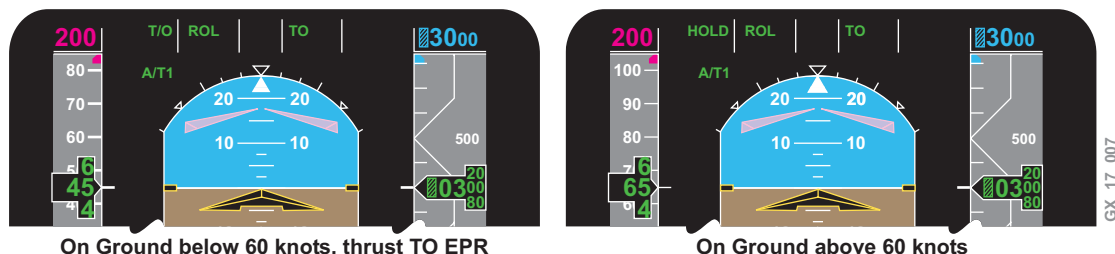

The takeoff thrust control mode reactivates at an altitude transition of 400 feet during the takeoff climb-out. If a change to the active EPR rating, either by the crew or by automatic means, has occurred, then the A/T will control the engine power setting to the new active rating.

### TAKEOFF THRUST HOLD CONTROL MODE

The takeoff thrust hold control mode is activated to ensure that no thrust reductions occur during takeoff between the time the airplane transitions above 60 knots to 400 feet AGL.

The takeoff thrust hold control mode deactivates as the airplane transitions through 400 feet AGL during takeoff climb out.

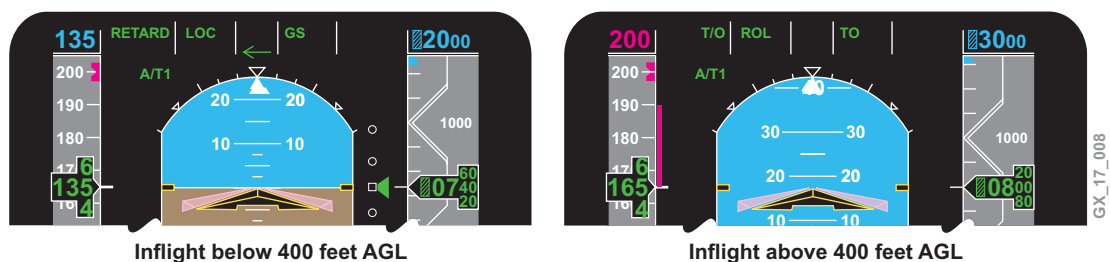

A/T T/O mode will remain enabled until 400 feet AGL. Following the 400 feet AGL transition, with A/T engaged, T/O mode remains active until a non T/O AP/FD mode activates.

### NOTE

Anytime an A/T mode changes, it will flash for 5 seconds.

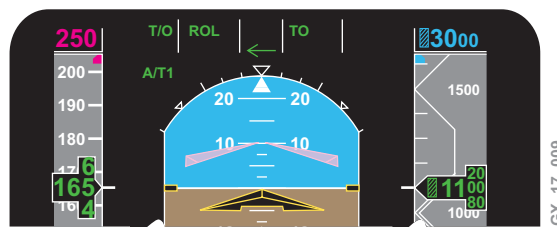

Inflight TO mode selected on AP/FD

### FLIGHT LEVEL CHANGE THRUST CONTROL MODE

The flight level change thrust control mode activates when crew selects the FLC mode or when FMS engages the VFLC mode. The A/T selects the active upper/lower EPR rating for climb/descent.

The active upper and lower EPR ratings are either computed from the phase of flight or are pilot selected via an EPR rating menu.

For small flight level change climbs and descents, the A/T will provide thrust as required to attain a programmed rate of climb/descent. The programmed rate of climb/descent is proportional to the magnitude of the selected altitude change. Full power climbs and full idle descents are achieved when the target climb/descent rate increases beyond the capability of the airplane for the active upper and lower EPR rating.

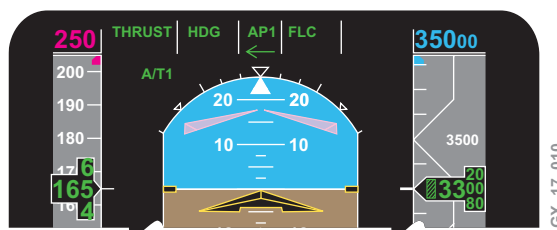

Inflight HDG and FLC selected on AP/FD

When the selected altitude is captured, the thrust mode will automatically change to SPD mode.

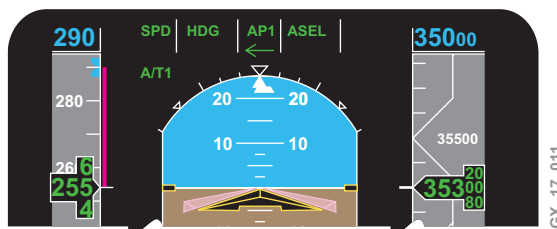

Flight Level Change mode transition to SPD Mode

## AIRSPEED CONTROL MODE

The airspeed control mode is the basic control mode of the A/T. Engagement of the A/T system in-flight, with no AP/FD mode engaged, will result in the A/T engaging in airspeed control mode. Airspeed control mode is also active if the A/T is engaged in-flight with the AP/FD engaged in:

- Altitude capture (ASEL)
- Altitude hold (ALT)
- Vertical speed (VS), pitch hold (PIT), or
- Glideslope track (GS) modes

The airspeed control mode tracks the active airspeed (IAS) or Mach target. The airspeed target is selected on the flight guidance panel and is modified by the FMS or manually. LIM is annunciated when the A/T cannot reach the speed target due to either not enough thrust available to climb or thrust at IDLE and configuration will not allow a deceleration.

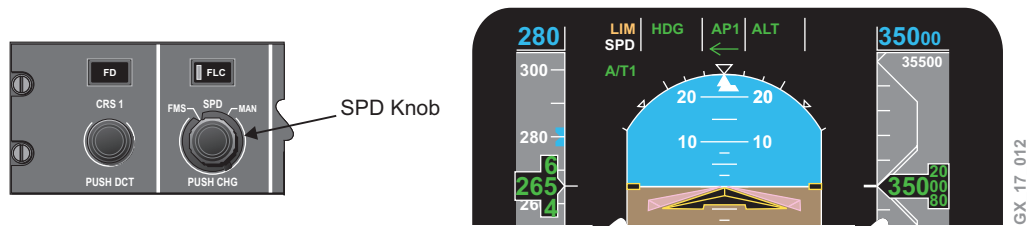

The airspeed control mode provides high and low speed protection. In the event that the active speed target is above the structural limits ( $V_{mo}$ ,  $M_{mo}$ , Gear and Flaps placards) minus 3 knots, the A/T will limit the speed to the lower of the appropriate limits, as a function of airplane configuration, minus 3 knots.

In the event that the active speed target is below the lower speed limit, the A/T will limit the speed to one of the following:

1. If the A/T is in approach mode (flaps 16 or greater and gear down, or GS mode active) the minimum speed is limited to 1.3  $V_s$ .
2. If the A/T is not in approach mode, the speed is limited to 1.2  $V_s$  + 3 kts.

The SPD active mode will go to armed and LIM will be active.

In the event that a speed target is selected that requires an engine EPR higher than the upper active EPR rating or lower than the active lower EPR rating, the A/T will limit the commanded thrust to the appropriate EPR rating.



## RETARD MODE

The retard mode control provides a fixed-rate thrust lever retard of both thrust levers to the idle position during airplane flare or landing. The A/T remain engaged until touchdown to provide go around thrust if go around mode is selected.

The retard mode activates based on the radio altitude of less than 50 feet AGL, if the airplane is in landing configuration (gear down and flaps  $\geq 16^\circ$ ).

In the event that the airplane touches down without the A/T retarding the thrust levers, due to failing to detect a landing configuration or lack of valid radio altitude. Upon touchdown detection, the A/T will disconnect and throttle levers position and engine rpm remain the same.

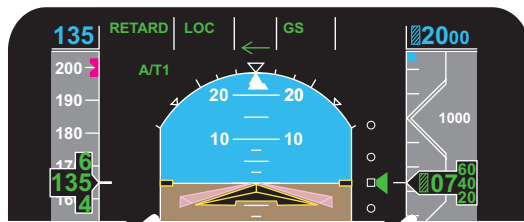

Example: Flare and less than 50 feet Rad Alt.

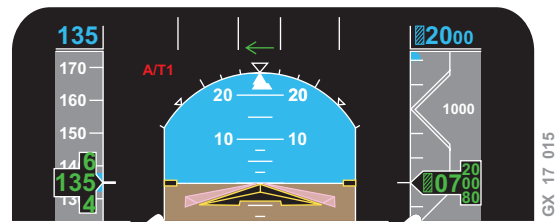

Example: Touchdown

GX\_17\_015

## GO AROUND THRUST CONTROL MODE

The A/T go around mode provides a fixed rate thrust lever advance to the active upper EPR rating in response to the activation of the AP/FD go around mode.

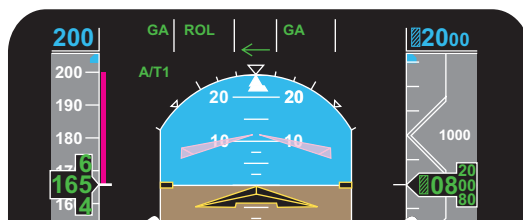

Go Around Mode Activated

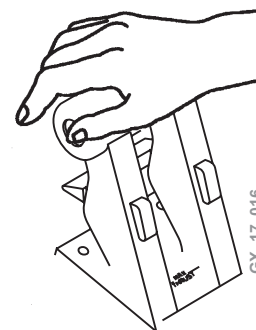

TOGA Switch Activated

GX\_17\_016

## **THRUST REVERSER SYSTEM**

The thrust reversers provide additional deceleration to assist during landing and rejected takeoff.

The thrust reverser is a pivoting door type. When deployed, the upper and lower doors pivot to redirect exhaust gases through the top and bottom of the nacelle, eliminating forward thrust and providing a braking effect. Each door has a kicker plate, attached to its front edge, designed to ensure that the exhaust gases are ejected in the proper direction.

In-flight the pivot doors are locked closed.

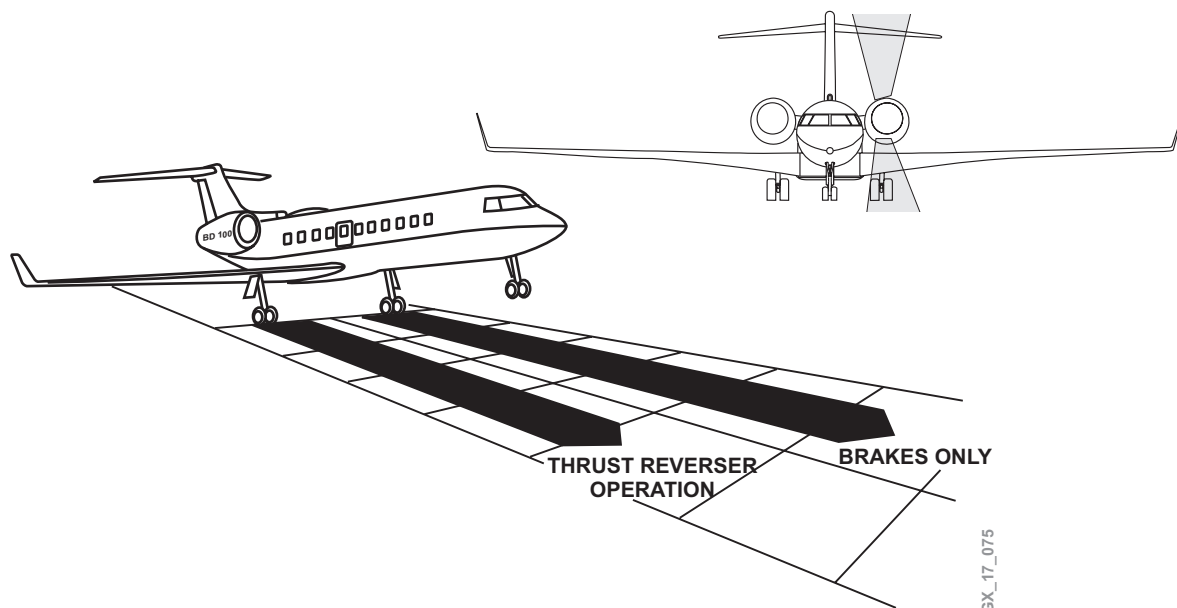

## **THRUST REVERSER**

The thrust reverser is powered by hydraulic system No. 1 for the left reverser and hydraulic system No. 2 for the right reverser, and is controlled by the EEC and electrical signals from the airplane.

The hydraulic system comprises:

- Isolation Control Unit - controlled by the EEC
- Directional Control Unit - controlled by electrical signals
- Primary Lock Actuators - lock both upper and lower doors
- Door Actuators - one for each door

The electrical system comprises:

- Tertiary Locks - one for each door, feedback signal to cockpit
- Stow Switches - two per door, stow signal feedback to EEC
- Linear Variable Transformer (LVT) - one per door, LVT signals door position to EEC
- Maintenance Test Switch - allows thrust reverser deployment without engine operating

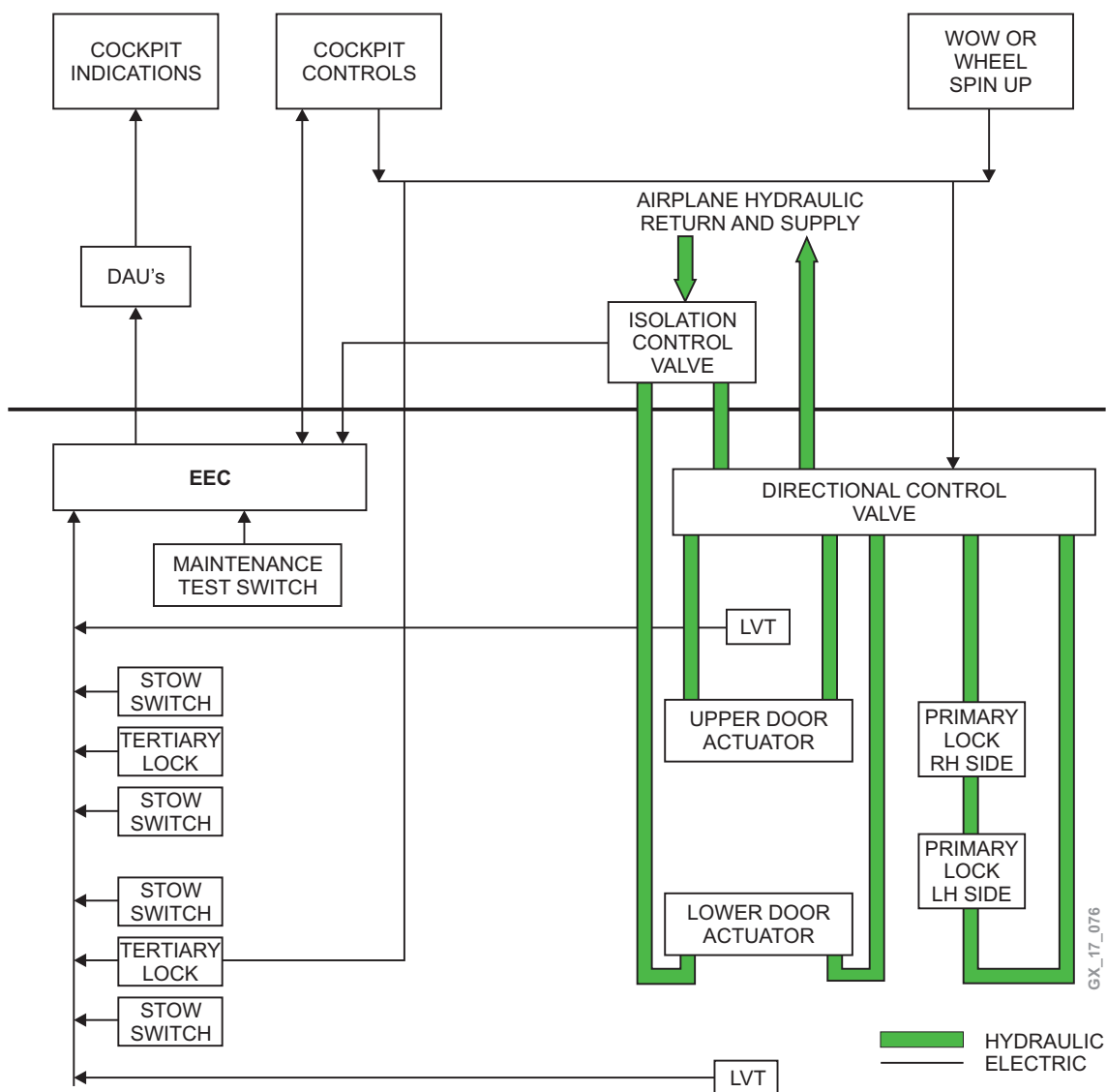

## REVERSE THRUST OPERATION

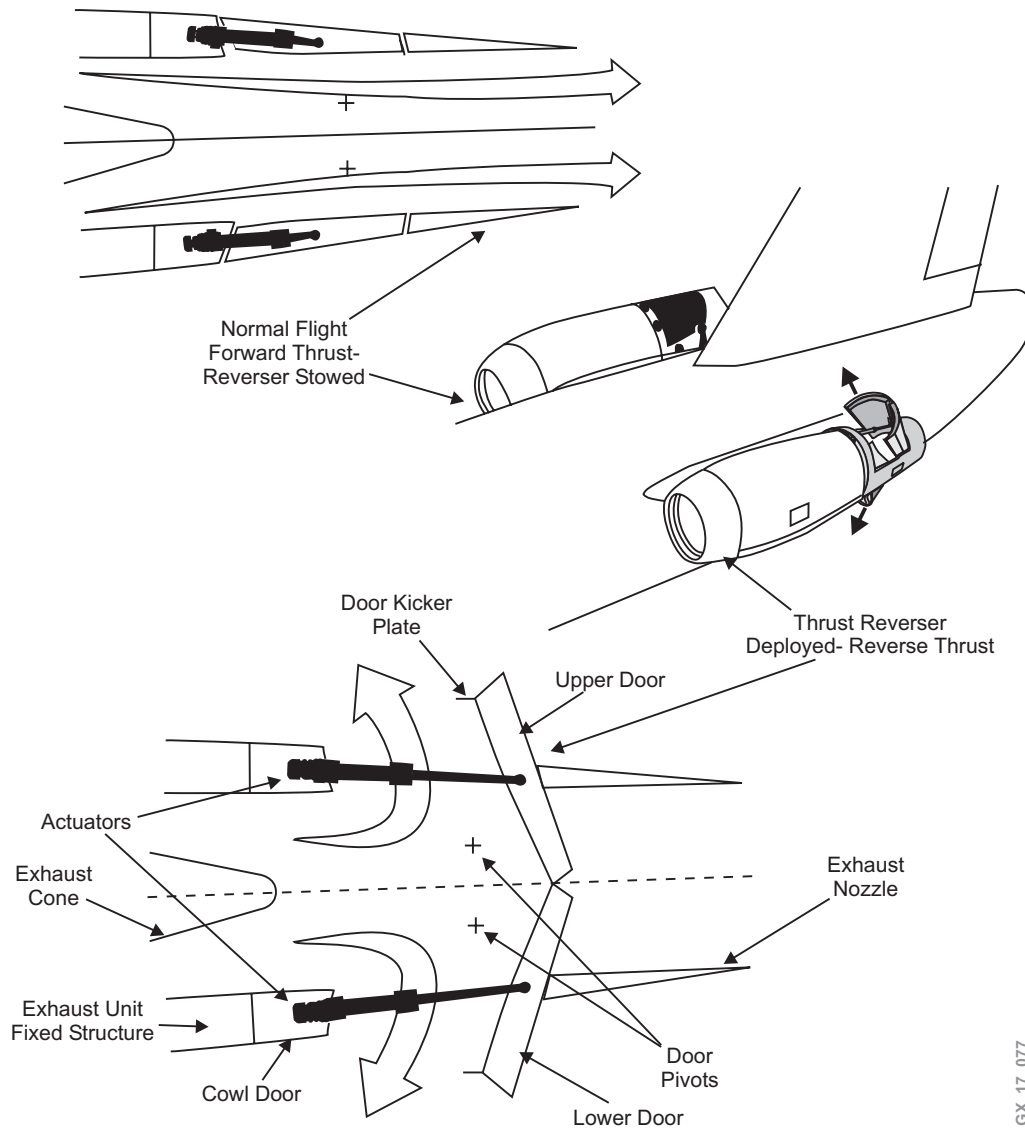

GX\_17\_077

**REVERSER COMPONENTS**

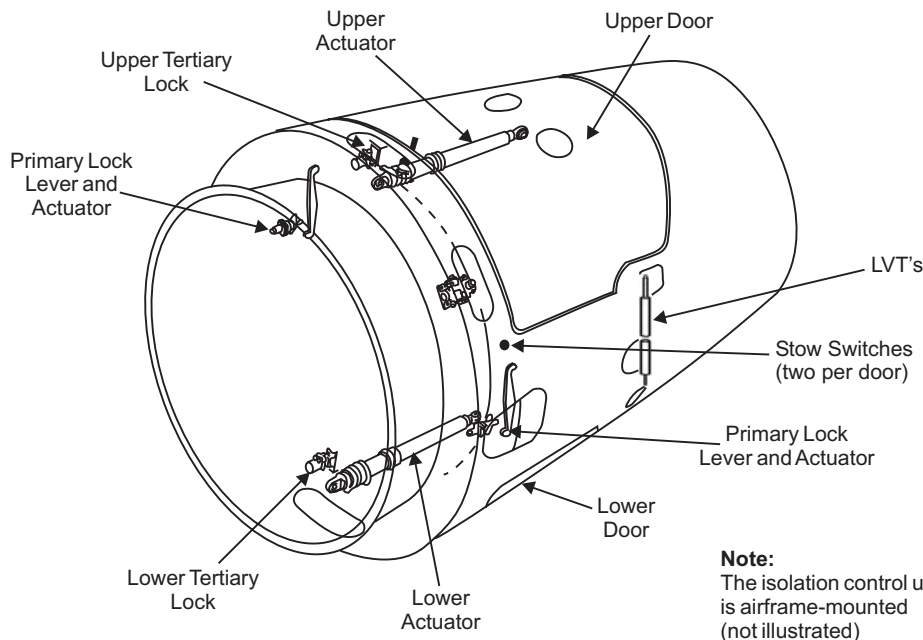

**Isolation Control Unit**

The isolation control unit controls the hydraulic system pressure to the thrust reverser system.

**DIRECTIONAL CONTROL UNIT**

The directional control unit controls hydraulic pressure to the upper and lower door actuators to provide the deploy force.

A pressure switch sends a signal to the directional control unit and through the directional control unit to the upper and lower door actuators. This causes an overstow of the doors to enable unlatching of the primary locks.

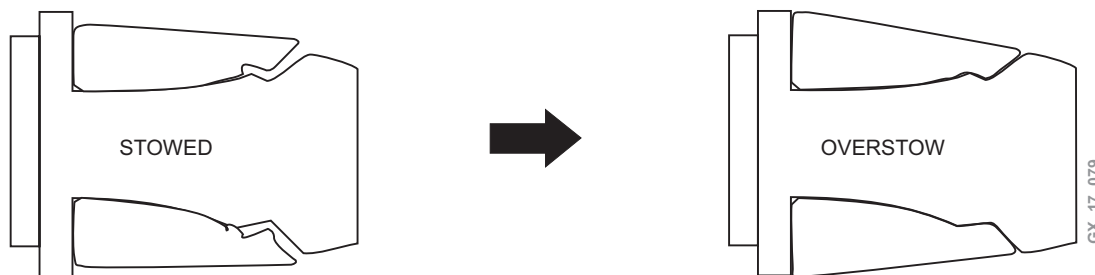

The unit contains the directional control valve which is controlled by a solenoid valve. The solenoid valve is controlled from thrust lever microswitches and WOW and wheel spin up signals. When the solenoid is energized, a deploy valve opens allowing hydraulic pressure to sequentially release the two primary locks (hold doors closed during flight).

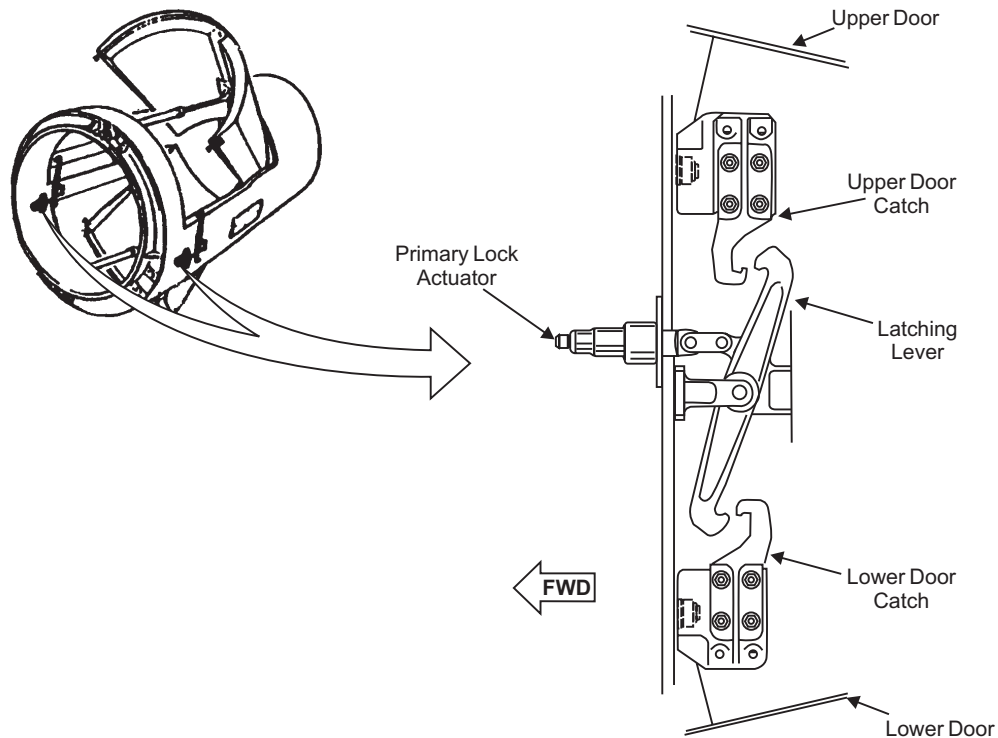

Through the WOW or wheel spin up signal two tertiary locks (prevent uncommanded thrust reverser deployment) will retract and move the directional control valve to the deploy position.

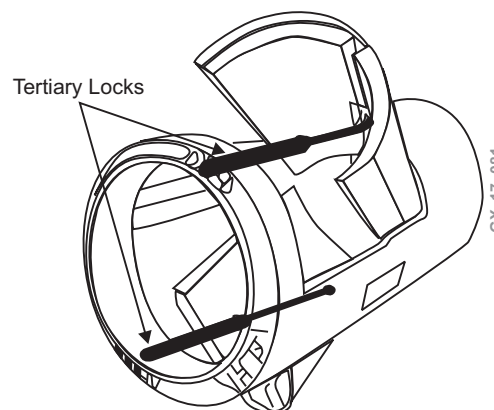

## REVERSE THRUST LEVERS

The reverse thrust lever microswitches and interlock baulk switches will not allow the engine to increase reverse thrust until the upper and lower doors are deployed. REV icons are displayed on N1 display, to indicate position of doors and reverser status.

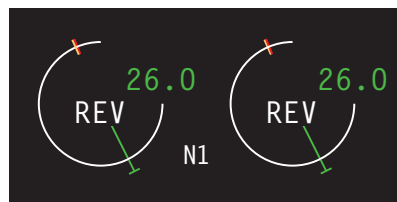
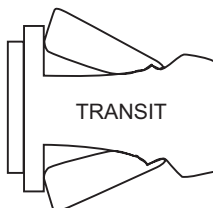
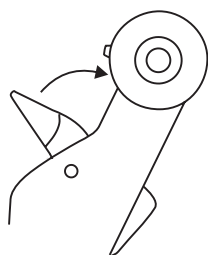

REVERSE THROTTLE LEVER INTERLOCK BAULK POSITION

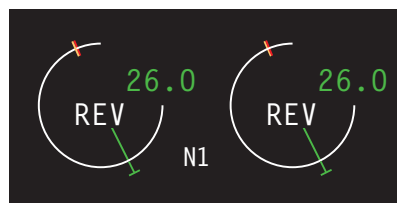
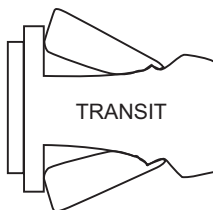
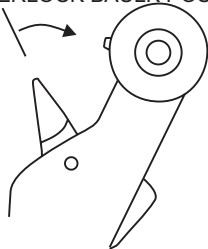

REVERSE THRUST INCREASE

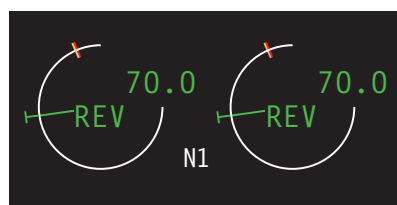
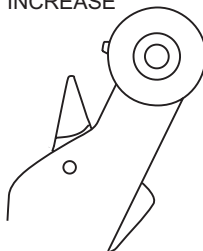
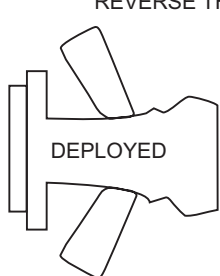

GX\_17\_082

In the event that a thrust reverser should become unlocked, an EICAS message will be displayed, an aural warning is generated and the thrust is retarded to idle regardless of thrust lever position. Should the door open, a red REV icon will be shown in the N1 gauge.



LEFT REVERSER UNLOCKED

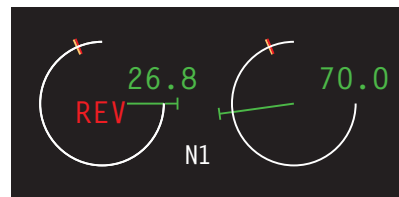

GX\_17\_083

## REVERSER SYSTEM LOCKOUT

In the event that a reverser fails (inoperative), the affected reverser can be locked out.



Each door can be fixed in the closed position by an inhibition bolt and by use of a manual inhibit lever on the isolation control unit.

When fitted, the red bolts will protrude above the cowl surface and can be seen by the crew on walkaround. The bottom bolt is located at approximately the six o'clock position and the top bolt at the 12 o'clock position. The EICAS message will remain posted, but can be scrolled out of view.

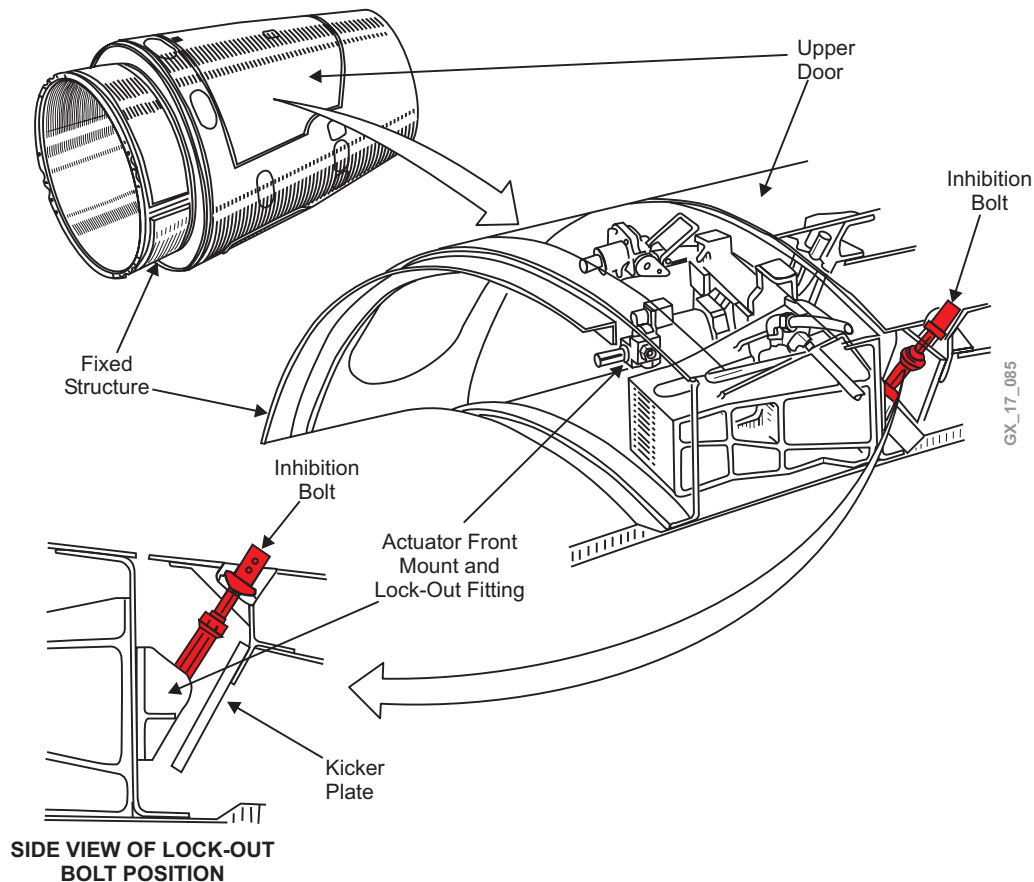



POWER PLANT EICAS MESSAGES

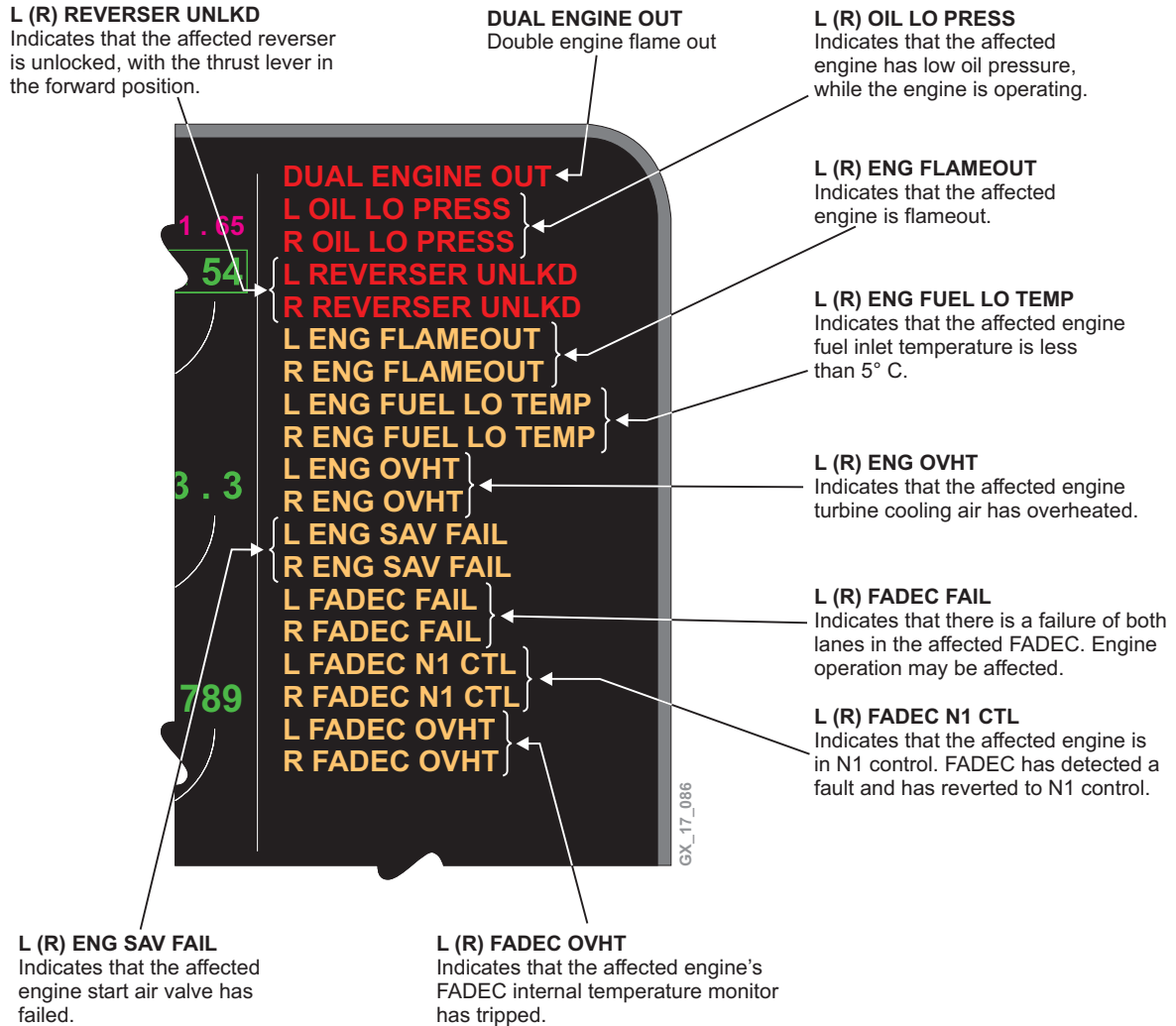

**POWER PLANT EICAS MESSAGES (CONT)**

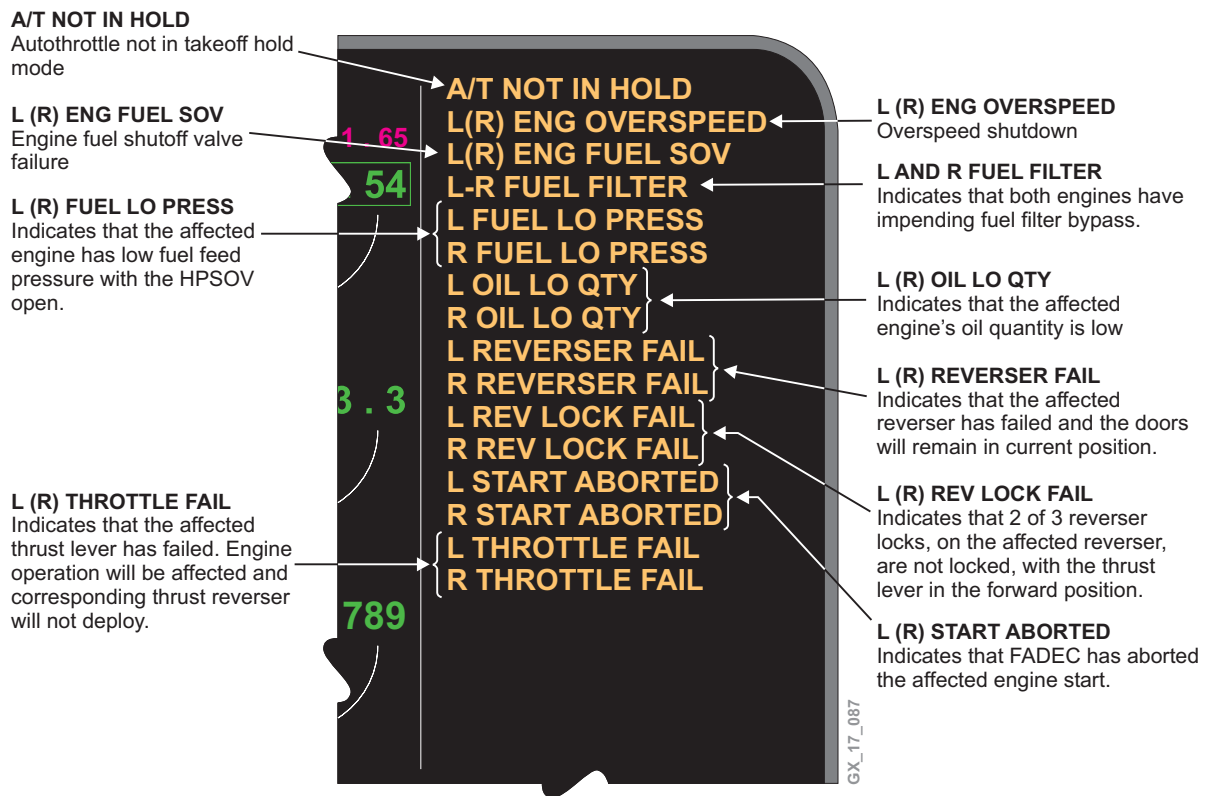

POWER PLANT EICAS MESSAGES (CONT)

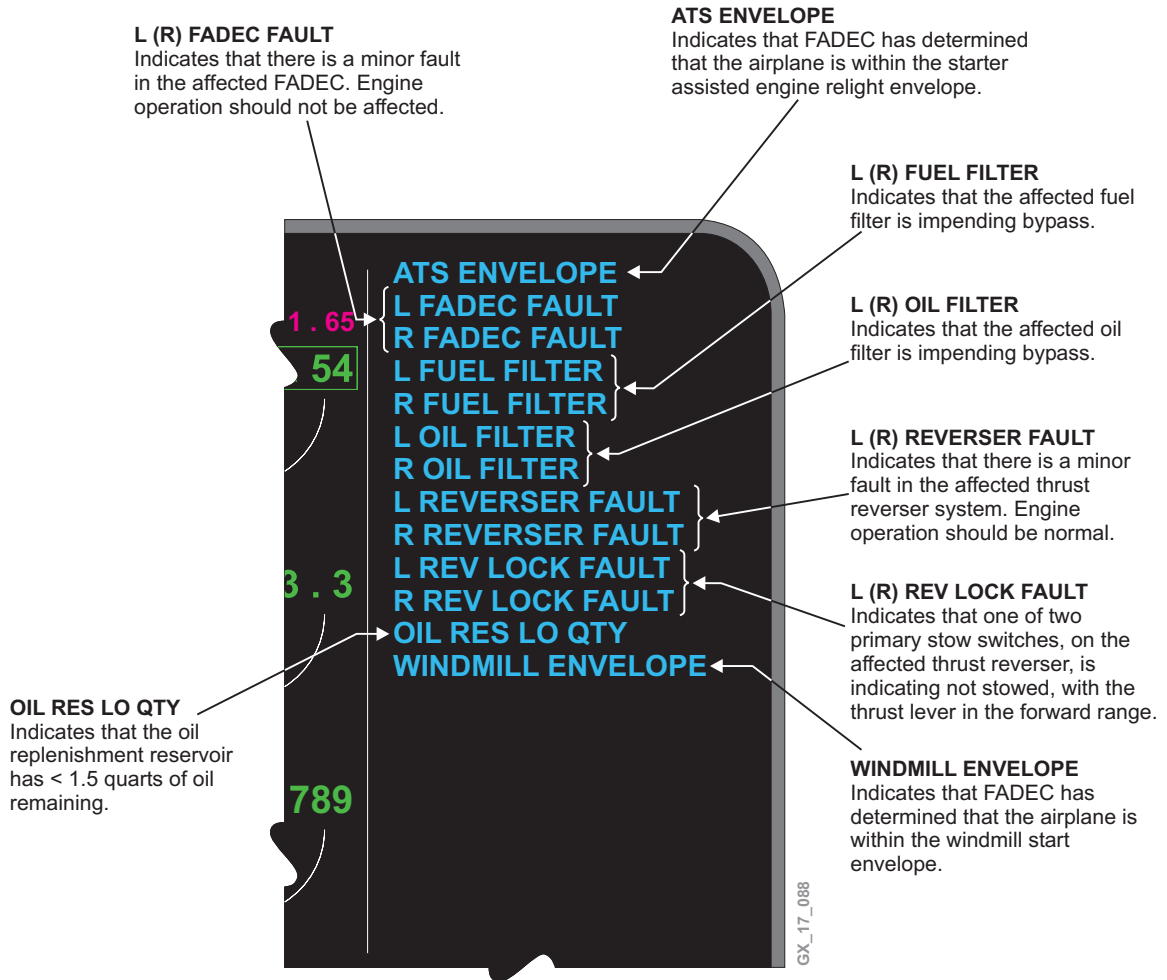

POWER PLANT EICAS MESSAGES (CONT)

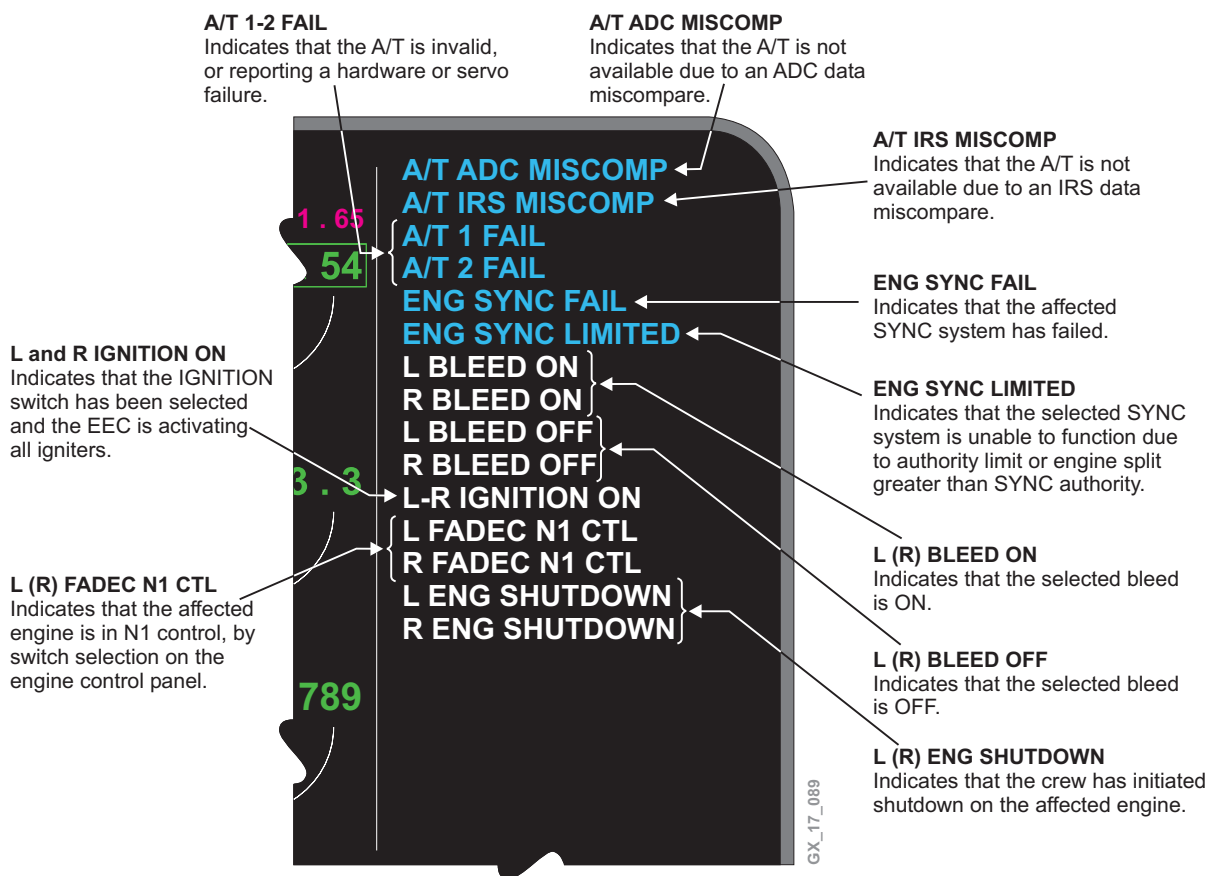

**EMS CIRCUIT PROTECTION**

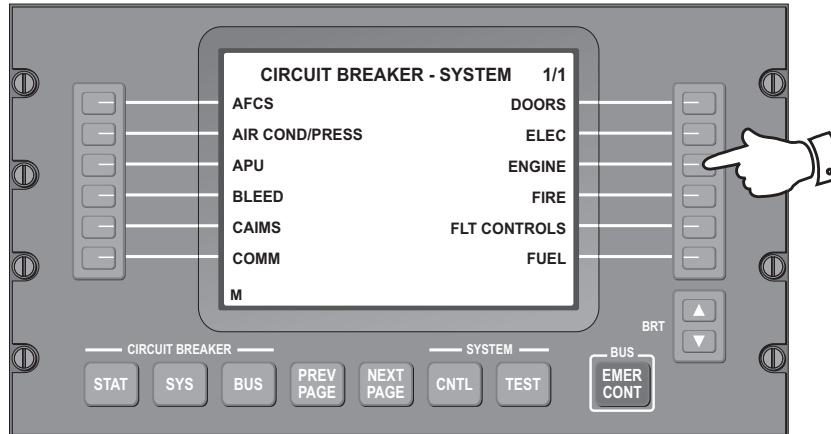

<b>CB - ENGINE SYSTEM</b>			<b>1/3</b>
L ENG FUEL HPSOV	BATT		IN
L ENG IGN 1	BATT		IN
L ENG IGN 2	BATT		IN
L ENG START A	BATT		IN
L ENG START B	BATT		IN
L FADEC CH A	BATT		IN
<b>CB - ENGINE SYSTEM</b>			<b>2/3</b>
L FADEC CH B	BATT		IN
R ENG FUEL HPSOV	BATT		IN
R ENG IGN 1	BATT		IN
R ENG IGN 2	BATT		IN
R ENG START A	BATT		IN
R ENG START B	BATT		IN
<b>CB - ENGINE SYSTEM</b>			<b>3/3</b>
R FADEC CH A	BATT		IN
R FADEC CH B	BATT		IN
VIBE MONITOR	DC 1		IN
<b>M</b>			

GX\_17\_090

**EMS CIRCUIT PROTECTION (CONT)**

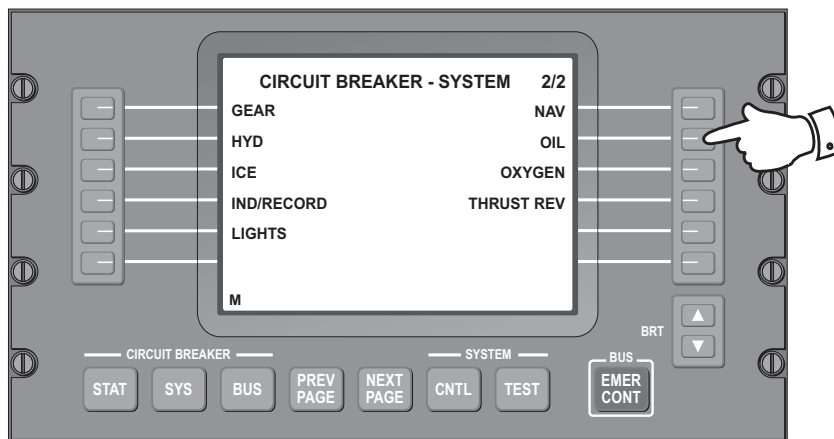

CB - OIL SYSTEM 1/1		
APU LUBE	BATT	IN
L ENG LUBE	BATT	IN
LUBE PUMP	BATT	IN
R ENG LUBE	BATT	IN
M		

GX\_17\_091

**EMS CIRCUIT PROTECTION (CONT)**

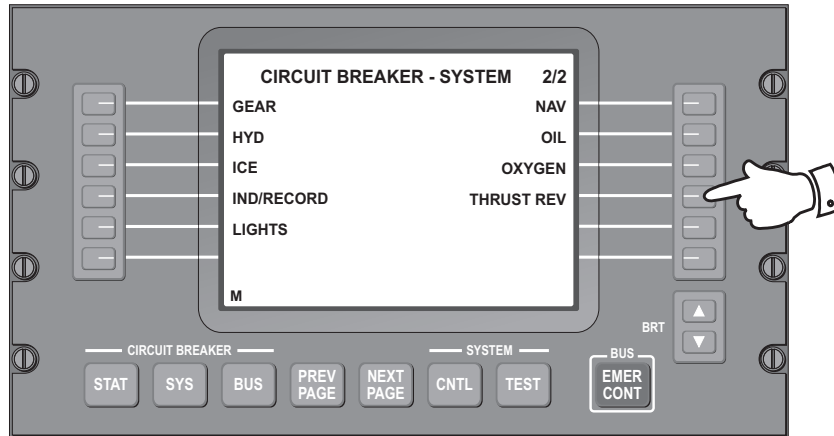

CB - THRUST REV SYSTEM 1/2		
L T/R CTL VALVE	BATT	IN
L T/R LOWER LOCK	BATT	IN
L T/R TQA LOCK	BATT	IN
L T/R UPPER LOCK	BATT	IN
R T/R CTL VALVE	BATT	IN
R T/R LOWER LOCK	BATT	IN
CB - THRUST REV SYSTEM 1/2		
R T/R TQA LOCK	BATT	IN
R T/R UPPER LOCK	BATT	IN
M		

GX\_17\_092

PAGE INTENTIONALLY LEFT BLANK