

CHAPTER 2 – AURAL/VISUAL INDICATING AND RECORDING

	Page
TABLE OF CONTENTS	02-00
Table of Contents	02-00-1
INTRODUCTION	02-10
Introduction	02-10-1
ENGINE INDICATION AND CREW ALERTING SYSTEM	02-20
Engine Indicating and Crew Alerting System	02-20-1
Display Reversion	02-20-6
Aural Warning	02-20-7
Master Warning / Master Caution Annunciator Lights	02-20-9
Crew Alerting System Messages	02-20-9
EICAS Warning Messages (Red) and Aural	02-20-13
EICAS Cautions Messages (Amber)	02-20-14
EICAS Advisory Messages (Green)	02-20-16
EICAS Status Messages (White)	02-20-17
Warnings That Are Not Inhibited <0039>	02-20-21
Cautions That Are Not Inhibited <0039>	02-20-22
Advisory and Status Information Is Not Inhibited <0039>	02-20-23
Take-Off Configuration Warning	02-20-23
Landing Configuration Warning	02-20-25
Menu Page	02-20-26
System Circuit Breakers	02-20-30
RECORDING	02-30
Recording	02-30-1
System Circuit Breakers	02-30-4
MAINTENANCE DATA COMPUTER	02-40
Maintenance Diagnostic System	02-40-1
Maintenance Menu Page Overview	02-40-3
Data Loader Unit	02-40-4
System Circuit Breakers	02-40-5

LIST OF ILLUSTRATIONS

INTRODUCTION		
Figure 02-10-1	Aural/Visual Indicating and Recording Schematic	02-10-2



**AURAL/VISUAL INDICATING AND
RECORDING
Table of Contents**

Vol. 1

02-00-2

REV 56, Jan 31/03

ENGINE INDICATION AND CREW ALERTING SYSTEM

Figure 02-20-1	Engine Indicating and Crew Alerting System - General	02-20-3
Figure 02-20-2	EICAS Control Panel	02-20-4
Figure 02-20-3	EICAS Miscomparison Indication	02-20-5
Figure 02-20-4	Display Reversion	02-20-6
Figure 02-20-5	Display Selector	02-20-6
Figure 02-20-6	DCU Controls and Indications	02-20-8
Figure 02-20-7	Master Warning / Master Caution Lights	02-20-9
Figure 02-20-8	EICAS Display Message Fields	02-20-12
Figure 02-20-9	Take-Off Configuration Warnings	02-20-24
Figure 02-20-10	Menu Page <0024><0039><0039><0050>	02-20-26

RECORDING

Figure 02-30-1	Recording	02-30-2
Figure 02-30-2	Recording - EICAS Indications	02-30-3

MAINTENANCE DATA COMPUTER

Figure 02-40-1	Maintenance Diagnostic Computer System	02-40-2
Figure 02-40-2	Data Loader Unit <0018>	02-40-4

	AURAL/VISUAL INDICATING AND RECORDING Introduction	Vol. 1	02-10-1
		REV 56, Jan 31/03	

1. INTRODUCTION

The indicating and recording systems consist of components that provide visual and aural indications of system operation, aircraft configurations and to record aircraft information.

Data from the aircraft systems and from each engine is received and processed by two data concentrator units (DCU's) located in the avionics compartment. The DCU's provide information to the engine indication and crew alerting system (EICAS). Master warning and caution lights on the glareshield enhance the indication system. Audio signals are generated within the DCUs and are heard through the flight deck speakers.

Data from the aircraft systems and from each engine is received and processed by three data concentrator units (DCU's) located in the avionics compartment. The DCU's provide information to the engine indication and crew alerting system (EICAS). Master warning and caution lights on the glareshield enhance the indication system. Audio signals are generated within the DCUs and are heard through the flight deck speakers. <0019>

The DCU's also provide interface with the flight data recorder system (FDR), the lamp driver unit (LDU) and the maintenance diagnostic computer (MDC) via the integrated avionic processor system (IAPS).

	Flight Crew Operating Manual CSP A-013	MASTER
--	---	---------------

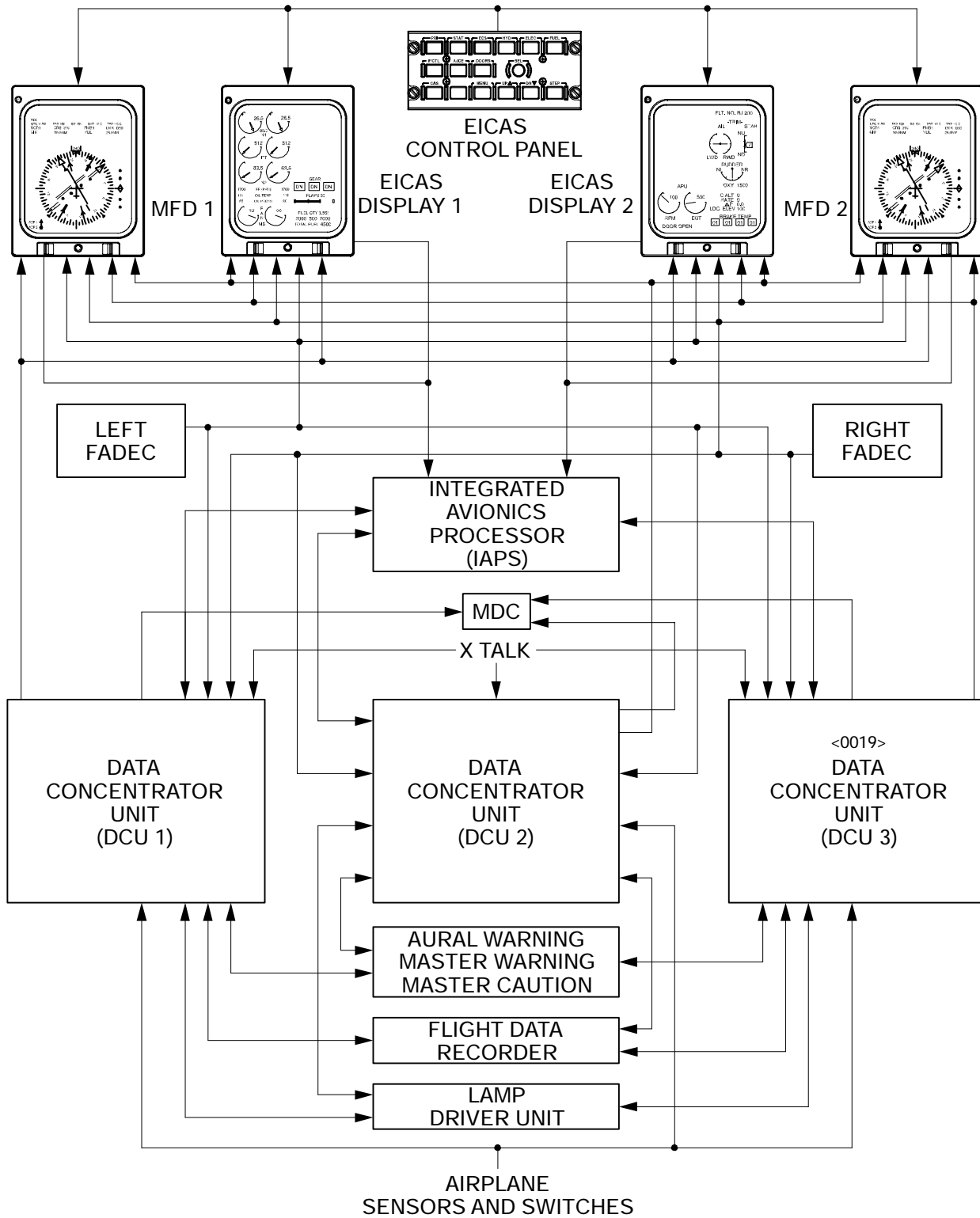

AIRPLANE
SENSORS AND SWITCHES
Aural/Visual Indicating and Recording Schematic <MST>
Figure 02-10-1

	AURAL/VISUAL INDICATING AND RECORDING Engine Indication and Crew Alerting System	Vol. 1	02-20-1
		REV 56, Jan 31/03	

1. ENGINE INDICATING AND CREW ALERTING SYSTEM

The engine indicating and crew alerting system (EICAS) provides the crew with two electronic displays to monitor the engines, control surfaces and all major aircraft systems. The EICAS system also provides the crew with alerting system messages that are posted on the EICAS displays in the form of warning, caution, advisory and status messages. All warning and caution messages will also illuminate the MASTER WARNING or MASTER CAUTION lights on the glareshield. Some crew alerts are also accompanied by aural tones and voice advisories. The EICAS system can also illuminate switchlights on specific system control panels to provide component/system status or to prompt corrective crew action.

The EICAS system consists of the following:

- Two EICAS displays on the center instrument panel - Used to display system information and status.

NOTE

The EICAS displays are referred to as EICAS Display 1 (ED1) and EICAS Display 2 (ED2). ED1 is on the left and ED2 is on the right. The information that is shown on each display is referred to as a page. In normal configuration, the Primary page is shown on ED1 and the Status page is shown on ED2.

- EICAS control panel on the center pedestal - Used to select which EICAS page, (primary page, status page, synoptic pages or menu page) is to be shown on ED2. The panel is also used to display additional caution and status messages on ED1 and ED2.
- Engine/Miscellaneous test panel on the center pedestal - Used to perform tests of the annunciator lights, set annunciator light levels, record specific flight data events and synchronize the engines N1 or N2.
- Display reversion control panels on the pilot's and copilot's side panel - PFD position - puts the primary flight display (PFD) information on the pilot's or copilot's multifunctional display (MFD). EICAS position - makes all EICAS information available on the pilot's or copilot's MFD.
- EICAS selector on the center pedestal SOURCE SELECTOR PANEL - Used to select where the EICAS information will be displayed. The information can be displayed on ED1 and ED2, or all the EICAS information can be displayed on either ED1 or ED2.
- MASTER WARNING and MASTER CAUTION switchlights on the glareshield. - Illuminate when a warning or caution is detected by the data concentrator units (DCU's).
- Lamp driver unit, located in the avionics compartment - Used to control and test flight compartment annunciator lights.
- Data concentrator units located in the avionics compartment - Used to process data and transmit the applicable data to the EICAS displays, flight data recorder and lamp driver units. The DCU's are also used to control the aural warning system.

	Flight Crew Operating Manual CSP A-013	MASTER
--	---	---------------



The EICAS Primary page displays the following information:

- Engine compressor and turbine speeds (N₁ and N₂ rpm)
- Engine temperature (ITT)
- Fuel flow (FF)
- Oil pressure and temperature
- Engine vibration data
- Pressurization data
- Landing gear position
- Flap position
- Fuel tank quantities and total fuel
- Crew alerting system (CAS) messages in the form of red warning and amber caution messages.

The EICAS Status page displays the following information:

- Flight control trim indications
- Auxiliary power unit (APU) indications such as APU RPM, exhaust gas temperature (EGT) and APU inlet door status
- Pressurization data such as cabin altitude, cabin rate of change, cabin pressure differential, and landing field elevation
- Oxygen system pressure
- Brake system temperature readouts
- Aircraft systems synoptic pages (via the EICAS control panel) (The respective synoptic page contents will be covered in the corresponding chapters)
- MENU page (via the EICAS control panel) allows reset of the fuel used indicator
- Crew alert system (CAS) messages in the form of green advisory and white status messages.

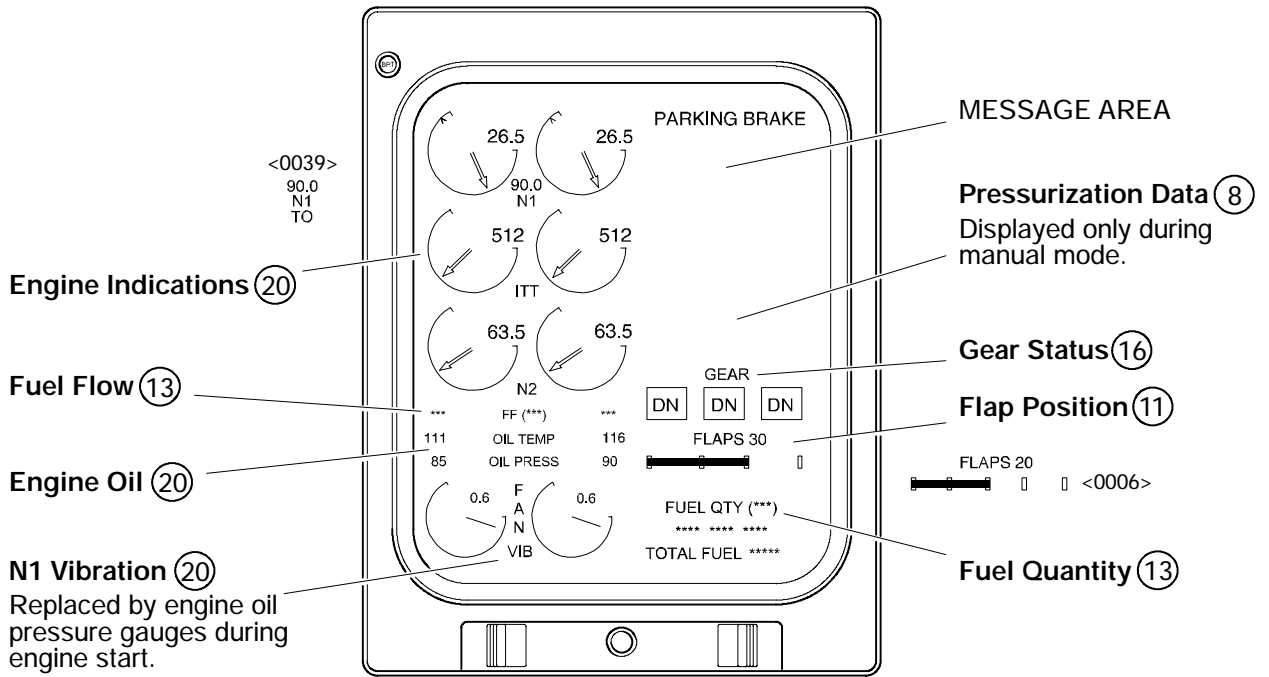

Primary Page

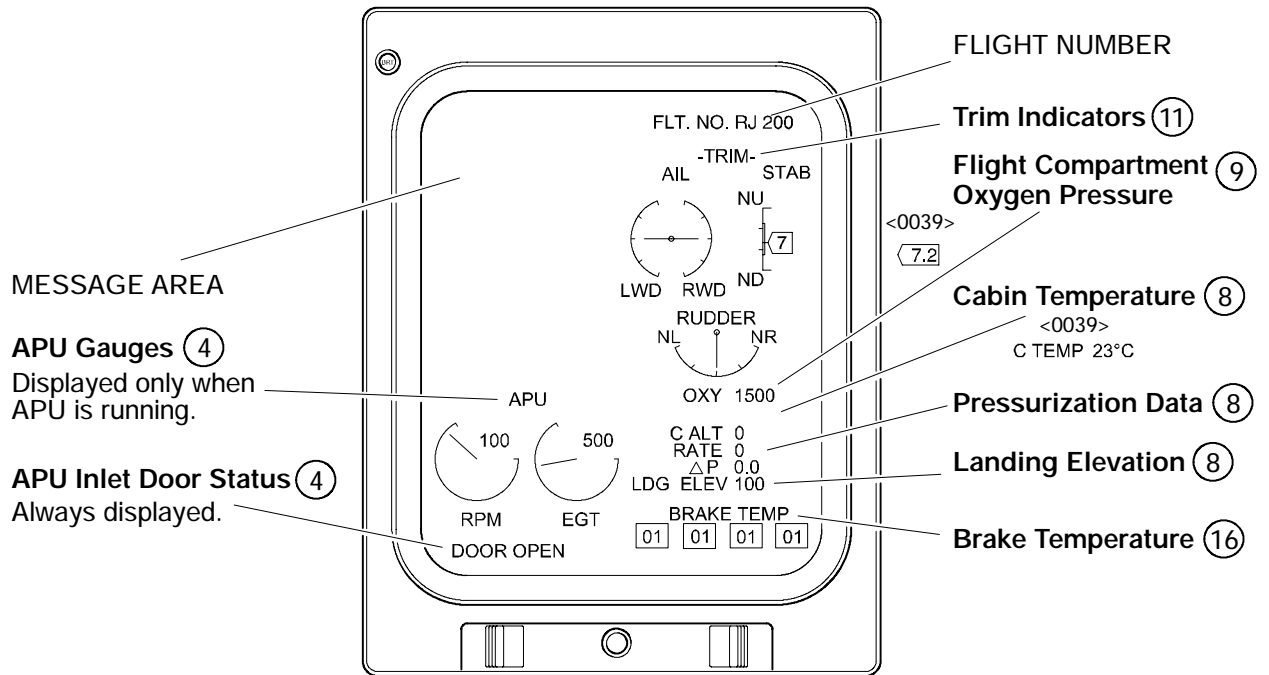

Status Page

○ Indicates Chapter in which information on item may be found.

Engine Indication and Crew Alerting System – General <MST>
Figure 02-20-1

Status Page (STAT)
 Used to display the status page on ED2. A second push will remove status messages from view or will display additional status messages if more messages exist.

Synoptic Pages (ECS, HYD, ELEC, FUEL, F/CTL, A/ICE, DOORS, MENU)
 Used to display system synoptic pages. A second push of the ELEC button will replace the AC electrical synoptic page with the DC electrical synoptic page.

Primary Page (PRI)
 Used to displays the primary page on ED2.

Select (SEL)
 Used to activate a selected item on the menu page. Cursor symbol, letter or number will change color to acknowledge selection.

Crew Alerting System (CAS)
 Used when primary page is displayed to remove caution messages from view or display additional caution messages if more messages exist.

STEP
 Used to sequentially step through the pages on ED2.

UP and DN
 Used to control operation of the cursor on menu page. The buttons slew the value of selected items.

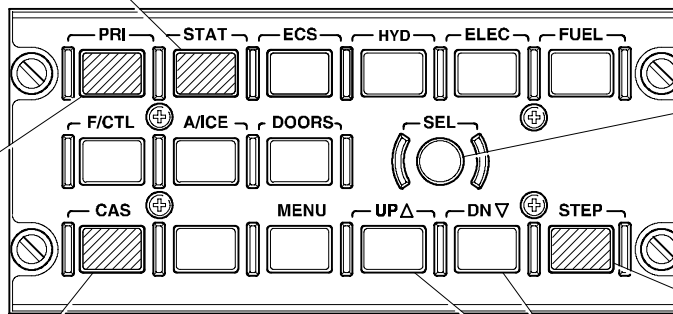

**EICAS Control Panel
Center Pedestal**

Indicates controls operable during a panel failure.

EICAS Control Panel
Figure 02-20-2

CAS MISCOMP status (white)
Indicates that a miscomparison of detected warning, caution or aural alerts exists between DCUs.

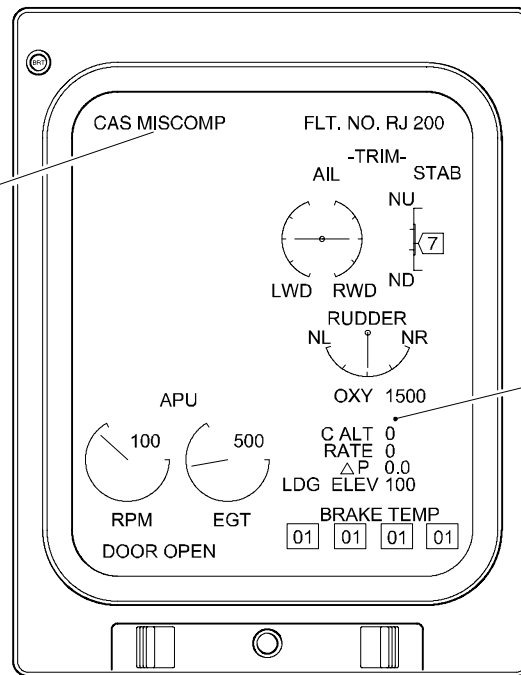

<0039>
7.2

<0039>
C TEMP 23°C

Status Page

EICAS Miscomparison Indication <MST>
Figure 02-20-3

A. Display Reversion

If EICAS display 1 (ED1) fails, the primary page will be automatically displayed on ED2. If ED2 fails, there is no automatic transfer to ED1. With either display failure, the EICAS control panel is rendered inoperative. To regain control, the EICAS selector on the SOURCE SELECTOR PANEL must be set to the operable display (ED1 or ED2) to re-establish the EICAS control panel functions. The selector also makes available all EICAS information on the selected display.

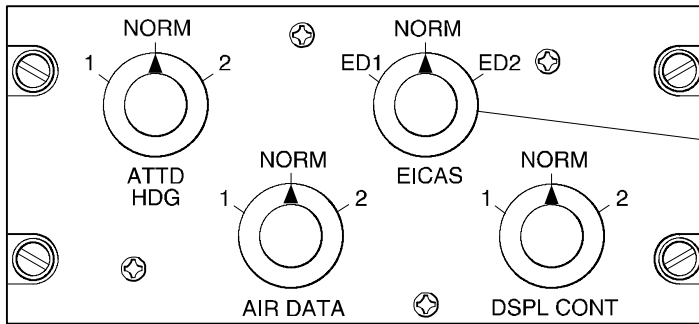

EICAS
 Used to establish EICAS control panel functions on a selected display.

- NORM - EICAS operates normally with both ED1 and ED2.
- ED1 - Enables EICAS control panel functions on primary display and disables secondary display.
- ED2 - Enables EICAS control panel functions on secondary display and disables primary display.

**Source Selector Panel
Center Pedestal**

**Display Reversion
Figure 02-20-4**

To ensure timely access to essential EICAS data, all EICAS pages can be made available on either MFD by selecting the EICAS position on the respective Display Reversionary Panel.

Display Selector

Used to change the pilot or copilot MFD display to an EICAS display.

- EICAS - The MFD displays the EICAS status page.
 All other EICAS pages are available using the EICAS control panel.

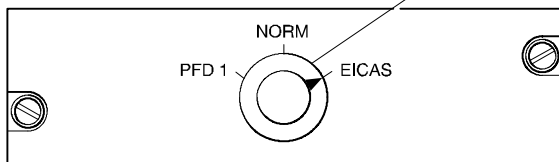

**Pilot's Display Reversionary Panel
Pilot's Side Panel**

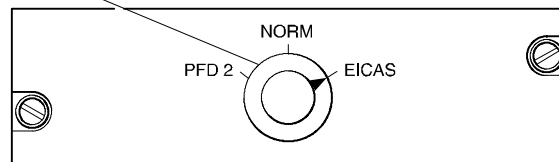

**Copilot's Display Reversionary Panel
Copilot's Side Panel**

**Display Selector
Figure 02-20-5**

B. Aural Warning

Various tones call attention to warnings. There are ten types of aural alerts:

Sound	Indication	Chapter Reference
Warbler	Stall	Chapter 11, Flight Controls
Siren	Windshear	Chapter 18, Navigation
Whoop - Whoop	GPWS mode 1 or 2 (excessive descent rate or excessive closure rate)	Chapter 18, Navigation
Fire Bell	Fire warnings	Chapter 10, Fire Protection
Clacker	<ol style="list-style-type: none"> 1. Excessive stabilizer trim movement 2. V_{MO}/M_{MO} exceedance 3. Airspeed too high for current flap setting 	Chapter 11, Flight Controls Chapter 12, Flight Instruments
Cavalry Charge	Autopilot disconnect	Chapter 3, Automatic Flight Control System
Horn	Gear not down	Chapter 16, Landing Gear
Triple chime	Warning tone that precedes an aircraft system voice advisory	Chapters 2 through 20
C-chord	Altitude alert	Chapter 12, Flight Instruments
Single chime	Caution tone that precedes an aircraft system voice advisory	Chapters 2 through 20

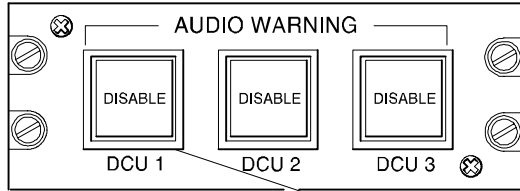

<0019>

**Audio Warning Panel
Copilot's Side Console**

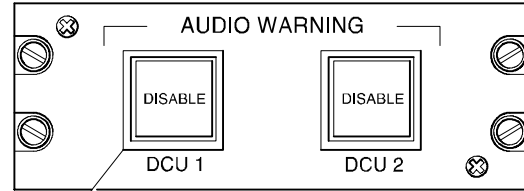

**Audio Warning Panel
Copilot's Side Console**

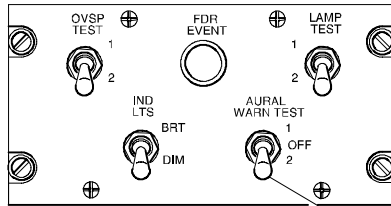

**Miscellaneous Test Panel
Center Pedestal**

DCU 1, DCU 2, and DCU 3 (Guarded) <0019>
DCU 1 and DCU 2 (Guarded)
 Used to disable and silence the aural warnings of a faulty DCU.

- **DISABLE (white) light** indicates respective DCU aural output is disabled.

Aural Warning Test Switch (alternate action)

- 1 - Tests all aural alerts within data concentrator unit 1.
- OFF - Disable aural alert test.
- 2 - Tests all aural alerts within data concentrator unit 2.

<0019> **NOTE**

- To test DCU 3:
 - Disable DCU 1.
 - Set test switch to DCU 1.

DCU 1, 2, or 3 INOP status (white) <0019>
DCU 1 or 2 INOP status (white)
 Indicates internal fault or crosstalk fault in respective data concentrator unit.

- <0019>
- DCU 1 INOP
 - DCU 2 INOP
 - DCU 3 INOP
 - DCU 1 AURAL INOP
 - DCU 3 AURAL INOP

DCU 1, 2, or 3 AURAL INOP status (white) <0019>
DCU 1 or 2 AURAL INOP status (white)
 Indicates internal aural fault in respective data concentrator unit or indicates respective DCU aural output has been disabled.

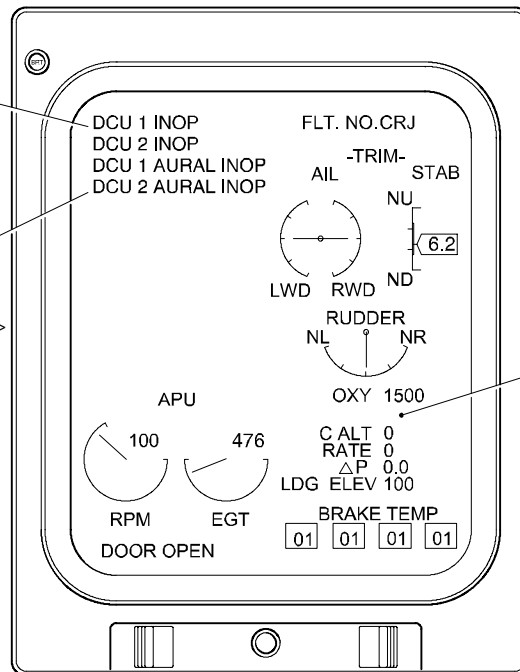

<0039>

<0039>

C TEMP 23°C

Status Page

DCU Controls and Indications <MST>
Figure 02-20-6

	AURAL/VISUAL INDICATING AND RECORDING Engine Indication and Crew Alerting System	Vol. 1	02-20-9
		REV 56, Jan 31/03	

C. Master Warning / Master Caution Annunciator Lights

(1) Master Warning Annunciator Lights

The red MASTER WARNING push-button annunciator (PBA) lights are installed on the left and right glareshield panels. Both lights will come on flashing when any warning occurs. Pushing either MASTER WARNING PBA will extinguishes both MASTER WARNING lights for the duration of that warning and resets the lights for future warnings. The warning message on the EICAS primary page will remain on as long as the warning exists.

Pushing the MASTER WARNING PBA also silences the aural warnings except for the following cases:

- Stall warbler
- GPWS/TCAS (voices and aural)
- Overspeed clacker
- Flap clacker
- Stabilizer trim clacker
- AP Disconnect cavalry charge
- Configuration warnings
- Gear Horn

(2) Master Caution Annunciator Lights

The amber MASTER CAUTION push-button annunciator (PBA) lights are installed on the left and right glareshield panels. Both lights will come on flashing when any caution occurs. Pushing either MASTER CAUTION PBA will extinguishes both MASTER CAUTION lights for the duration of that caution and resets the lights for future cautions.

Pushing the MASTER CAUTION PBA will not silence the following:

- GPWS and TCAS voice alerts
- Altitude alert (C-chord) aural

	Flight Crew Operating Manual CSP A-013	MASTER
--	---	---------------

MASTER WARNING

Both lights come on (red) in conjunction with warning lights and EICAS messages. Pushing either switch will turn both lights out and reset warning system for subsequent indications. Lights cannot be dimmed.

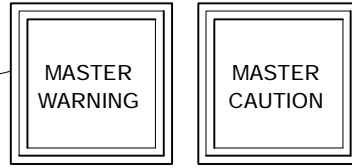

Left and Right Glareshield

MASTER CAUTION

Both lights come on (amber) in conjunction with caution lights and EICAS messages. Pushing either switch will turn both lights out and reset caution system for subsequent indications. Lights cannot be dimmed.

Master Warning / Master Caution Lights
Figure 02-20-7

D. Crew Alerting System Messages

Crew alerting system messages appear in the message area on both EICAS displays (ED1 and ED2). The messages are arranged by their urgency and order of occurrence. All crew alerting system messages are divided into one of four categories: warnings, cautions, advisories, or status.

- Warnings messages, are the most urgent type of crew alerts and indicate operational or aircraft system conditions that require immediate corrective action. All warning messages are preceded by a triple chime and appear in red at the top of the message area on ED1. For all warnings, the red MASTER WARNING lights will flash. Some warnings also have an aural alert consisting of a unique tone and a voice advisory. Warning messages cannot be removed from view, unless the applicable failure has been rectified.
- Cautions messages, are less urgent than warnings and indicate operational or aircraft system conditions that require prompt corrective action. All caution messages are preceded by a single chime and appear in amber immediately below the warnings in the message area on ED1. For all cautions, the amber MASTER CAUTION lights will flash. Caution messages can be removed from view by using the CAS button on the EICAS control panel.
- Advisories messages, are used to show that a safe condition exists. They appear in green at the top of the message area on ED2. Advisory messages cannot be removed from view, unless the applicable system or switch has been deactivated or deselected.
- Status messages, indicate that an abnormal condition exists or that a low-priority failure has occurred. They appear in white in the message area below the advisories. Status messages can be removed from view by using the STAT button on the EICAS control panel.

	AURAL/VISUAL INDICATING AND RECORDING Engine Indication and Crew Alerting System	Vol. 1	02-20-11
		REV 56, Jan 31/03	

The most recent message appears at the top of its respective group of messages. A message is automatically removed from EICAS when the associated condition no longer exists. In this case, messages which appeared below the deleted message, each move up one line. When a new fault occurs, the new message will move older messages down one line.

If the number of warnings exceeds the message area (number of lines), then only the most recent warning messages are displayed and a red PAGE 1/2 appears at the bottom of the message area.

When more caution messages exist than can fit in the message area, a second page of cautions will be created. The second page of cautions will be indicated as Page 1 of 2 in the top RH corner of ED1. The CAS button on the EICAS control panel is used to page through the caution messages.

- Caution messages can be removed from view by pressing the CAS button, providing that both main generators are operating and on-line. A MSGS icon will appear, advising the crew that the caution messages are out of view.

NOTE

If a new abnormal situation occurs, the corresponding caution message will appear. To view all of the caution messages, re-select the CAS button.

Advisory messages cannot be removed from view, unless the appropriate system/switch, has been deactivated. If the number of advisories exceeds the message area, a green PAGE 1/2 appears at the bottom of the message area.

When more status messages exist than can fit in the message area, a second page of status messages will be created. The second page of status messages will be indicated as Page 1 of 2 in the top LH corner of ED2. The STAT button on the EICAS control panel is used to page through the status messages.

- Status messages can be removed from view, anytime the EICAS system is powered, by pressing the STAT button on the EICAS control panel. A MSGS icon will appear, advising the crew that status messages are out of view.

	Flight Crew Operating Manual CSP A-013	MASTER
--	---	---------------

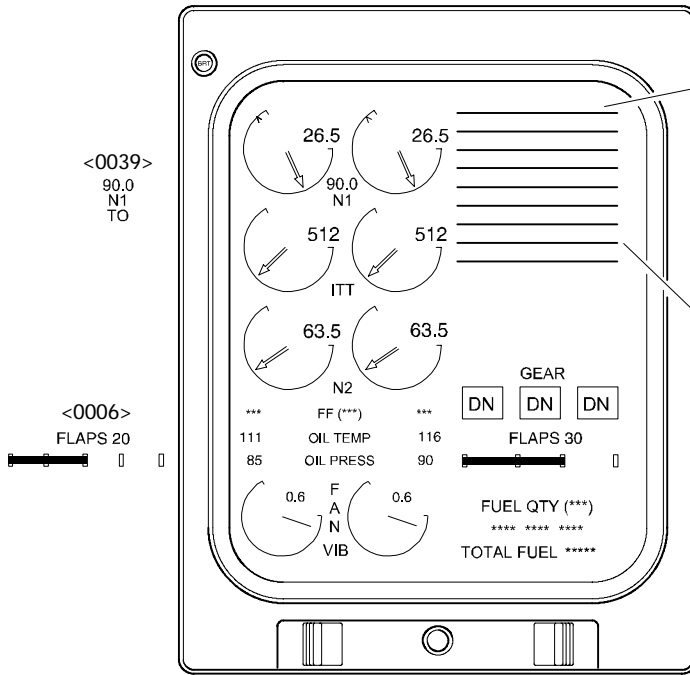

Primary Page

Warning Messages (red)

Conditions that require immediate corrective action.

Warning messages cannot be paged.

If the number of warning messages exceeds the available message area, only the most recent will be displayed.

Warning messages cannot be removed from view, without rectifying the failure.

Caution Messages (amber)

Conditions that require prompt corrective action.

Caution messages can be paged.

Caution messages can be removed from view, providing both main generators are operating and on-line.

Advisory Messages (green)

System response or acknowledgement messages (new condition).

Advisory messages cannot be paged.

Advisory messages cannot be removed from view, without de-selecting the appropriate system.

Status Messages (white)

Conditions that require time available corrective action.

Status messages can be paged.

Status messages can be removed from view anytime.

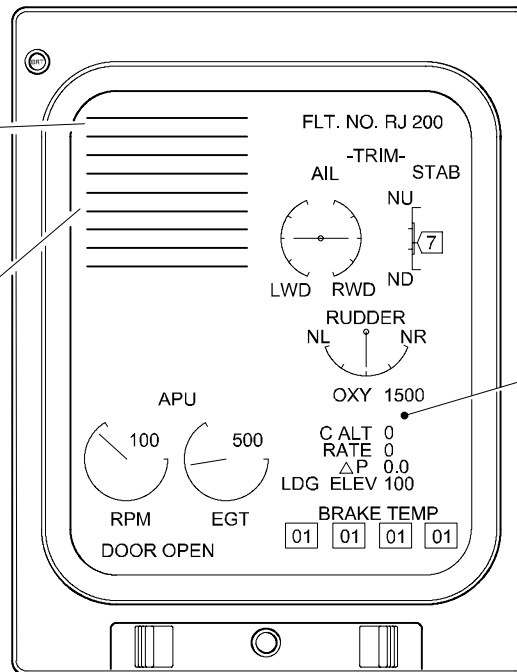

Status Page

EICAS Display Message Fields <MST>
Figure 02-20-8



E. EICAS Warning Messages (Red) and Aural

Message	Aural	Chapter
AFCS MSG FAIL		3
ANTI-ICE DUCT	Anti-Ice Duct	19
APU FIRE	☆	10
APU OVERSPEED	APU	4
APU OVERTEMP	APU	4
BRAKE OVHT	Brakes	16
CABIN ALT	Cabin Pressure	8
CONFIG AILERON	Config Trim	2
CONFIG AP	Config Autopilot	2
CONFIG FLAPS	Config Flaps	2
CONFIG RUDDER	Config Trim	2
CONFIG SPLRS	Config Spoilers	2
CONFIG STAB	Config Trim	2
DIFF PRESS	Cabin Pressure	8
EMER PWR ONLY		7
ENGINE OVERSPD	<0039>	20
GEAR DISAGREE	Gear Disagree	16
ICE		15
ICE	ICE <0022>	15
L 10TH DUCT	Bleed Air Duct	19
L 14TH DUCT	Bleed Air Duct	19
L ENG FIRE	Firebell	10
L ENG OIL PRESS	Engine Oil	20
L ENG OIL PRESS	<0039>	20
L JETPIPE OVHT	Jetpipe Overheat	20
MLG BAY OVHT	Gear Bay Overheat	10
NOSE DOOR OPEN	Nose Door	16
PARKING BRAKE	Config Brakes	16
PASSENGER DOOR	Door	6
R 10TH DUCT	Bleed Air Duct	19
R 14TH DUCT	Bleed Air Duct	19
R ENG FIRE	Firebell	10
R ENG OIL PRESS	Engine Oil	20
R ENG OIL PRESS	<0039>	20
R JETPIPE OVHT	Jetpipe Overheat	20
SMOKE CARGO	Smoke	10
SMOKE TOILET		10
WING OVHT	Wing Overheat	15



F. EICAS Caution Messages (Amber)

Message	Ch.	Message	Ch.	Message	Ch.	Message	Ch.
A/SKID INBD	16	EFIS COMP INOP	2	L REV UNSAFE	20	WING A/I SNSR	15
A/SKID OUTBD	16	EFIS COMP MON	2	L SCAV EJECTOR	13	WOW INPUT	16
AC 1 AUTOXFER	7	EICAS COMP INOP	2	L SPOILERON	11	WOW OUTPUT	16
AC 2 AUTOXFER	7	ELT ON	5	L STATIC HEAT	15	XFLOW APU PUMP	13
AC BUS 1	7	EMERG DEPRESS	8	L WINDOW HEAT	15	YAW DAMPER	11
AC BUS 2	7	EMER LTS OFF	17	L WING A/I	15		
		ENG BTL 1 LO	10	L WSHLD HEAT	15		
		ENG BTL 2 LO	10	L XFER SOV	13		
		ESS TRU 1	7	L XFLOW SOV	13		
		ESS TRU 2	7	MACH TRIM	11		
AC ESS BUS	7	FLAPS FAIL	11	MAIN BATT CHRG	7		
AC SERV BUS	7	FLT SPLR DEPLOY	11	MAIN BATT OFF	7		
		FLT SPLRS	11	MLG OVHT FAIL	16		
AP PITCH TRIM	3	FUEL CH 1/2 FAIL	13	NO STRTR CUTOUT	20		
		<0039>					
AP TRIM IS LWD	3	FUEL IMBALANCE	13	OB BRAKE PRESS	16		
AP TRIM IS ND	3	GEN 1 OFF	7	OB GND SPLRS	11		
AP TRIM IS NU	3	GEN 1 OVLD	7	OVBD COOL	8		
AP TRIM IS RWD	3	GEN 2 OFF	7	OXY LO PRESS	9		
APR CMD SET	20	GEN 2 OVLD	7	PARK BRAKE SOV	16		
APR INOP	20	GLD NOT ARMED	11	PASS OXY ON	9		
APU BATT CHGR	7	GLD UNSAFE	11	PAX DR LATCH	6		
APU BATT OFF	7	GND SPLR DEPLOY	11	PAX DR OUT HNDL	6		
APU BLEED ON	19	HYD 1 HI TEMP	14	PAX DR STOW	6		
APU BTL LO	10	HYD 1 LO PRESS	14	PITOT BASE HEAT	15		
APU FAULT	4	HYD 2 HI TEMP	14	PROX SYS CHAN	16		
				<0039>			
APU FIRE FAIL	10	HYD 2 LO PRESS	14	R AOA HEAT	15		
APU GEN OFF	7	HYD 3 HI TEMP	14	R COWL A/I	15		
APU GEN OVLD	7	HYD 3 LO PRESS	14	R EMER DOOR	6		
APU LCV FAIL	19	HYD EDP 1A	14	R ENG MISCOMP	19		
APU OIL PRESS	4	HYD EDP 2A	14	R ENG SOV CLSD	13		
APU SOV FAIL	13	HYD PUMP 1B	14	R ENG SOV FAIL	13		
APU SOV OPEN	13	HYD PUMP 2B	14	R ENG SOV OPEN	13		
ARINC COOL	8	HYD PUMP 3A	14	R FIRE FAIL	10		
AUTO PRESS	8	HYD PUMP 3B	14	R FLT SPLR	11		
AV BAY DOOR	6	HYD SOV 1 OPEN	14	R FUEL FILTER	13		
BATTERY BUS	7	HYD SOV 2 OPEN	14	R FUEL LO PRESS	13		
BLEED MISCONFIG	19	IB BRAKE PRESS	16	R FUEL LO TEMP	13		
		<0039>					
BULK FUEL TEMP	13	IB GND SPLRS	11	R FUEL PUMP	13		
CABIN ALT	8	ICE <0039>	15	R JET OVHT FAIL	10		
CARGO BTL LO	10	ICE DET FAIL	15	R MAIN EJECTOR	13		
CARGO DOOR	6	IDG 1	7	R PACK HI PRESS	8		



**AURAL/VISUAL INDICATING AND
RECORDING
Engine Indication and Crew Alerting System**

Vol. 1	02-20-15
REV 56, Jan 31/03	

Message	Ch.	Message	Ch.	Message	Ch.	Message	Ch.
CARGO OVHT	8	IDG 2	7	R PACK HI TEMP	8		
DC BUS 1	7	L AOA HEAT	15	R PITOT HEAT	15		
DC BUS 2	7	L COWL A/I	15	R REV UNLOCKED	20		
DC EMER BUS	7	L EMER DOOR	6	R REV UNSAFE	20		
DC ESS BUS	7	L ENG MISCAMP	19	R SCAV EJECTOR	13		
DC SERV BUS	7	L ENG SOV CLSD	13	R SPOILERON	11		
DISPLAY COOL	8	L ENG SOV FAIL	13	R STATIC HEAT	15		
BULK FUEL TEMP	13	L ENG SOV OPEN	13	R WINDOW HEAT	15		
CABIN ALT	8	L FIRE FAIL	10	R WING A/I	15		
CARGO BTL LO	10	L FLT SPLR	11	R WSHLD HEAT	15		
		L FUEL FILTER	13	R XFER SOV	13		
DC BUS 1	7	L FUEL LO PRESS	13	R XFLOW SOV	13		
DC BUS 2	7	L FUEL LO TEMP	13	SERVICE DOOR	6		
DC EMER BUS	7	L FUEL PUMP	13	SMOKE TOILET	10		
DC ESS BUS	7	L JET OVHT FAIL	10	SPOILERONS ROLL	11		
DC SERV BUS	7	L MAIN EJECTOR	13	STAB TRIM	11		
DISPLAY COOL	8	L PACK HI PRESS	8	STALL FAIL	11		
EFIS COMP INOP	12	L PACK HI TEMP	8	STBY PITOT HEAT	15		
EFIS COMP MON	12	L PITOT HEAT	15	STEERING INOP	16		
ELEVATOR SPLIT	11	L REV UNLOCKED	20	TAT PROBE HEAT	15		



G. EICAS Advisory Messages (Green)

Message	Chapter
APR ARM	20
APR TEST 1 OK	20
APR TEST 2 OK	20
APR TEST 3 OK <0019>	20
APU SOV CLSD	13
APU SQUIB 1	10
APU SQUIB 2	10
CARGO SQUIB 1	10
CARGO SQUIB 2	10
COWL A/ICE ON <0039>	15
CPLT ROLL CMD	11
DUCT TEST OK	19
FDR EVENT	2
FLT SPLR DEPLOY	11
GLD MAN ARM	11
GND SPLR DEPLOY	11
GRAV XFLOW OPEN	13
HYD SOV 1 CLOSED	14
HYD SOV 2 CLOSED	14
ICE <0039>	15
IGNITION A/B	20
IGNITION A <0039>	20
IGNITION B <0039>	20
L COWL A/I ON <0039>	15
L ENG SOV CLSD	13
L ENG SQUIB 1	10
L ENG SQUIB 2	10
L FUEL PUMP ON	13
L REV ARMED	20
PARKING BRAKE ON	16
PLT ROLL CMD	11
R COWL A/I ON <0039>	15
R ENG SOV CLSD	13
R ENG SQUIB 1	10
R ENG SQUIB 2	10
R FUEL PUMP ON	13
R REV ARMED	20
SELCAL HF Selcal <0010><0011>5	
SELCAL HF 1 Selcal <0010><0060> 5	
SELCAL HF 2 Selcal <0010><0060> 5	
SELCAL VHF 1 Selcal <0010> 5	
SELCAL VHF 2 Selcal <0010> 5	
SELCAL VHF 3 Selcal <0010>> 5	
T/O CONFIG OK	2
WING A/ICE OK	15
WING A/ICE ON <0039>	15
WING/COWL A/I ON <0039>	15



H. EICAS Status Messages (White)

Message	Ch.	Message	Ch.	Message	Ch.
10TH ISOL OPEN	19			L 10TH ARM OPEN <0039>	19
14TH ISOL OPEN	19	DUCT MON LOOP A	19	L 10TH SOV CLSD	19
AC 1 AUTOXFER OFF	7	DUCT MON LOOP B	19	L 14TH ARM OPEN <0039>	19
AC 2 AUTOXFER OFF	7	EMER LTS ON	17	L 14TH SOV CLSD	19
AC ESS ALTN	7	ENG TYPE MISCOMP	20	L APR ECU FAIL <0039>	20
AC UTIL 1 OFF	7	FD 1 FAIL	3	L AUTO XFLOW ON	13
AC UTIL 2 OFF	7	FD 2 FAIL	3	L ENG ECU FAIL	19
APU BATT CHGR <0039>	7	FDR ACCEL FAIL	2	L ENGINE START	20
APU ECU FAIL	4	FDR FAIL	2	L PACK OFF	8
APU IN BITE	4	Post SB 601R-27-116 FLAPS DEGRADED <0039>	11	L XFLOW ON	13
APU LCV OPEN	19	FLAPS HALFSPEED	11	MAIN BATT CHGR <0039>	7
APU SOV OPEN	13	FLT SPLRS FAULT	11	MAN XFLOW	13
APU START	4	FLUTTER DAMP FAIL	11	NO SMOKING	17
AUTO PRESS 1 FAIL	8	FUEL CH 1 FAIL	13	OB GND SPLR FAULT	11
AUTO PRESS 2 FAIL	8	FUEL CH 2 FAIL	13	OVBD COOL FAIL	8
AUTO XFLOW INHIB	13	GLD MAN DISARM	11	PROX SYS FAULT	16
BTMU FAIL	16	GPWS FAIL	18	R 10TH ARM OPEN <0039>	8
CABIN PRESS MAN	8	GRAV XFLOW FAIL	13	R 10TH SOV CLSD	8
CABIN TEMP MAN	8	GS CANCEL	18	R 14TH ARM OPEN <0039>	8
CARGO FAN FAIL	8	HGS FAIL <0026>	18	R 14TH SOV CLSD	8
CARGO SOV FAIL	8	HORN MUTED	16	R APR ECU FAIL <0039>	20
CAS MISCOMP	2	IAPS DEGRADED	3	R AUTO XFLOW ON	13
CKPT COOL FAIL	8	IAPS OVERTEMP	3	R ENG ECU FAIL	19
CKPT TEMP MAN	8	IB GND SPLR FAULT	11	R ENGINE START	20
CONT IGNITION	20	ICE	15	R PACK OFF	8
COOL EXHAUST FAIL	8	ICE DET 1 FAIL	15	R XFLOW ON	13
CPAM FAIL	8	ICE DET 2 FAIL	15	RAM AIR OPEN	8
DC ESS TIE CLSD	7	IDG 1 DISC	7	SEAT BELTS	17
DC TIE 1 CLSD	7	IDG 2 DISC	7	SPEED REFS INDEP	3
DC TIE 2 CLSD	7	IGNITION A/B	20	SPOILERONS FAULT	11
DCU 1 APR FAIL	2	INBD COOL FAIL	8	STAB CH 1 INOP	11
DCU 2 APR FAIL	2	IRS 1 DC FAIL <0025>	12	STAB CH 2 INOP	11
DCU 3 APR FAIL <0019>	2	IRS 1 IN ATT <0025>	12	TERRAIN OFF <0039>	18



Message	Ch.	Message	Ch.	Message	Ch.
DCU 1 AURAL INOP	2	IRS 1 ON BATT <0025>	12	TERRAIN FAIL <0039>	18
DCU 2 AURAL INOP	2	IRS 1 OVERTEMP <0025>	12	TERRAIN NOT AVAIL <0039>	18
DCU 3 AURAL INOP <0019>	2	IRS 2 DC FAIL <0025>	12	WINDSHEAR FAIL	18
DCU 1 INOP	2	IRS 2 IN ATT <0025>	12	WOW OUTPUT FAIL	7
DCU 2 INOP	2	IRS 2 ON BATT <0025>	12	YD 1 INOP	11
DCU 3 INOP <0019>	2	IRS 2 OVERTEMP <0025>	12	YD 2 INOP	11

I. Inhibits

During take-off and landing, the DCUs will process inhibit logic to minimize spurious or distracting messages.

During take-off, the caution messages are inhibited when:

- The left and right engine N₁ is greater than 79% with weight-on-wheels.

The caution message inhibit is removed when:

- Left and right engine N₁ is less than 67.6%, or
- Radio altitude is greater than 400 ft AGL with the landing gear extended, or
- 30 seconds after ground to air transition.

During landing, the caution messages are inhibited when:

- Radio altitude is less than 400 ft AGL with the landing gear extended.

The caution message inhibit is removed:

- 30 seconds after air to ground transition.



The following caution messages and their corresponding switchlights (if applicable) are not inhibited during take-off and/or landing.

AIRCRAFT SYSTEM	CAUTION MESSAGE (Not Inhibited)
Power Plant	APR INOP L (R) REV UNLOCKED L (R) REV UNSAFE
Automatic Flight Control System	AP TRIM LWD (RWD) (ND) (NU) AP PITCH TRIM YAW DAMPER
Fire Protection	APU BTL LO ENG BTL 1 (2) LO
Flight Controls	FLAPS FAIL FLT SPLR DEPLOY FLT SPLRS L (R) FLT SPLR IB (OB) GND SPLR GLD NOT ARMED GLD UNSAFE GND SPLR DEPLOY L (R) SPOILERON SPOILERONS SPOILERONS ROLL STAB TRIM
Fuel	L (R) FUEL LO PRESS
Hydraulic Power	HYD 1 (2) (3) LO PRESS
Instruments	EFIS COMP MON
Landing Gear	A/SKID INBD (OUTBD) IB/OB BRAKE PRESS STEERING INOP WOW INPUT (OUTPUT)
Miscellaneous	SMOKE TOILET

J. Inhibits <0039>

During the initial take-off, final take-off and landing phases, the DCU's will process inhibit logic to minimize intermittent or distracting warning or caution messages.

	Flight Crew Operating Manual CSP A-013	MASTER
--	---	---------------



(1) Initial Take-off Phase

The initial take-off inhibits are enabled when:

- Left and right engine N_1 is greater than 79%,
- Weight-on-wheels, and
- Airspeed is less than 100 knots.

The initial take-off inhibit is removed when:

- Left and right engine N_1 is less than 67.6%, or
- Aircraft is in the final take-off phase.

(2) Final Take-off Phase

The final take-off inhibits are enabled when:

- Left and right engine N_1 is greater than 79%, and
- Airspeed transitions to greater than 100 knots.

The final take-off inhibit is removed when:

- Left and right engine N_1 is less than 67.6%, or
- Radio altitude is greater than 400 ft AGL, or
- 30 seconds after ground to air transition.

(3) Landing Phase

Landing phase inhibits are enabled when:

- Radio altitude transitions to less than 400 ft AGL, and
- Landing gear down and locked.

The landing phase inhibit is removed when:

- 30 seconds after air to ground transition or
- Radio altitude is less than 400 ft AGL for 3 seconds.

K. Warnings That Are Not Inhibited <0039>

The following warning messages, their corresponding switchlights and aural are not inhibited during initial take-off and/or landing:

Aircraft System	Warning Message (NOT Inhibited)	Aural (NOT Inhibited)
Air-Conditioning and Pressurization	L (R) 10TH DUCT	BLEED AIR DUCT
Aural/Visual Warning System	CONFIG AILERON CONFIG AP CONFIG FLAPS CONFIG RUDDER CONFIG SPLRS CONFIG STAB PARKING BRAKE	CONFIG TRIM CONFIG AUTOPILOT CONFIG FLAPS CONFIG TRIM CONFIG SPOILERS CONFIG STAB CONFIG BRAKES
Automatic Flight Control System		Autopilot Cavalry Charge Altitude C-Chord
Auxiliary Power Unit	APU OVERTEMP	APU
Fire Protection	APU FIRE L (R) ENG FIRE SMOKE CARGO SMOKE TOILET <0037>	Firebell Firebell SMOKE SMOKE
Flight Controls		Stall Warbler Overspeed Clacker Trim Clacker
Ice and Rain Protection	14TH DUCT ANTI-ICE DUCT WING OVERHEAT	BLEED AIR DUCT (anti-ice duct inhibited) WING OVERHEAT
Landing Gear	BRAKE OVERHEAT MLG BAY OVERHEAT	BRAKES GEAR BAY OVERHEAT
Navigation Systems		TCAS Advisories
Power Plant	ENGINE OVERSPD L (R) JETPIPE OVERHEAT	NOTE: - no aural JETPIPE OVERHEAT



L. Cautions That Are Not Inhibited <0039>

The following caution messages, their corresponding switchlights (if applicable) are not inhibited during take-off and/or landing:

AIRCRAFT SYSTEM	CAUTION MESSAGE (Not Inhibited)
Automatic Flight Control System	AP TRIM IS LWD (RWD) (NU) (ND) AP PITCH TRIM YAW DAMPER
Fire Protection	SMOKE TOILET
Flight Controls	FLT SPLR DEPLOY IB (OB) GND SPLRS GLD NOT ARMED GLD UNSAFE GND SPLR DEPLOY L (R) SPOILERONS SPOILERONS ROLL STAB TRIM STALL FAIL
Flight Instruments	EFIS COMP MON
Hydraulic Power	HYD 1 (2) (3) LO PRESS
Ice and Rain protection	ICE ICE DET FAIL L (R) WING A/ICE
Landing Gear	A/SKID INBD (OUTBD) IB/OB BRAKE PRESS WOW INPUT (OUTPUT)
Power Plant	APR INOP L (R) REVERSER UNLOCKED L (R) REVERSER UNSAFE

M. Advisory and Status Information Is Not Inhibited<0039>

All advisory and status messages and their corresponding switchlights (if applicable) are not inhibited during take-off and/or landing.

N. Take-Off Configuration Warning

Take-off configuration warnings are armed when the aircraft is on the ground and both engines are accelerated towards take-off thrust (N_1 greater than 70%).

- If the aircraft is in a safe takeoff configuration, a T/O CONFIG OK advisory (green) message comes on. The message will go out upon aircraft rotation.
- If the aircraft is in an unsafe configuration, configuration aural and warning (red) messages, as well as both MASTER WARNING switchlights come on.

The following systems / conditions are checked:

Condition	Voice Message	EICAS Message
Autopilot engaged	Config Autopilot	CONFIG AP
Flaps not in take-off position	Config Flaps	CONFIG FLAPS
All spoilers not in take-off position (down)	Config Spoilers	CONFIG SPLRS
Horizontal stabilizer outside of take-off range ("green band")	Config Trim	CONFIG STAB
Parking brake set (brake valve closed)	Config Brakes	PARKING BRAKE
Rudder trim outside of take-off range (trim > ± 0.5 degrees)	Config Trim	CONFIG RUDDER
Aileron trim outside of take-off range (trim > ± 0.5 degrees)	Config Trim	CONFIG AILERON

NOTE

All configuration warning indications are cancelled when the configuration error is corrected.

CONFIG AP warning (red)

Indicates that the autopilot is engaged with the airplane configured for take-off.



CONFIG AUTOPILOT

CONFIG AILERON warning (red)

Indicates that aileron trim is outside of the take-off range.



CONFIG TRIM

CONFIG FLAPS warning (red)

Indicates that flaps are not in a take-off position with the airplane configured for take-off.

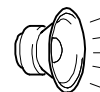

CONFIG FLAPS

CONFIG RUDDER warning (red)

Indicates that rudder trim is outside of the take-off range.

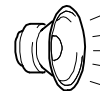

CONFIG TRIM

CONFIG SPLRS warning (red)

Indicates that flight spoilers are not retracted with the airplane configured for take-off.

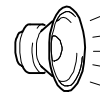

CONFIG SPOILERS

CONFIG STAB warning (red)

Indicates that the horizontal stab trim is outside of the take-off range.

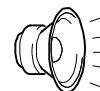

CONFIG TRIM

PARKING BRAKE warning (red)

Indicates that the parking brake is set with the airplane configured for take-off.

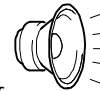

CONFIG BRAKES

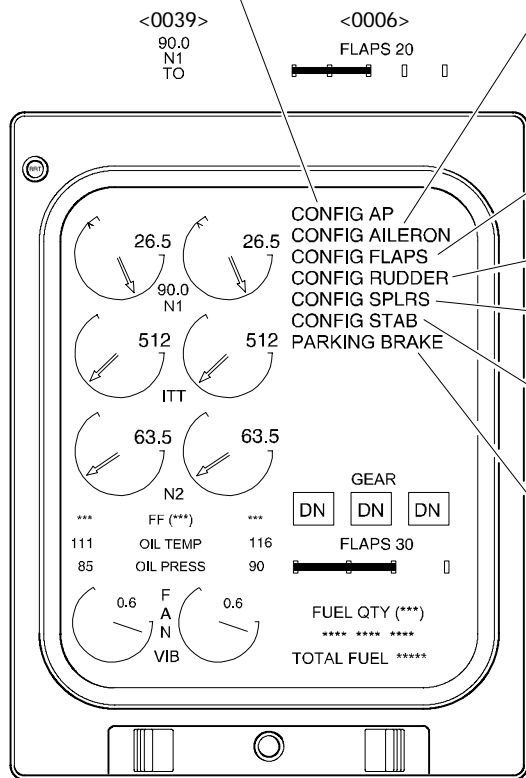

Primary Page

Take-Off Configuration Warnings <MST>
Figure 02-20-9

	AURAL/VISUAL INDICATING AND RECORDING Engine Indication and Crew Alerting System	Vol. 1	02-20-25
		REV 56, Jan 31/03	

O. Landing Configuration Warning

The landing gear warning horn will sound if:

- 2 minutes after ground to air transition with any landing gear not down and locked
and
- The indicated airspeed is less than or equal to 163 knots with one or both thrust levers selected to IDLE
or
- The indicated airspeed is less than or equal to 185 knots with the flaps at less than 5 degrees and one or both thrust levers selected to IDLE.

NOTE

The landing gear horn may be muted with one thrust lever at IDLE and the landing gear not in the down and locked position. Refer to Chapter 16, Landing Gear.

The "Too low gear" aural warning is heard if any landing gear is not down and locked with the radio altitude less than 500 ft AGL and the indicated airspeed at less than 190 knots.

	Flight Crew Operating Manual CSP A-013	MASTER
--	---	---------------



P. MENU Page

The MENU page, in conjunction with the EICAS control panel is used to set the N1 bugs on the Primary page and to zero the fuel used indication on the FUEL synoptic page. The MENU page is divided into two sections: menu section and the confirmation section. The menu section contains two line items N1 REFERENCE and FUEL USED RESET. The confirmation section has ACCEPT and CANCEL lines. The UP/DN buttons on the EICAS control panel (ECP) are used to move a cursor, on the left side of the page, to a desired line. The SEL button, on the ECP, is used to select the line item. If the FMS is not available, the FLIGHT NUMBER line will also be displayed in the menu section.

The MENU page, in conjunction with the EICAS control panel is used to set the N1 bugs on the Primary page and to zero the fuel used indication on the FUEL synoptic page. The MENU page is divided into two sections: menu section and the confirmation section. The menu section contains two line items N1 REFERENCE and FUEL USED RESET. The confirmation section has ACCEPT and CANCEL lines. The UP/DN buttons on the EICAS control panel (ECP) are used to move a cursor, on the left side of the page, to a desired line. The SEL button, on the ECP, is used to select the line item. Normally, the FMS is used to program the FLIGHT NUMBER, but if the FMS is not available, the FLIGHT NUMBER and SET IRS HDG lines will be displayed in the menu section. The SET POS will appear after the IRS heading has been set. <0025>

The MENU page is divided into two sections: menu section and the confirmation section. Normally, no line items are displayed in the menu section, but if the FMS is not available the following items that are normally programmed by the FMS will be displayed: N1 REFERENCE, FUEL USED RESET, and FLIGHT NUMBER. The MENU page, in conjunction with the EICAS control panel is then used to select the listed items. The confirmation section has ACCEPT/CANCEL lines used to accept or cancel the programming inputs. A cursor on the left side of the page is controlled by the UP/DN buttons on the EICAS control panel (ECP). The SELECT button on the ECP is used to select an line item.

The MENU page is divided into two sections: menu section and the confirmation section. Normally, no line items are displayed in the menu section, but if the FMS is not available the following items that are normally programmed by the FMS will be displayed: N1 REFERENCE, FUEL USED RESET, FLIGHT NUMBER and SET IRS HDG. The SET POS will appear after the IRS heading has been set. The MENU page, in conjunction with the EICAS control panel is then used to select the listed items. The confirmation section has ACCEPT/CANCEL lines used to accept or cancel the programming inputs. A cursor on the left side of the page is controlled by the UP/DN buttons on the EICAS control panel (ECP). The SELECT button on the ECP is used to select an line item. <0024><0025><0039><0025><0039><0050>

FLIGHT NUMBER

- Used to input the flight number for display on the status page (only displayed if the FMS is not available).

FUEL USED RESET Line

- Accessed through UP/DN keys on EICAS control panel.
- Cursor will go to ACCEPT line and prompt message will appear.
- SEL switch on EICAS control panel is used to confirm selection.
- CANCEL line used to cancel change (not reset fuel used).
- Fuel synoptics page will display reset value.

PROMPT MESSAGE (white)

TAKE-OFF N₁ SPEED REFERENCE

- Green - Active and / or preset data that may be displayed on primary page if conditions are met.
 - Cyan - Data being edited.
 - White - Inactive or default data.
- Line defaults to last entered value.

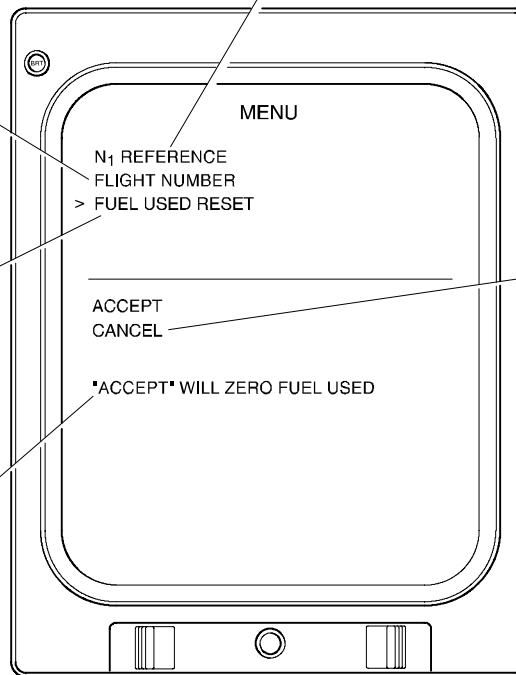

ACCEPT/CANCEL

- Editing lines:
- Used to insert edits into system or cancel the edit.
- Works in conjunction with the SEL button on the EICAS control panel.

Menu Page

Menu Page <0024><0050>
Figure 02-20-10

TAKE-OFF N₁ SPEED REFERENCE

- Green - Active and / or preset data that may be displayed on primary page if conditions are met.
- Cyan - Data being edited.
- White - Inactive or default data.
Line defaults to last entered value.

FLIGHT NUMBER

- Used to input the flight number for display on the status page (only displayed if the FMS is not available).

**SET IRS HDG
SET POS**

- Used to set IRS initial position or heading when FMS control display units are inoperative. SET POS appears after IRS heading has been set (only displayed if FMS is not available).

FUEL USED RESET Line

- Accessed through UP/DN keys on EICAS control panel.
- Cursor will go to ACCEPT line and prompt message will appear.
- SEL switch on EICAS control panel is used to confirm selection.
- CANCEL line used to cancel change (not reset fuel used).
- Fuel synoptics page will display reset value.

ACCEPT/CANCEL

- Editing lines:
- Used to insert edits into system or cancel the edit.
- Works in conjunction with the SEL button on the EICAS control panel.

PROMPT MESSAGE (white)

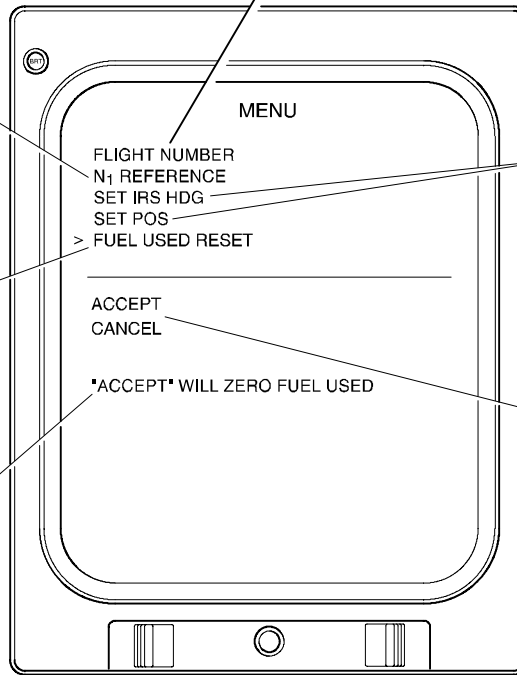

Menu Page

Menu Page <0025>
Figure 02-20-11

TAKE-OFF N₁ SPEED REFERENCE

- Green - Active and / or preset data that may be displayed on primary page if conditions are met.
- Cyan - Data being edited.
- White - Inactive or default data. Line defaults to last entered value.

FLIGHT NUMBER

- Used to input the flight number for display on the status page.

NOTE

The menu items are only displayed if the FMS is not available

FUEL USED RESET Line

- Accessed through UP/DN keys on EICAS control panel.
- Cursor will go to ACCEPT line and prompt message will appear.
- SEL switch on EICAS control panel is used to confirm selection.
- CANCEL line used to cancel change (not reset fuel used).
- Fuel synoptics page will display reset value.

**SET IRS HDG
SET POS**

- Used to set IRS initial position or heading when FMS control display units are inoperative. SET POS appears after IRS heading has been set (only displayed if FMS is not available).

ACCEPT/CANCEL

- Editing lines:
- Used to insert edits into system or cancel the edit.
- Works in conjunction with the SEL button on the EICAS control panel.

PROMPT MESSAGE (white)

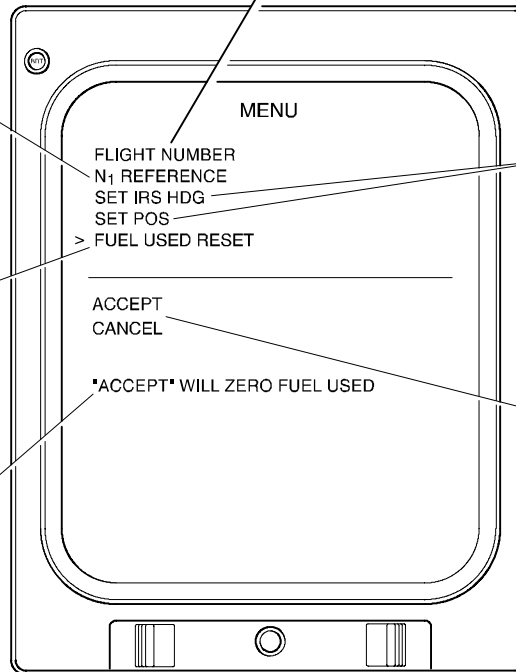

Menu Page

Menu Page <0039>
Figure 02-20-12



Q. System Circuit Breakers

SYSTEM	SUB-SYSTEM	CB NAME	BUS BAR	CB PANEL	CB LOCATION	NOTES
EICAS	Primary Display	PRIM DISPL	DC BUS 1	1	H3	
			BATTERY BUS	2	Q6	
	Secondary Display	SEC DISPL	DC BUS 1	1	H4	
			BATTERY BUS	2	Q7	
	Control Panel	CONT PNL	BATTERY BUS	2	Q8	
	Lamp Driver Unit	EICAS LDU L	DC BUS 1	1	H5	
		EICAS LDU R	BATTERY BUS	2	Q9	
	Bright / Dim Power Supply	BRT/DIM PWR SUP 1, 2, 3	DC BUS 1	1	H6-8	
			BATTERY BUS	2	Q10-12	
	DCU 1	EICAS DCU 1 CH-A,CH-B	DC ESS	4	C10-11	
				2	Q2-3	
	DCU 2	EICAS DCU 2 CH-A,CH-B	BATTERY DIRECT	6	A6	
				2	Q4-5	
	DCU 3	EICAS DCU 3 CH-A,CH-B	BATTERY DIRECT	6	A6	
DC BUS 2				2	K6-7	

	AURAL/VISUAL INDICATING AND RECORDING Recording	Vol. 1	02-30-1
		REV 56, Jan 31/03	

1. RECORDING

A flight data recorder (FDR) records aircraft systems data (including altitude, airspeed, position, heading, acceleration and radio communications events). The FDR provides a digital record of aircraft data for the last 25 hours of aircraft operation. The FDR normally receives data from data concentrator unit No.1 (DCU 1), records the information and sends it back to the DCU1 for comparison. If DCU 1 fails, DCU 2 will supply the data to the FDR.

The FDR will operate when the STROBE lights switch or BEACON lights switch is selected on, or if the aircraft is in a weight off wheels condition. The FDR has an internal clock which is used as the time reference from which events are recorded. An event can be marked by the pilot by operation of a FDR EVENT button on the Miscellaneous Test panel.

A cockpit voice recorder (CVR) starts recording as soon as power is applied to the aircraft. It has a solid state non-volatile memory that records cockpit and mixed PA audio. The unit has a recording capacity of 30 minutes (120 minutes, depending on option). The deceleration of impact removes the power to prevent the data from being erased.

The FDR and CVR each includes an underwater locator device (ULD). The ULD is a battery operated, underwater, pulsed acoustic beacon which has an internal switch that is activated by water. When activated, the unit sends out a 36.5 to 38.5 kilohertz signal.

	Flight Crew Operating Manual CSP A-013	MASTER
--	---	---------------

TEST

Used to test CVR.

- Hold for 5 seconds. Test light illuminates to indicate successful test.

HEADSET

Used to connect headset to monitor recording tone during test.

ERASE

Used to erase previous recording, while on ground.

FDR EVENT

Pushing and holding for a period of 2 seconds records a time stamp on the FDR.

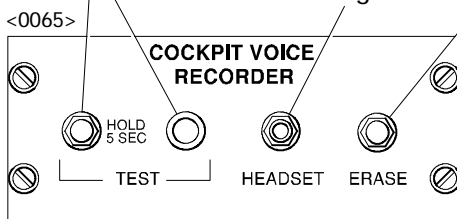

**Cockpit Voice Recorder Panel
Pilot's Instrument panel**

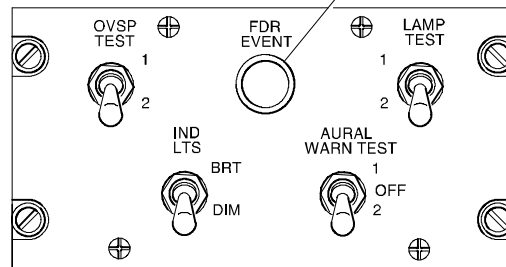

**Miscellaneous Test Panel
Center Pedestal**

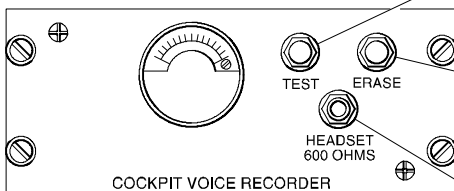

**Cockpit Voice Recorder Panel
Pilot's Instrument panel**

TEST

Used to test CVR.

HEADSET

Used to connect headset to monitor recording tone during test.

ERASE

Used to erase previous recording, while on ground.

Recording <MST>
Figure 02-30-1

FDR EVENT advisory (green)
Indicates that a FDR EVENT was selected.

FDR FAIL status (white)
Indicates a difference between the recorded data and the data supplied by the DCU.

FDR ACCEL FAIL status (white)
Indicates a FDR accelerometer out of tolerance on the ground with the parking brake set and DC bus 1 on (stays latched until FDR event button pressed for 2 seconds).

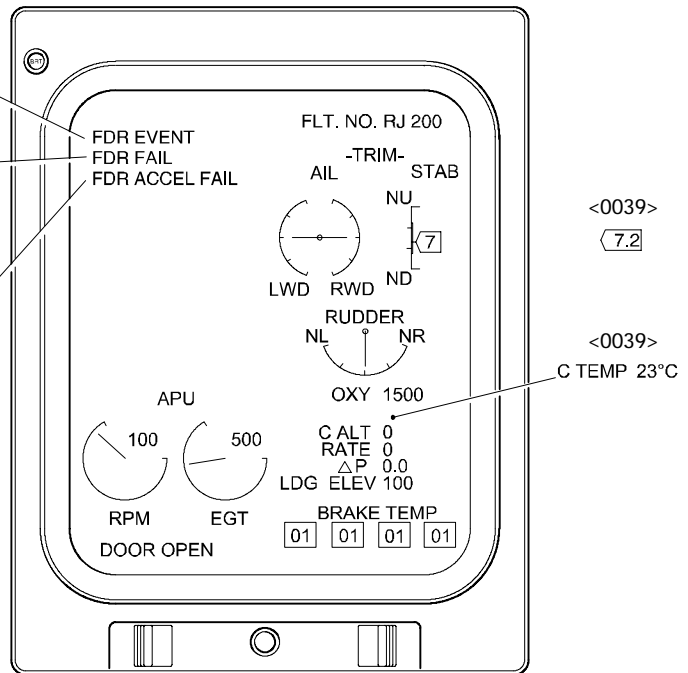

Status Page

Recording – EICAS Indications <MST>
Figure 02-30-2



**AURAL/VISUAL INDICATING AND
RECORDING
Recording**

Vol. 1

02-30-4

REV 56, Jan 31/03

A. System Circuit Breakers

SYSTEM	SUB-SYSTEM	CB NAME	BUS BAR	CB PANEL	CB LOCATION	NOTES
Recording	Flight Data Recorder	FLIGHT REC PWR	AC BUS 1	1	C9	
		FLIGHT REC CONT	DC BUS 1		K2	
	Cockpit Voice Recorder	CKPT VOICE REC	DC ESSENTIAL	4	D7	

	AURAL/VISUAL INDICATING AND RECORDING Maintenance Data Computer	Vol. 1	02-40-1
		REV 56, Jan 31/03	

1. MAINTENANCE DIAGNOSTIC SYSTEM

The maintenance diagnostic system is used by maintenance personnel to view current and historical information relating to specific aircraft systems health and operation.

The system uses a maintenance diagnostic computer (MDC) to process and record avionics and aircraft systems data for future retrieval. A maintenance switch, located behind the pilot's seat, is used to enter the maintenance diagnostics mode. The multifunctional displays (MFD's) are used to display the maintenance data and the EICAS control panel is used to control and select information on the MFD display. Status and function information for all aircraft Line Replaceable Units (LRU's) is displayed in coded words using different numbering systems (binary, octal and hexadecimal). Maintenance personnel use a data dictionary to decode the displayed information.

A data loader unit is used to upload or download data to or from a floppy disk.

When the maintenance switch is set to MFD1 or MFD2, the applicable MFD is configured to display maintenance related display pages and the respective Display Control Panel (DCP) is configured as a maintenance page control panel. The first page displayed will be the MAINTENANCE MENU page.

	Flight Crew Operating Manual CSP A-013	MASTER
--	---	---------------

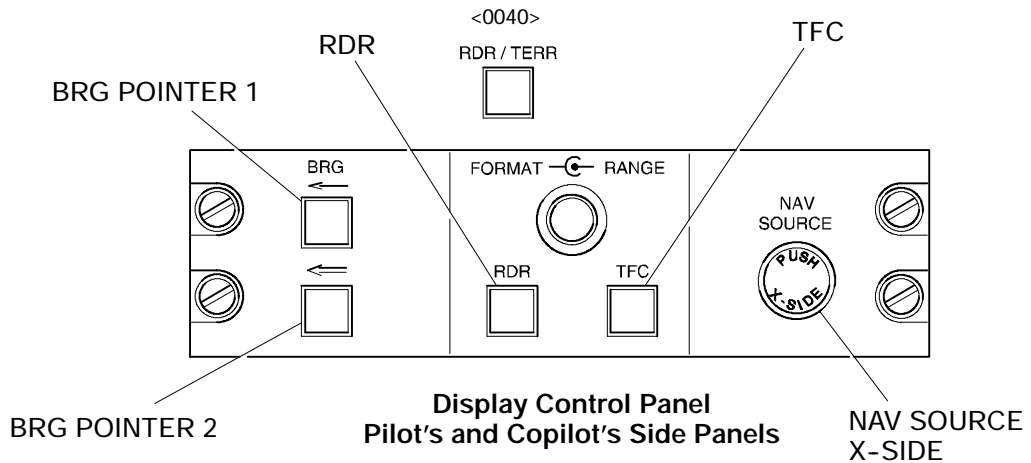
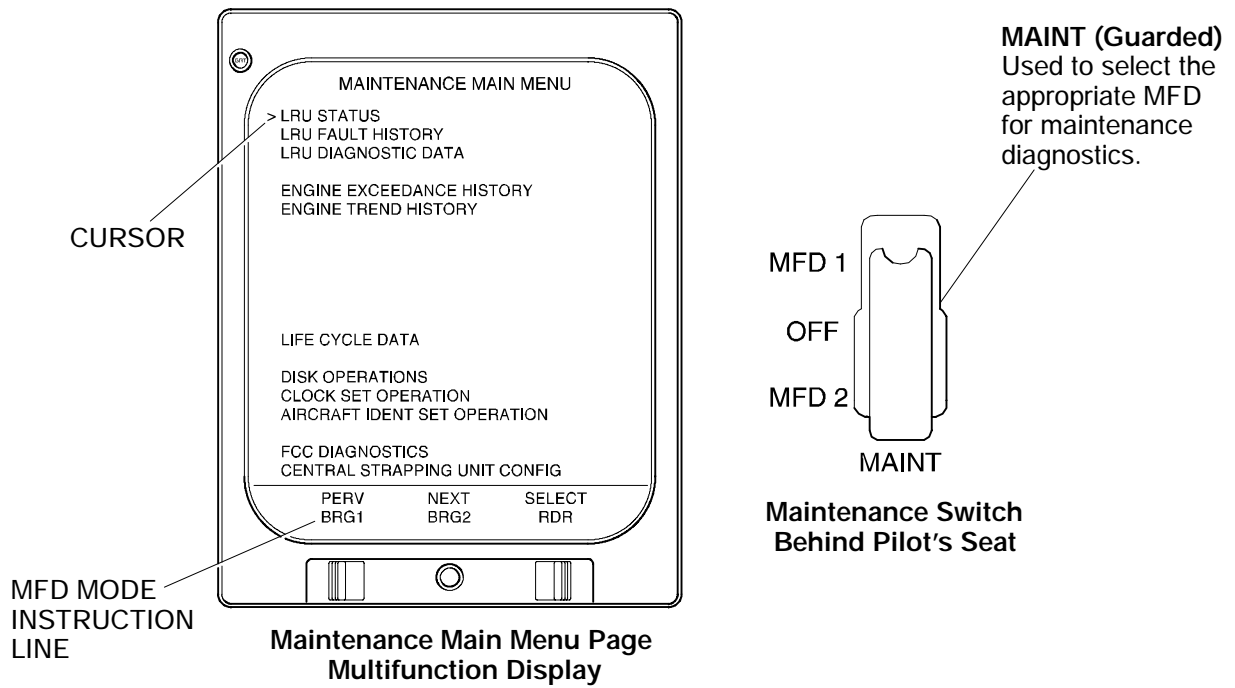

Maintenance Diagnostic Computer System <MST>
Figure 02-40-1

	AURAL/VISUAL INDICATING AND RECORDING Maintenance Data Computer	Vol. 1	02-40-3
		REV 56, Jan 31/03	

A. Maintenance Menu Page Overview

- LRU STATUS - Displays a list of current (MDC detected) non-functioning LRU's and their status.
- LRU FAULT HISTORY - Displays a list of all stored LRU faults, in the MDC memory, for the last 50 flight legs.
- LRU DIAGNOSTIC DATA- Displays a list of all LRU's and the current bit patterns of the diagnostic words of each LRU.
- ENGINE EXCEEDANCE HISTORY- Displays a list of all engine exceedances for the past 50 flight legs.
- ENGINE TREND HISTORY - During each flight leg the MDC stores in its memory a list of selected engine parameters (called a snapshot) The MDC can store up to 50 snapshots.
- LIFE CYCLE DATA- Displays the number of thrust reverser cycles and the engine operating hours.
- DISK OPERATIONS - In conjunction with the data loader, is used to upload or download MDC files.
- CLOCK SET OPERATION - Used to set the MDC internal clock. Normally, the MDC uses the aircraft clocks for time reference. If the aircraft clocks fail, the MDC internal clock is used.
- AIRCRAFT IDENT SET OPERATION- Used to set aircraft identification for the LRU's.
- FCC DIAGNOSTICS - Displays instructions to put flight control system into diagnostic mode.
- CENTRAL STRAPPING UNIT CONFIG-Used to check the configuration of the integrated avionics processor system (IAPS) computers.

When in the MDC mode, the Display Control Panel buttons function as follows:

- BRG1 (upper) - used to move the cursor UP, or to scroll backward.
- BRG2 (lower) - used to move the cursor DOWN, or to scroll forward.
- RDR - used to select a line, or to switch the display format from binary to hexadecimal.
- TFC - used to return to the menu page.
- NAV SOURCE - used to display computer word labels.

	Flight Crew Operating Manual CSP A-013	MASTER
--	---	---------------

B. Data Loader Unit

The data loader is a portable unit that plugs into a connector on the copilots bulkhead below circuit breaker panel No. 2. Through the download function from the MENU page, the unit enables the transfer of data files, between DOS-compatible diskettes and applicable aircraft systems. The data loader unit provides the capability to format disks, read directories and read/write files.

The data loader is mounted between the galley and the aft side of the copilots bulkhead. Through the download function from the MENU page, the unit enables the transfer of data files, between DOS-compatible diskettes and applicable aircraft systems. The data loader unit provides the capability to format disks, read directories and read/write files. <0018>

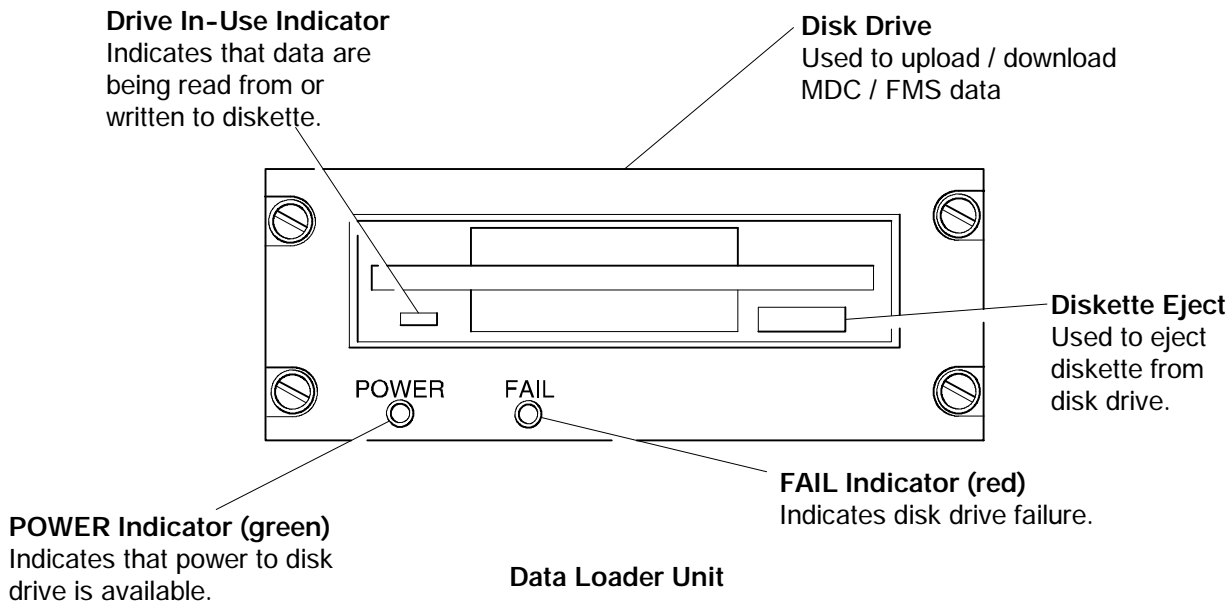

NOTE

Indicators are not dimmable.

Data Loader Unit <0018>
Figure 02-40-2

C. System Circuit Breakers

SYSTEM	SUB-SYSTEM	CB NAME	BUS BAR	CB PANEL	CB LOCATION	NOTES
Maintenance Data Computer	MDC	IAPS LEFT MDC	DC BUS 1	1	H2	
		IAPS LEFT FMS/ MDC <0024><0050>				



**AURAL/VISUAL INDICATING AND
RECORDING
Maintenance Data Computer**

Vol. 1

02-40-6

REV 56, Jan 31/03

THIS PAGE INTENTIONALLY LEFT BLANK

**Flight Crew Operating Manual
CSP A-013**

MASTER