

## CHAPTER 9 – EMERGENCY EQUIPMENT

	Page
<b>TABLE OF CONTENTS</b>	<b>09-00</b>
Table of Contents	09-00-1
<b>INTRODUCTION</b>	<b>09-10</b>
Introduction	09-10-1
<b>OXYGEN</b>	<b>09-20</b>
Oxygen	09-20-1
Crew Oxygen System	09-20-1
Crew Oxygen Bottle	09-20-4
Pressure Sensor/Regulator Unit	09-20-4
Crew Oxygen Mask	09-20-4
Ground Servicing Panel	09-20-9
Minimum Flight Crew Oxygen Pressure	09-20-9
Crew Oxygen Consumption Data (As per FAR 121.333)	09-20-9
Passenger Oxygen System	09-20-11
Portable Oxygen System	09-20-15
System Circuit Breakers	09-20-17
<b>EVACUATION DEVICES</b>	<b>09-30</b>
Evacuation Devices	09-30-1
Emergency Locator Transmitter	09-30-1
<b>FIRE FIGHTING EQUIPMENT</b>	<b>09-40</b>
Fire Fighting Equipment	09-40-1
Portable Halon Fire Extinguishers	09-40-1
Portable Water Fire Extinguishers <0067>	09-40-3
Fire Protection Gloves	09-40-5
Protective Breathing Equipment	09-40-5
<b>OVER WATER EMERGENCY EQUIPMENT</b>	<b>09-50</b>
Over Water Emergency Equipment	09-50-1

### LIST OF ILLUSTRATIONS

<b>INTRODUCTION</b>		
Figure 09-10-1	Placards	09-10-2
<b>OXYGEN</b>		
Figure 09-20-1	Crew Oxygen System - Schematic	09-20-2
Figure 09-20-2	Crew Oxygen System	09-20-3
Figure 09-20-3	Crew Oxygen Mask	09-20-6
Figure 09-20-4	Smoke Goggles/Full Face Mask	09-20-7



**EMERGENCY EQUIPMENT  
Table of Contents**

Vol. 1

09-00-2

REV 56, Jan 31/03

Figure 09-20-5	Crew Oxygen System - EICAS Indications	09-20-8
Figure 09-20-6	Passenger Oxygen System	09-20-13
Figure 09-20-7	Passenger Oxygen - Control and EICAS Indication	09-20-14
Figure 09-20-8	Portable Oxygen System	09-20-16

**EVACUATION DEVICES**

Figure 09-30-1	Emergency Locator Transmitter	09-30-2
----------------	-------------------------------	---------

**FIRE FIGHTING EQUIPMENT**

Figure 09-40-1	Portable Halon Fire Extinguisher	09-40-2
Figure 09-40-2	Portable Water Fire Extinguisher <0067>	09-40-4
Figure 09-40-3	Protective Breathing Equipment <0061>	09-40-6
Figure 09-40-4	Protective Breathing Equipment <0062>	09-40-7
Figure 09-40-5	Protective Breathing Equipment <0063>	09-40-8
Figure 09-40-6	Protective Breathing Equipment <0064>	09-40-9

**OVER WATER EMERGENCY EQUIPMENT**

Figure 09-50-1	Life Vest	09-50-2
Figure 09-50-2	Life Vest Operation	09-50-3

	<b>Flight Crew Operating Manual CSP A-013</b>	<b>MASTER</b>
--	---	---------------

	<b>EMERGENCY EQUIPMENT Introduction</b>	Vol. 1	09-10-1
		REV 56, Jan 31/03	

## 1. INTRODUCTION

This chapter describes the systems and equipment which are essential to the safety of the passengers and crew during a fire, rapid decompression, ditching and emergency evacuation. The emergency equipment consists of the following:

- Oxygen equipment (portable and fixed)
- Evacuation devices (crash axe, escape rope and escape path markings)
- Emergency locator transmitter (ELT)
- Fire fighting equipment (portable and fixed)
- Over water emergency equipment (life vests)
- First aid equipment.

Placards containing symbols are used to indicate the location of the emergency equipment. Data on the emergency exits is contained in Chapter 6. Data on emergency lighting is contained in Chapter 17.

	<b>Flight Crew Operating Manual CSP A-013</b>	<b>MASTER</b>
--	---	---------------



HALON FIRE  
EXTINGUISHER



MEGAPHONE

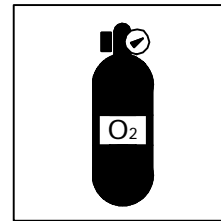

OXYGEN CYLINDER

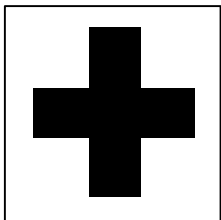

FIRST AID KIT



LIFE VEST

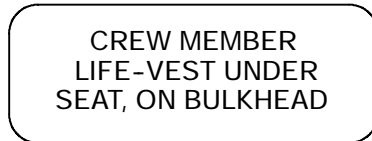

CREW MEMBER  
LIFE-VEST UNDER  
SEAT, ON BULKHEAD

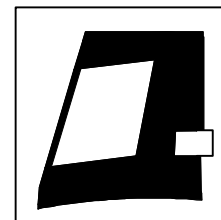

SMOKE HOOD  
(PROTECTIVE BREATHING  
EQUIPMENT)



DOOR 1 L

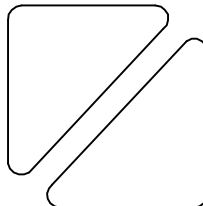

CREW MEMBER PBE

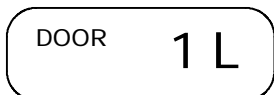

DOOR 1 L



FIRE GLOVES  
INSIDE



FIRE EXTINGUISHER  
INSIDE



CREW MEMBER PBE  
INSIDE

Placards  
Figure 09-10-1

	<b>EMERGENCY EQUIPMENT Oxygen</b>	Vol. 1	09-20-1
		REV 56, Jan 31/03	

## 1. OXYGEN

The aircraft oxygen systems consists of two independent systems that supply oxygen to the flight crew and passengers in an emergency such as depressurization, decompression, smoke, fumes, first aid or during certain aircraft operations. One system supplies stored oxygen to the flight compartment crew and the other system supplies generated oxygen to the passengers and flight attendants.

The aircraft oxygen systems consists of one independent system that supplies stored oxygen to the flight compartment crew in an emergency such as depressurization, decompression, smoke, fumes, first aid or during certain aircraft operations. <0056>

In addition, portable oxygen bottles are provided in specific areas in the passenger compartment.

### A. Crew Oxygen System

The crew oxygen system consists of:

- Oxygen bottle
- Pressure sensor/regulator unit
- Three oxygen masks
- Ground servicing panel

	<b>Flight Crew Operating Manual CSP A-013</b>	<b>MASTER</b>
--	---	---------------

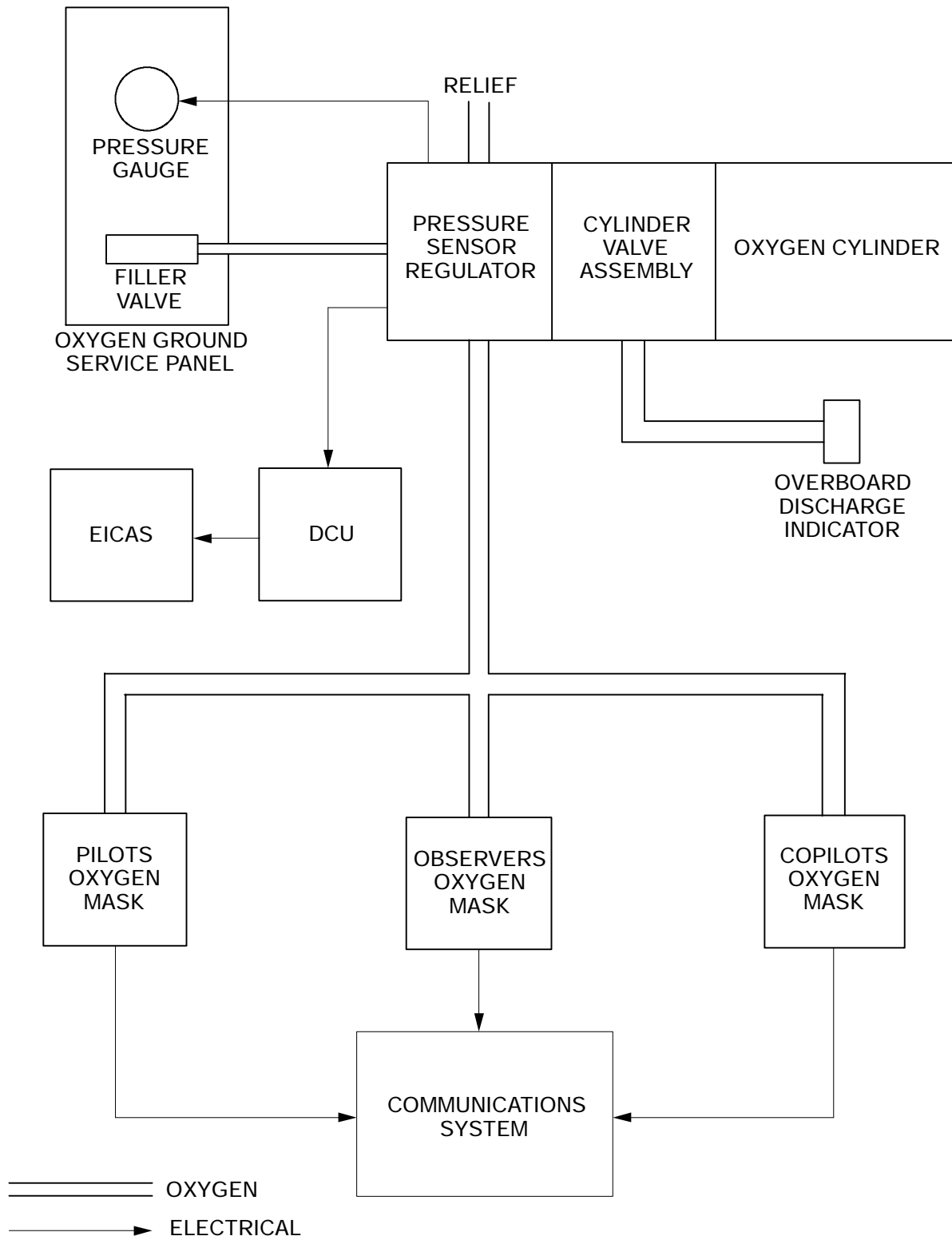

Crew Oxygen System – Schematic  
Figure 09-20-1

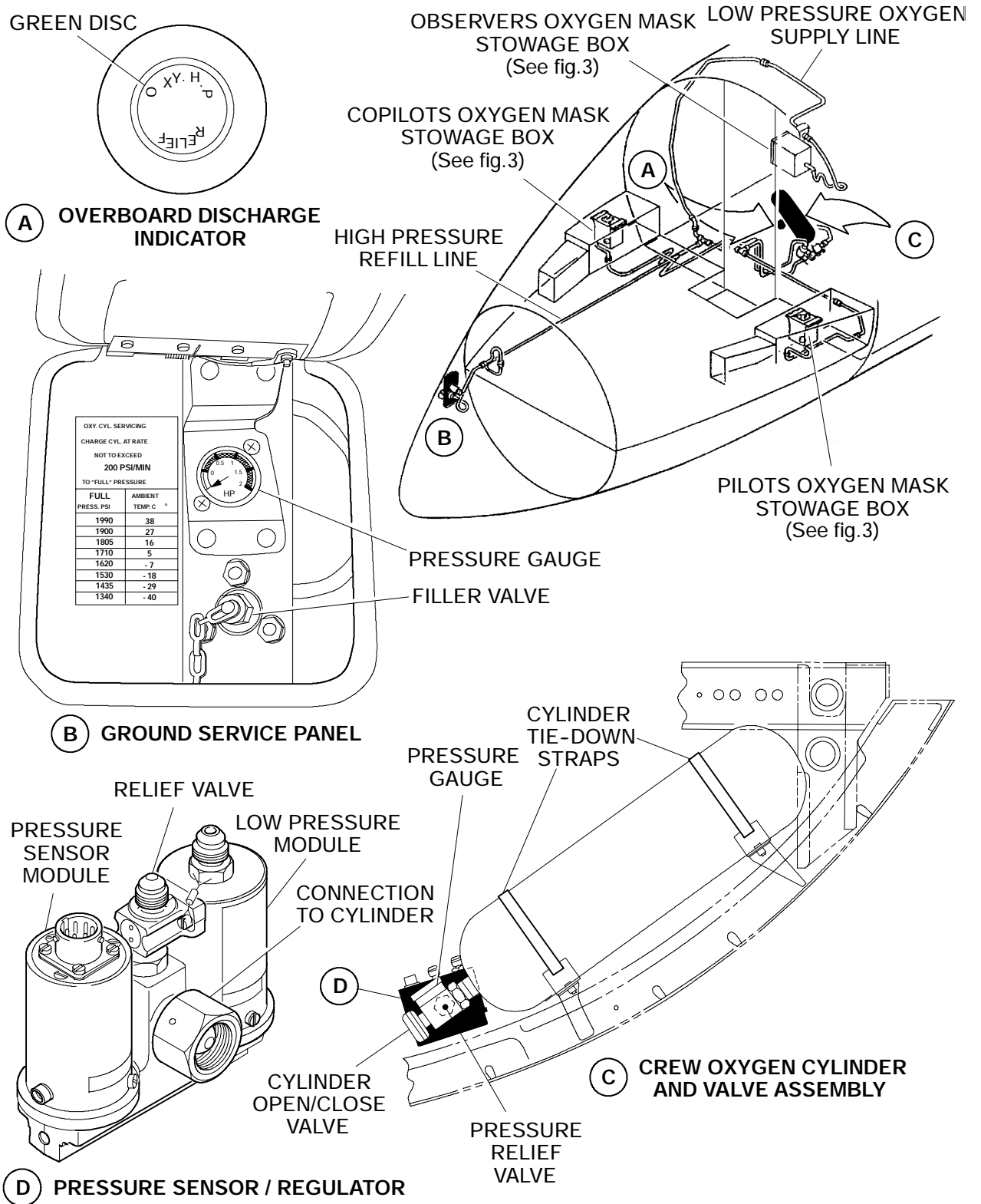

Crew Oxygen System  
Figure 09-20-2



**EMERGENCY EQUIPMENT  
Oxygen**

Vol. 1

09-20-4

REV 56, Jan 31/03

**B. Crew Oxygen Bottle**

The crew oxygen bottle is a high pressure Kevlar cylinder and is located in the forward fuselage underfloor area. The bottle assembly consists of a manual shut-off valve, pressure gauge, and a pressure relief valve. The bottle contains 50.0 cubic feet (1.415 cubic meters) of oxygen pressured to 1850 psi at 70°F (12.76 MPa at 21°C). If the internal bottle pressure exceeds 2800 psi (193 bars), the pressure relief valve opens and the bottle pressure is vented overboard through a high pressure discharge line. When the contents of the oxygen bottle is vented overboard, a green snap frangible disc (located on the right forward fuselage) blows out, presenting a visual indication that the oxygen bottle contents have been vented.

**C. Pressure Sensor/Regulator Unit**

The pressure sensor/regulator unit controls the flow of oxygen from the bottle to the masks. The unit is connected to the oxygen cylinder, crew masks and the ground servicing panel and consists of a pressure sensor, pressure regulator and pressure relief valve.

The pressure regulator receives oxygen pressure from the bottle at 1850 psi (12.76 MPa) and decreases the outlet pressure flow to the crew masks to 78 psi (538 kPa).

The pressure sensor monitors the supply pressure from the cylinder and supplies pressure indications to the servicing panel and EICAS. If the supply pressure from the bottle decreases below 1410 psig (9.721 MPa), the sensor will send a signal to the EICAS to display an OXY LO PRESS caution message on the primary page.

If the regulator outlet pressure exceeds 109 psi (752 kPa), the relief valve opens to vent the excess pressure. The valve will reset when the pressure decreases.

**D. Crew Oxygen Mask**

The crew oxygen masks are located in stowage boxes. One for the pilot, one for the copilot and one for the 3rd flight crew position. The crew mask includes an oxygen regulator, a pneumatically controlled inflatable harness, a flow-control knob, a mixture-control lever and a microphone. To release the mask from the stowage box, the operator squeezes the red release levers and holds them. This action opens the quick-release doors, frees the mask and inflates the harness. The operator then dons the mask. The red levers are then released, which deflates the harness, causing the mask to install correctly on the operator's head. The smoke goggles are separate from the mask and are stowed in a pouch in the bottom of each stowage box. The smoke goggles can be donned over the mask and eye glasses and are used by crew members when smoke or toxic fumes are present in the cockpit. With the mask in the positive pressure mode, the user activates the purge valve, located on the top of the mask face piece to pressurize the goggles. This prevents smoke or fumes from entering the goggles and irritating the eyes.

	<b>Flight Crew Operating Manual CSP A-013</b>	<b>MASTER</b>
--	---	---------------





**EMERGENCY EQUIPMENT  
Oxygen**

**Vol. 1**

09-20-5

REV 56, Jan 31/03

The crew oxygen masks are located in stowage boxes. One for the pilot, one for the copilot and one for the 3rd flight crew position. The crew mask is a full face mask and includes an oxygen regulator, a pneumatically controlled inflatable harness, a flow-control knob, a mixture-control lever and a microphone. To release the mask from the stowage box, the operator squeezes the red release levers and holds them. This action opens the quick-release doors, frees the mask and inflates the harness. The operator then dons the mask. The red levers are then released, which deflates the harness, causing the mask to install correctly on the operator's head. <0033>

Oxygen is supplied to the mask regulator at 78 psig (538 kPa). The regulator control (N/100% positions) allows the user to select a mixture of oxygen and ambient air or pure oxygen.

When the regulator control is set to the N position, a mixture of ambient air and pressurized oxygen is supplied to the mask on demand.

With the control set to the 100% position, pure oxygen is supplied to the mask on demand.

The flow control knob is used to adjust the oxygen flow. If the knob is turned clockwise to the EMERGENCY position, the mask is supplied a constant flow of 100% oxygen at a positive pressure. To test the oxygen flow, press the flow control knob, which momentarily supplies oxygen to the mask.

When cabin altitude is more than 30,000 feet (9,144 meters), the mask supplies pure oxygen regardless of the N/100% switch position.

To remove the mask, the red release levers on the mask are squeezed, which inflates the harness to allow the mask to be removed from the operators head.

**Blinker**

Shows yellow cross when oxygen is flowing or when harness is inflated. Black, indicates no oxygen flow.

**Test/Reset Lever (spring-loaded to RESET)**

Press to test oxygen flow (momentarily) through the regulator (microphone test without pulling the mask out).

**Normal/100% Lever**

- N - Provides a mixture of ambient air with oxygen on demand.
- 100% - Provides 100% oxygen on demand.

**Oxygen On Flag (white)**

In view when mask is out, indicates that oxygen shut-off valve is open. Flag will disappear when shut-off valve is closed. Reset position shuts off supply to mask regulator and blinker unit.

**Release Levers (red)**

Squeeze to unlock container doors, grasp levers and hose and pull to withdraw mask.

**Emergency Flow Control**

- Rotate in direction of arrow to supply a continuous 100% oxygen flow.
- Rotate to adjust the supply pressure.
- Press to check whether a continuous flow will be available.

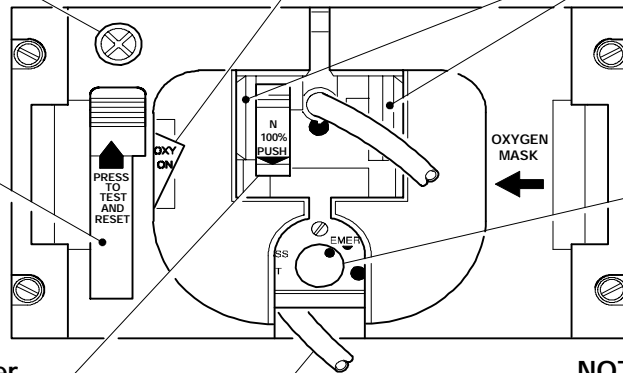

**Oxygen Supply Hose**

**NOTE**

Operating the TEST / RESET LEVER to RESET will stop the flow of oxygen to the masks. Closing the doors on the mask storage compartments will also stop the flow of oxygen to the masks.

Crew Oxygen Mask  
Figure 09-20-3

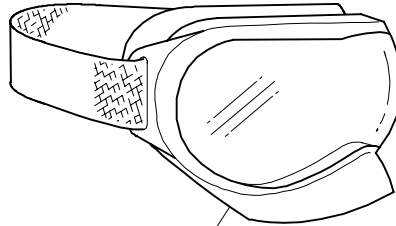
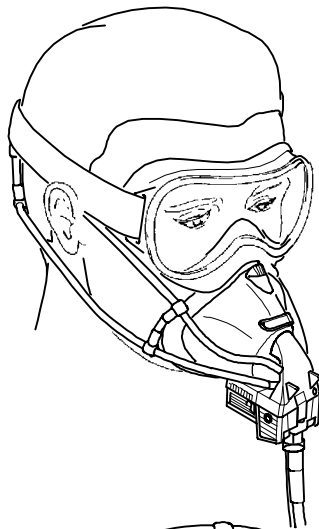

**Smoke Goggles**  
Mates to mask cavity to receive continuous venting and can be worn over standard glasses.

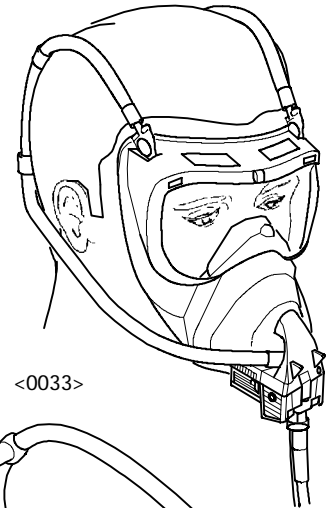

<0033>

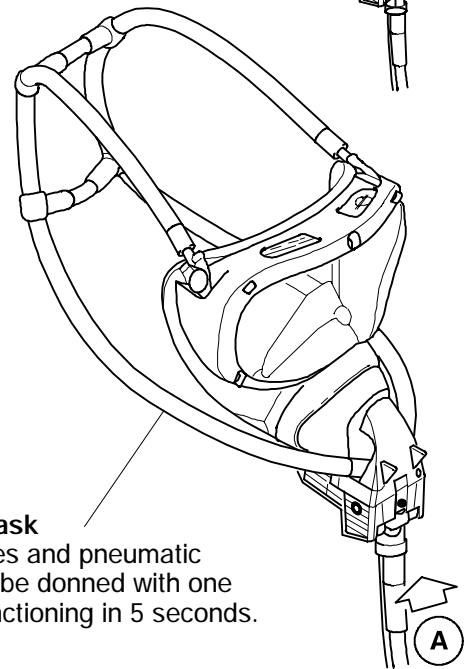

**Pneumatic Harness**

**Full Face Mask**  
Mask, goggles and pneumatic harness can be donned with one hand and functioning in 5 seconds.

**N/100 % Regulator Control**

- N - Provides a mixture of ambient air with oxygen.
- 100% - Provides 100% oxygen.

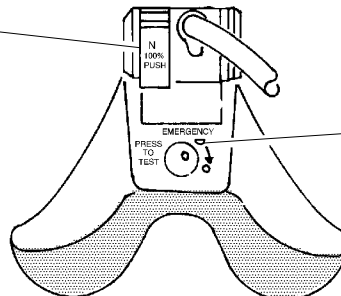

**Flow Control Knob**  
Used to adjust supply pressure.

**A**

Smoke Goggles/Full Face Mask <MST>  
Figure 09-20-4

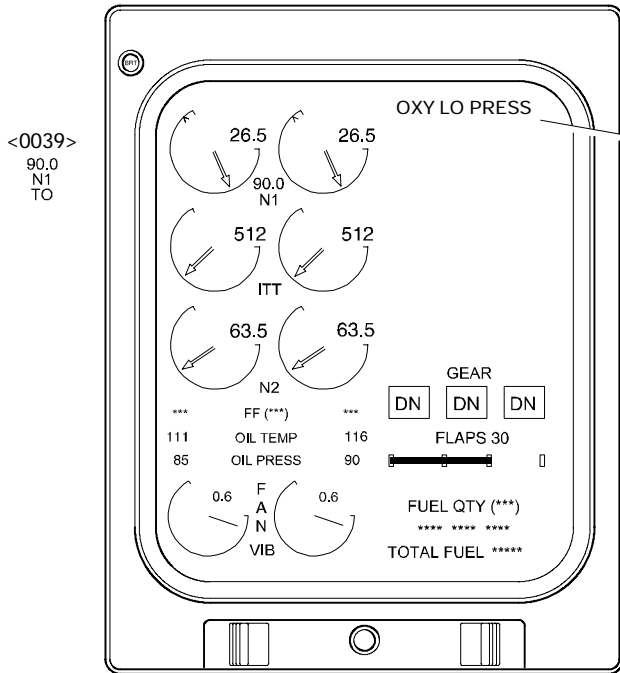

**OXY LO PRESS  
Caution (amber)**  
Comes on to indicate that crew oxygen bottle has less than 1410 psi.

Check dispatch requirements.

**Primary Page**

**Crew Oxygen System Pressure Readout**  
Indicates oxygen system pressure in increments of 10 psi.  
Colors are:  
Amber - < 1410 psi.  
Green - ≥ 1410 psi.

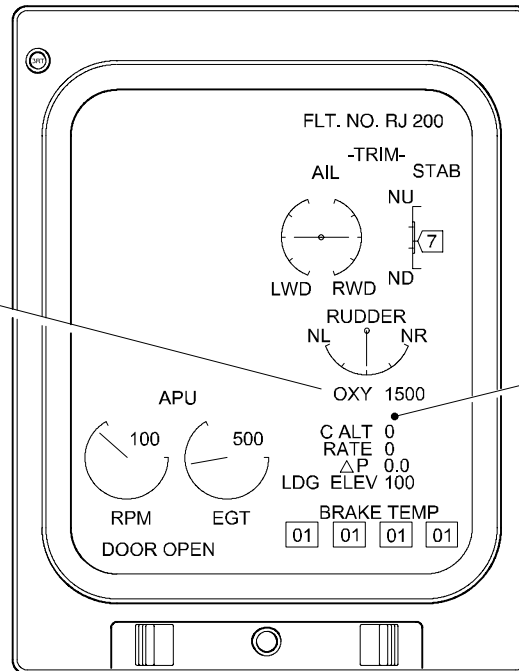

<0039>  
7.2

<0039>  
C TEMP 23°C

**Status Page**

**Crew Oxygen System – EICAS Indications <MST>  
Figure 09-20-5**

**E. Ground Servicing Panel**

The oxygen ground servicing panel is located on the right side of the forward fuselage. The service panel contains a fill port, a pressure servicing chart and a pressure gauge.

**F. Minimum Flight Crew Oxygen Pressure**

Table 1 defines the minimum oxygen system pressure required before departure which corresponds to the quantity of oxygen necessary to perform an emergency decent from 41,000 feet to 10,000 feet in 10 minutes, followed by 110 minutes of cruise at 10,000 feet, with normal (N) mask setting (FAR 121.333).

TABLE 1												
OAT		°C	-40	-30	-20	-10	0	10	20	30	40	50
		°F	-40	-22	-4	14	32	50	68	86	104	122
Min. Press (psi)	2 Crew		889	938	987	1035	1084	1133	1182	1230	1279	1328
	2 Crew + Obs		1208	1282	1357	1431	1505	1579	1654	1728	1802	1877

Table 2 defines the minimum oxygen system pressure required before departure which corresponds to the quantity of oxygen necessary to perform an unpressurized continuous cruise at 10,000 feet for 15 minutes with normal (N) mask setting (JAR OPS 1.780).

TABLE 2												
OAT		°C	-40	-30	-20	-10	0	10	20	30	40	50
		°F	-40	-22	-4	14	32	50	68	86	104	122
Min. Press (psi)	2 Crew		326	330	334	337	341	345	349	352	356	360
	2 Crew + 1 OBS		372	379	387	394	402	409	417	424	432	439

**NOTE**

If the oxygen pressure is between the values listed in table 1 and 2, then there is sufficient oxygen to 10,000 feet for 15 minutes in an unpressurized cabin. If the oxygen pressure is lower than the values given in table 2, then the oxygen bottle must be filled.

**G. Crew Oxygen Consumption Data (As per FAR 121.333)**

The following tables show the total time (in hours and minutes) that oxygen will be available at various mask settings, during various flight conditions, at initial bottle pressures of 1410 psi (pressure threshold that triggers OXY LOW PRESS message on the EICAS) and 1850 psi (max. crew oxygen bottle pressure). A margin of safety of 10% was subtracted from the full charge of 1850 psi in all cases.



**EMERGENCY EQUIPMENT  
Oxygen**

Vol. 1      09-20-10

REV 56, Jan 31/03

<b>LEVEL FLIGHT AT CABIN PRESSURE ALTITUDE OF 8,000 FEET</b>				
<b>Crew members</b>	<b>2</b>		<b>3</b>	
<b>Initial Bottle Pressure</b>	<b>1400 psi</b>	<b>1850 psi</b>	<b>1400 psi</b>	<b>1850 psi</b>
<b>Normal Mask Setting</b>	2 <sup>h</sup> 27'	3 <sup>h</sup> 21'	1 <sup>h</sup> 37'	2 <sup>h</sup> 12'
<b>100% Mask Setting</b>	0 <sup>h</sup> 33'	0 <sup>h</sup> 45'	0 <sup>h</sup> 21'	0 <sup>h</sup> 30'
<b>Emergency Mask Setting</b>	0 <sup>h</sup> 30'	0 <sup>h</sup> 42'	0 <sup>h</sup> 20'	0 <sup>h</sup> 27'

<b>DESCENT (10 Min.) FROM 41,000 feet TO LEVEL FLIGHT AT SAFE ALTITUDE (NORMAL MASK SETTING FOR BOTH DESCENT AND LEVEL FLIGHT)</b>				
<b>Crew members</b>	<b>2</b>		<b>3</b>	
<b>Initial Bottle Pressure</b>	<b>1400 psi</b>	<b>1850 psi</b>	<b>1400 psi</b>	<b>1850 psi</b>
<b>Cabin Pressure Altitude</b>	<b>10,000 Feet</b>	2 <sup>h</sup> 46'	3 <sup>h</sup> 52'	1 <sup>h</sup> 44'
	<b>14,000 Feet</b>	2 <sup>h</sup> 39'	3 <sup>h</sup> 42'	1 <sup>h</sup> 41'
	<b>18,000 Feet</b>	2 <sup>h</sup> 17'	3 <sup>h</sup> 10'	1 <sup>h</sup> 27'
	<b>21,000 Feet</b>	1 <sup>h</sup> 53'	2 <sup>h</sup> 37'	1 <sup>h</sup> 12'

<b>DESCENT (10 Min.) FROM 41,000 feet TO LEVEL FLIGHT AT SAFE ALTITUDE (100% MASK SETTING FOR DESCENT AND NORMAL MASK SETTING FOR LEVEL FLIGHT)</b>				
<b>Crew members</b>	<b>2</b>		<b>3</b>	
<b>Initial Bottle Pressure</b>	<b>1400 psi</b>	<b>1850 psi</b>	<b>1400 psi</b>	<b>1850 psi</b>
<b>Cabin Pressure Altitude</b>	<b>10,000 Feet</b>	2 <sup>h</sup> 35'	3 <sup>h</sup> 41'	1 <sup>h</sup> 33'
	<b>14,000 Feet</b>	2 <sup>h</sup> 33'	3 <sup>h</sup> 36'	1 <sup>h</sup> 34'
	<b>18,000 Feet</b>	2 <sup>h</sup> 14'	3 <sup>h</sup> 07'	1 <sup>h</sup> 24'
	<b>21,000 Feet</b>	1 <sup>h</sup> 52'	2 <sup>h</sup> 36'	1 <sup>h</sup> 11'

<b>DESCENT (10 Min.) FROM 41,000 feet TO LEVEL FLIGHT AT SAFE ALTITUDE (100% MASK SETTING FOR BOTH DESCENT AND LEVEL FLIGHT)</b>				
<b>Crew members</b>	<b>2</b>		<b>3</b>	
<b>Initial Bottle Pressure</b>	<b>1400 psi</b>	<b>1850 psi</b>	<b>1400 psi</b>	<b>1850 psi</b>
<b>Cabin Pressure Altitude</b>	<b>10,000 Feet</b>	0 <sup>h</sup> 31'	0 <sup>h</sup> 45'	0 <sup>h</sup> 19'
	<b>14,000 Feet</b>	0 <sup>h</sup> 38'	0 <sup>h</sup> 54'	0 <sup>h</sup> 24'
	<b>18,000 Feet</b>	0 <sup>h</sup> 48'	1 <sup>h</sup> 07'	0 <sup>h</sup> 30'
	<b>21,000 Feet</b>	0 <sup>h</sup> 57'	1 <sup>h</sup> 19'	0 <sup>h</sup> 36'

	<b>Flight Crew Operating Manual CSP A-013</b>	<b>MASTER</b>
--	---	---------------

	<b>EMERGENCY EQUIPMENT Oxygen</b>	Vol. 1	09-20-11
		REV 56, Jan 31/03	

## H. Passenger Oxygen System

### NOTE

The passenger oxygen system is not applicable to the Special Edition and CUA aircraft.

The passenger oxygen system provides chemically generated oxygen for all cabin occupants in the event of cabin depressurization.

The oxygen generators and oxygen masks are installed as part of the passenger service unit panel and are available at all passenger seats, in the lavatory and at the flight attendant station.

All oxygen compartment doors will open to present the oxygen masks automatically if the cabin altitude reaches approximately 14,000 feet.

If the automatic system fails to open the doors, or if it is necessary to override the automatic system, the flight crew can operate the (guarded) PASS OXY switchlight on the overhead panel to open the oxygen doors in the passenger service units. As a back-up to electrically opening the doors, each individual oxygen compartment door can be opened manually through a release hole in the door.

When the oxygen compartment doors are open, the passengers will pull the oxygen mask to their face, which pulls a lanyard connected to the firing pin of the chemical oxygen generator. This initiates the flow of oxygen to the passenger's oxygen mask. A flow indicator in the supply tube will show green when oxygen is flowing. The reservoir bags on the passenger oxygen masks begins to fill with oxygen. The chemical oxygen generator supplies approximately 13 minutes of oxygen to each mask.

When the oxygen compartment doors are open, the passengers will pull the oxygen mask to their face, which pulls a lanyard connected to the firing pin of the chemical oxygen generator. This initiates the flow of oxygen to the passenger's oxygen mask. A flow indicator in the supply tube will show green when oxygen is flowing. The reservoir bags on the passenger oxygen masks begins to fill with oxygen. The chemical oxygen generator supplies approximately 22 minutes of oxygen to each mask. <0071>

### WARNING

When activated, the oxygen generator surface temperature may reach 260 °C (500 °F). Do not touch or attempt to remove generator. Burn injury can result. If an active generator is inadvertently removed from the compartment, the generator must be placed in a metal container such as a lavatory or galley sink. The generator's heat will scorch other materials or fabrics.

	<b>Flight Crew Operating Manual CSP A-013</b>	<b>MASTER</b>
--	---	---------------



**EMERGENCY EQUIPMENT  
Oxygen**

**Vol. 1**

**09-20-12**

**REV 56, Jan 31/03**

**NOTE**

Odor similar to scorched cloth may be created by activation of a generator. The odor does not affect the purity of the oxygen supply and there is no fire hazard.



**TO OPEN OXYGEN  
COMPARTMENT MANUALLY**

Insert latch release tool  
in latch release slot to  
release latch.

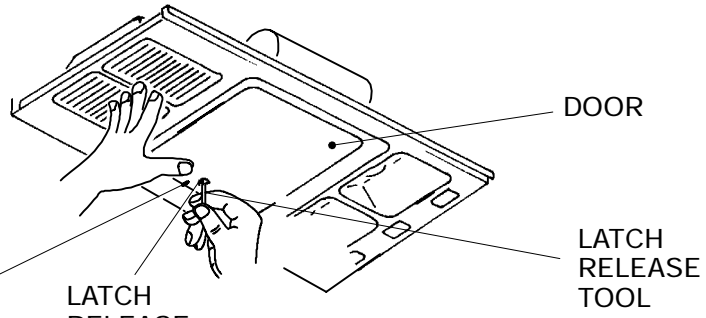

MAINTENANCE TAB (RED)  
INDICATES DOOR DISABLED

LANYARD  
(APPROX. 5 INCH)

MASKS

**NOTE**

Oxygen compartment door  
latches electrically. Opened  
by CPAM (Cabin alt at 14000 FT.)  
or pilot operation of PASS OXY  
switch/light.

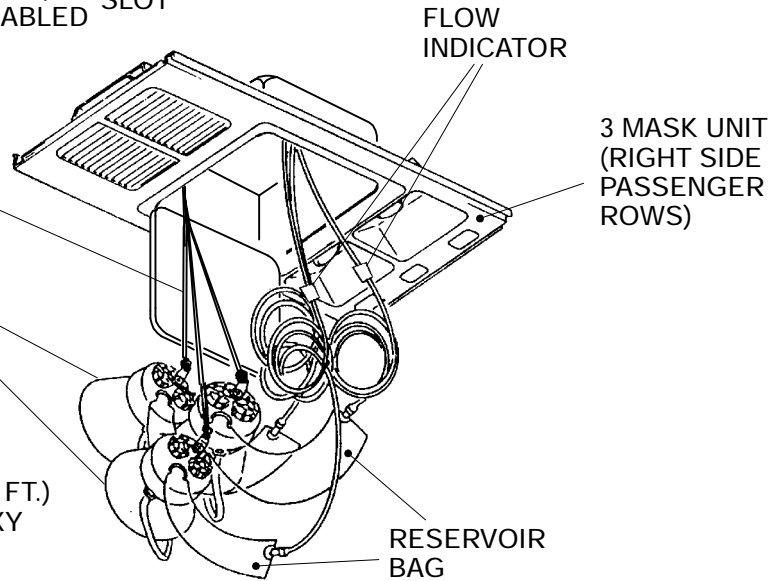

POTASSIUM  
SUPEROXIDE (KO<sub>2</sub>)  
GENERATOR  
• (13 MINUTES)  
• (22 MINUTES) <0071>

LANYARD  
(APPROX. 5 INCH)

MASKS

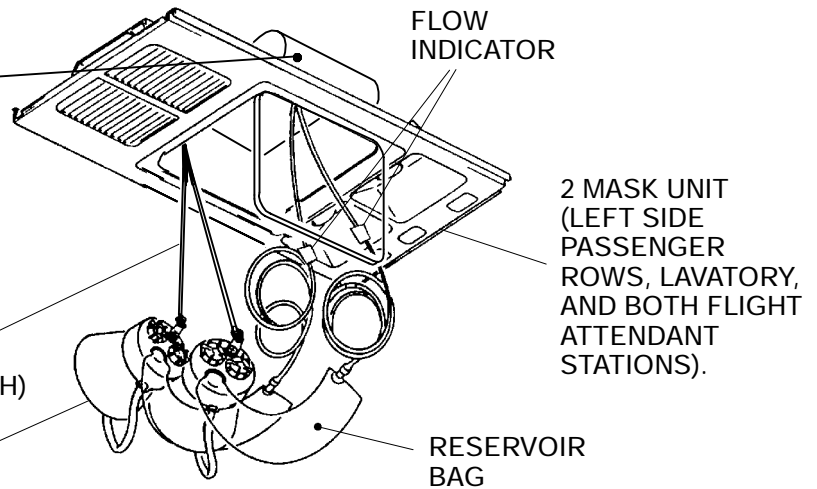

Passenger Oxygen System <MST>  
Figure 09-20-6

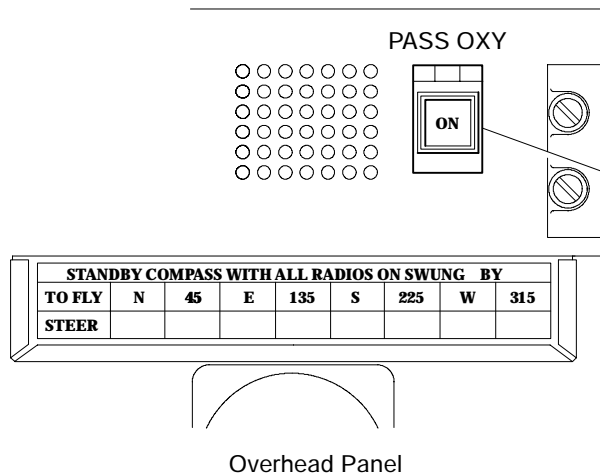

Overhead Panel

**Passenger Oxygen Override Switch/light (guarded)**

Normally blank (not on).  
Used when the passenger oxygen system auto-deploy has failed, or to override the auto-deploy system.

- Comes on white to indicate that the oxygen system has deployed.
- When pressed, electrically operates the latches on the oxygen compartment doors, which open to deploy the passenger O<sup>2</sup> masks.

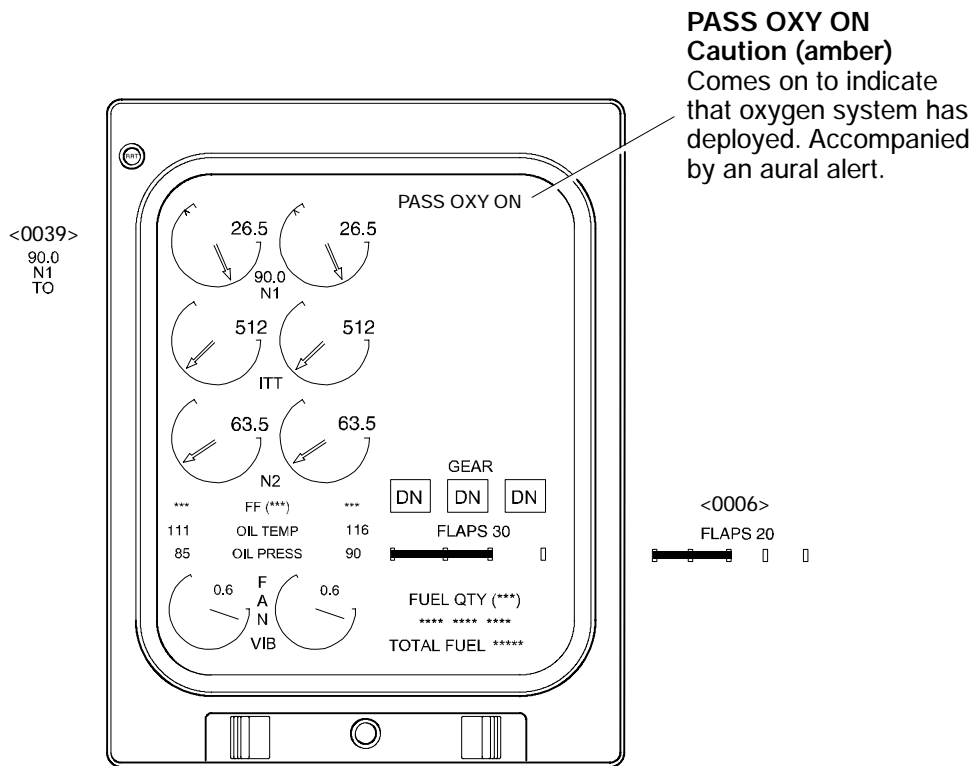

Primary Page

Passenger Oxygen – Control and EICAS Indication <MST>  
Figure 09-20-7

**I. Portable Oxygen System**

There are two portable oxygen bottles, with disposable masks, installed in the aircraft. One bottle is located near the flight attendant station and the other bottle is located in the right aft overhead bin. The portable oxygen bottles and masks are provided to supply oxygen to the crew or passengers during an emergency. The portable oxygen bottles can be used for protection against smoke and harmful gases or as therapeutic oxygen for first aid purposes.

The portable oxygen bottles allow the flight attendant to move about the passenger compartment during an emergency. Each cylinder has two regulator outlets which are color coded and pre-set to provide appropriate flow rates. An instruction decal located on the cylinder provides clear, easy to read operating instructions. The needle in the red band on the contents gauge, indicates that the bottle is fully charged.

**WARNING**

Take precautions to ensure that oxygen bottles do not come into contact with oil, grease, or other contaminants during handling. An explosion could result if this happens.

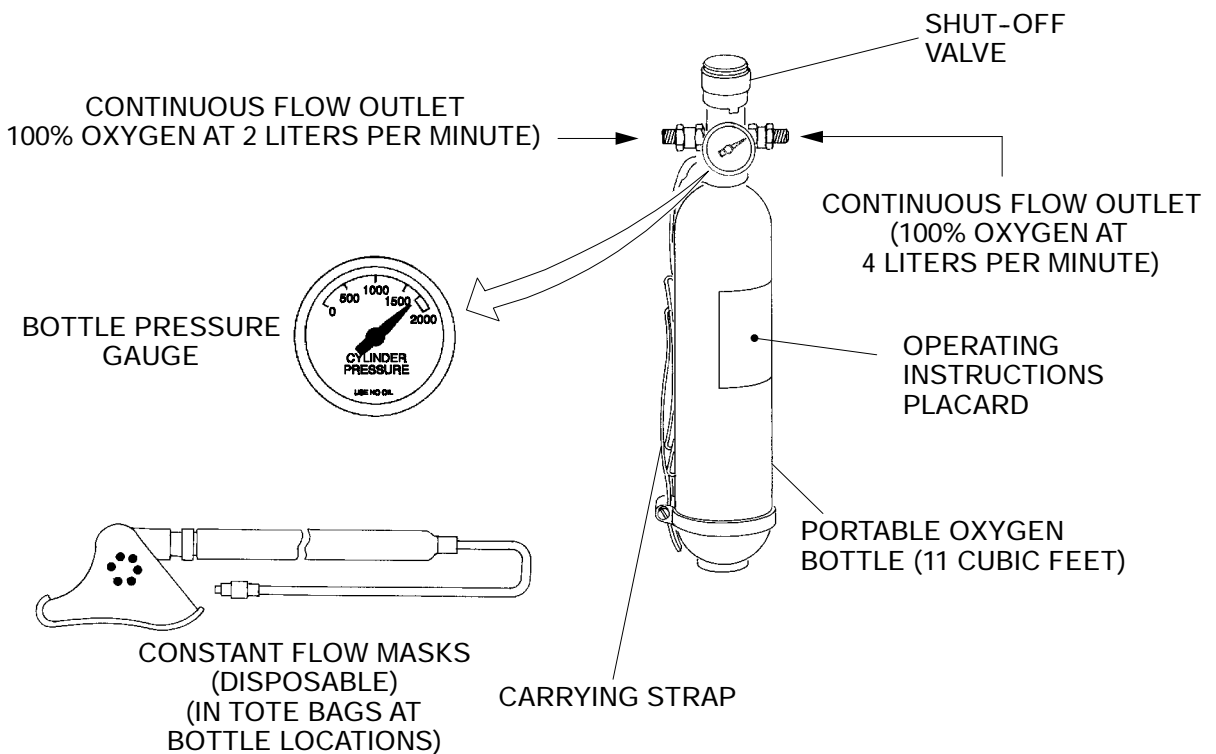

Portable Oxygen System  
Figure 09-20-8



**EMERGENCY EQUIPMENT  
Oxygen**

Vol. 1      09-20-16

REV 56, Jan 31/03

**J. System Circuit Breakers**

SYSTEM	SUB-SYSTEM	CB NAME	BUS BAR	CB PANEL	CB LOCATION	NOTE
Crew Oxygen System	Oxygen Indication	CREW OXYGEN MONITOR	DC BAT	2	P10	
Passenger Oxygen System	CPAM Deploy	PASS OXYGEN / AUTO DEPLOY			P11	
	Pass Oxy On Switch Deploy	PASS OXYGEN / MANUAL DEPLOY		1	P11	
	Latch Relay (RH)	PASS OXYGEN / RIGHT PASS		2	P12	
	Latch Relay (LH)	PASS OXYGEN / LEFT PASS		1	P12	

	<b>EMERGENCY EQUIPMENT</b> <b>Evacuation Devices</b>	Vol. 1	09-30-1
		REV 56, Jan 31/03	

## 1. EVACUATION DEVICES

A portable megaphone, flashlights, crash axe and escape ropes are provided to assist in emergency escape and aid in rescue operations. The megaphone is located in the right aft overhead bin. A flashlight is located behind each pilot seat, one in the wardrobe, one next to the flight attendant and one in the right aft overhead bin. The crash axe is located behind the copilot's seat. A flight compartment escape rope is located in the ceiling above the copilot. Cabin escape ropes are located just aft of each overwing emergency exit. An area on the top of the fuselage at the wing root is clearly marked as a break-in area for rescue crew emergency access to the cabin.

### A. Emergency Locator Transmitter

The emergency locator transmitter (ELT) is located in the aft equipment compartment and is automatically activated during an aircraft crash. The ELT transmits a standard swept tone on 121.5, and 243.0 MHz. The two position ELT switch is located in the flight compartment on the overhead panel and is labeled ARM/RESET and ON. The switch is used to test, arm and reset the unit. During normal flight operations, the ELT switch is in the ARM/RESET position. The ELT can be manually activated by selecting the ELT switch to ON. To reset the unit after it has been activated automatically, the switch is selected to the ON position, then back to the ARM/RESET position.

The satellite capable emergency locator transmitter (ELT) is located in the aft equipment compartment and is automatically activated during an aircraft crash. The ELT transmits a standard swept tone on 121.5, 243.0 and 406.0 MHz for satellites. The two position ELT switch is located in the flight compartment on the overhead panel and is labeled ARM/RESET and ON. The switch is used to test, arm and reset the unit. During normal flight operations, the ELT switch is in the ARM/RESET position. The ELT can be manually activated by selecting the ELT switch to ON. To reset the unit after it has been activated automatically, the switch is selected to the ON position, then back to the ARM/RESET position. <0092>

The satellite capable emergency locator transmitter (ELT) is located in the aft equipment compartment and is automatically activated during an aircraft crash. The ELT transmits a standard swept tone on 121.5, 243.0 and 406.0 MHz for satellites. The ELT switch is located in the flight compartment on the overhead panel and is labeled ARM/RESET, AUTO and MANUAL. The switch is spring-loaded from the ARM/RESET position to the AUTO position. During normal flight operations, the ELT switch is in the AUTO position which arms the unit. The ELT can be manually activated by selecting the ELT switch to MANUAL. The ARM/RESET position is used to turn the unit "off" once it has been activated either automatically or manually. <0016>

	<b>Flight Crew Operating Manual</b> <b>CSP A-013</b>	<b>MASTER</b>
--	---	---------------

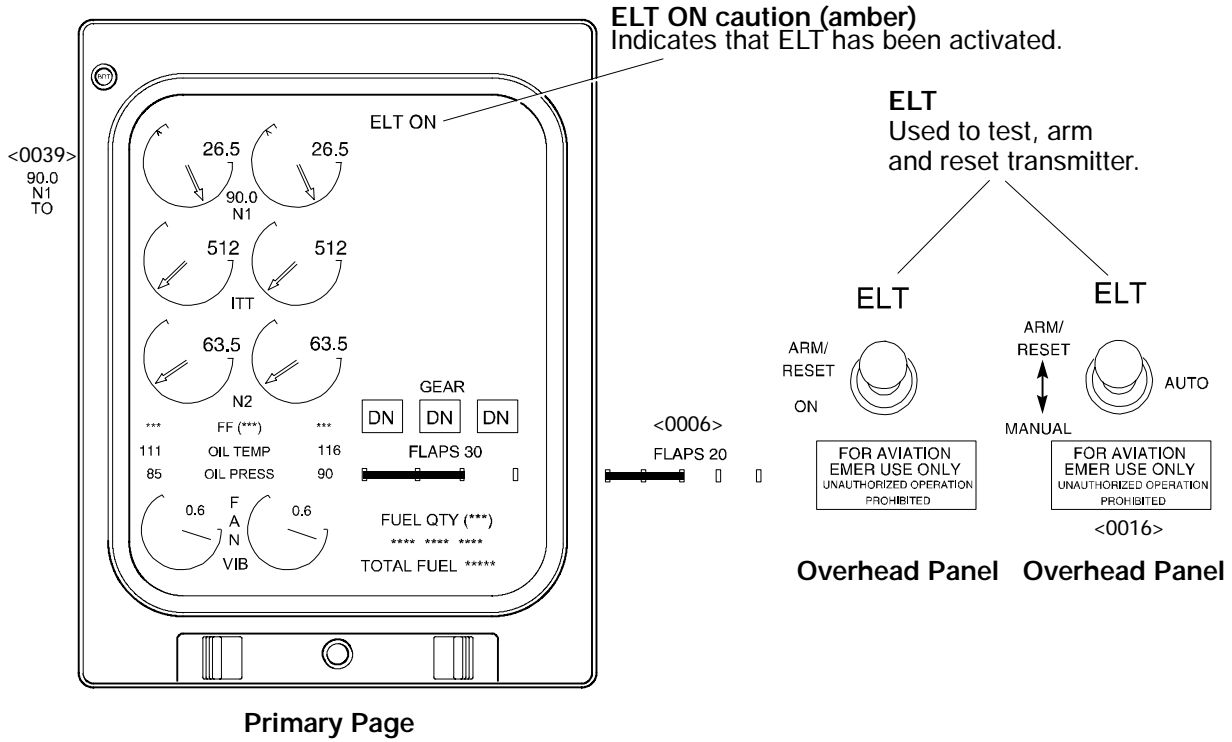

Emergency Locator Transmitter <MST>  
Figure 09-30-1

	<b>EMERGENCY EQUIPMENT</b> <b>Fire Fighting Equipment</b>	Vol. 1	09-40-1
		REV 56, Jan 31/03	

## 1. FIRE FIGHTING EQUIPMENT

Portable fire extinguishers and protective breathing equipment is provided for fighting fires which may occur in the flight or passenger compartment.

Portable fire extinguishers, fire protective gloves and protective breathing equipment is provided for fighting fires which may occur in the flight or passenger compartment.

### A. **Portable Halon Fire Extinguishers**

A hand-operated fire extinguisher containing Halon 1211 is installed in the flight compartment. Halon 1211 is effective on electrical, oil and fuel fires, and is suitable for use in cold weather. <0056>

There are three hand-operated fire extinguishers containing Halon 1211 installed in the aircraft. One extinguisher is located in the cockpit, one in the entrance storage compartment, and one on the right aft cabin bulkhead. Halon 1211 is effective on electrical, oil and fuel fires, and is suitable for use in cold weather.

There are four hand-operated fire extinguishers containing Halon 1211 installed in the aircraft. One extinguisher is located in the cockpit, one in the entrance storage compartment, one on the right fwd cabin bulkhead and one on the right aft cabin bulkhead. Halon 1211 is effective on electrical, oil and fuel fires, and is suitable for use in cold weather. <Tyrolean>

There are three hand-operated fire extinguishers installed in the aircraft. One Halon extinguisher is located in the cockpit and one Halon extinguisher is in the entrance storage compartment. A water fire extinguisher is located on the right aft passenger compartment bulkhead. Halon 1211 is effective on electrical, oil and fuel fires, and is suitable for use in cold weather. Water extinguishers are effective on wood, paper and fabric fires. <0067>

Operating instructions are on the bottle placard. Effective discharge time of a 2-1/2 pound Halon bottle is 8 to 15 seconds. After using a Halon extinguisher, promptly ventilate the compartment (after successfully extinguishing the fire) to reduce gasses produced by the fire and Halon.

## WARNING

Crew exposure to high levels of Halon vapors may result in dizziness, impaired coordination, and reduced mental sharpness. If a fire extinguisher is to be discharged in the flight compartment, all flight crew must wear oxygen masks with EMERGENCY selected (100% oxygen).

	<b>Flight Crew Operating Manual</b> <b>CSP A-013</b>	<b>MASTER</b>
--	---	---------------

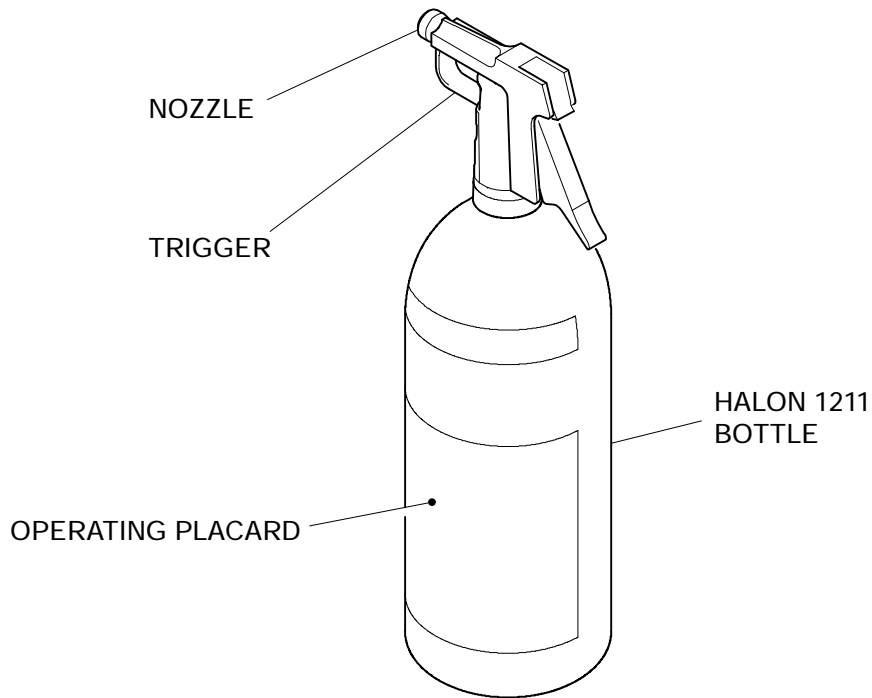

Portable Halon Fire Extinguisher  
Figure 09-40-1



	<b>EMERGENCY EQUIPMENT</b> <b>Fire Fighting Equipment</b>	Vol. 1	09-40-3
		REV 56, Jan 31/03	

**B. Portable Water Fire Extinguisher <0067>**

A portable water fire extinguisher is located at the aft bulkhead. Water is useful for extinguishing fires fueled by wood, paper and fabric. It does not have Halon's hazardous effect on people.

	<b>Flight Crew Operating Manual</b> <b>CSP A-013</b>	<b>MASTER</b>
--	---	---------------

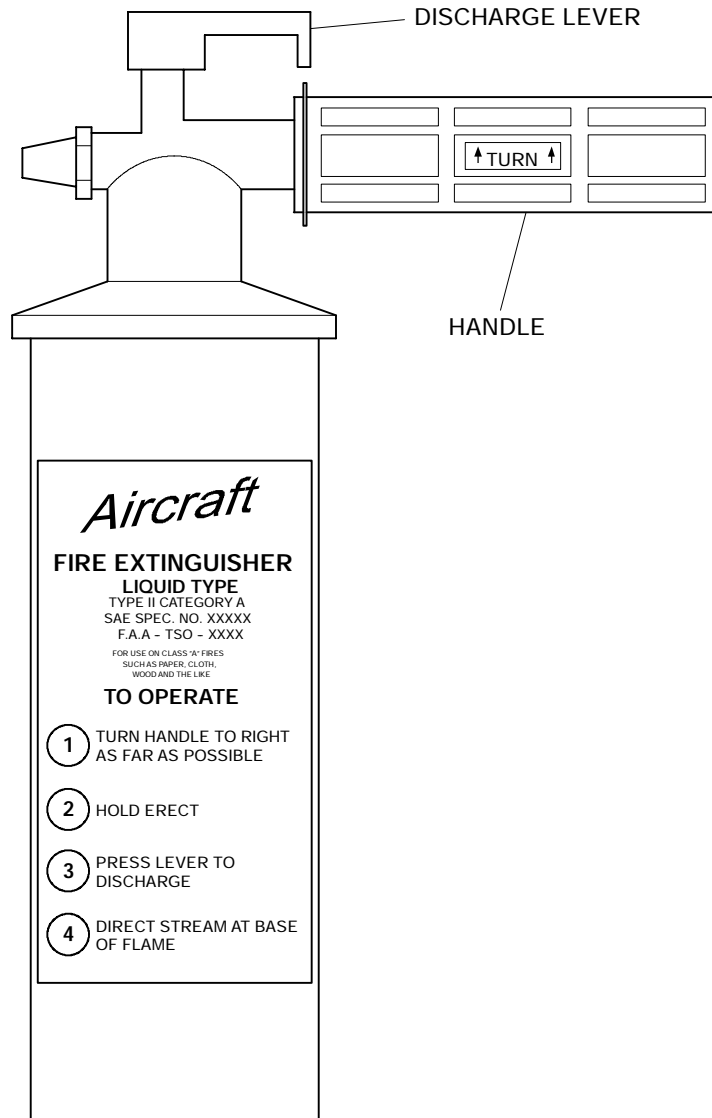

Portable Water Fire Extinguisher <0067>  
Figure 09-40-2

	<b>EMERGENCY EQUIPMENT</b> <b>Fire Fighting Equipment</b>	Vol. 1	09-40-5
		REV 56, Jan 31/03	

**C. Fire Protection Gloves**

Fire protection gloves are located in the forward storage compartment.

**D. Protective Breathing Equipment**

The protective breathing equipment consists of three protective breathing units (PBUs). The PBUs are self-contained smoke hoods with on-demand oxygen regeneration systems. The PBU'S prevent injury to crew members from smoke inhalation. Each PBU is in a vacuum-sealed bag, and is kept in a storage container with a tamper-proof seal. One PBU is installed in the flight compartment, one is in the wardrobe and one is on the right aft passenger compartment bulkhead. <0061><0062><0064>

The protective breathing equipment consists of three protective breathing units (PBUs). The PBUs are self-contained smoke hoods with on-demand oxygen cylinders. The PBU'S prevent injury to crew members from smoke inhalation. Each PBU is in a vacuum-sealed bag, and is kept in a storage container with a tamper-proof seal. One PBU is installed in the flight compartment, one is in the wardrobe and one is on the right aft passenger compartment bulkhead. <0063>

	<b>Flight Crew Operating Manual</b> <b>CSP A-013</b>	<b>MASTER</b>
--	---	---------------

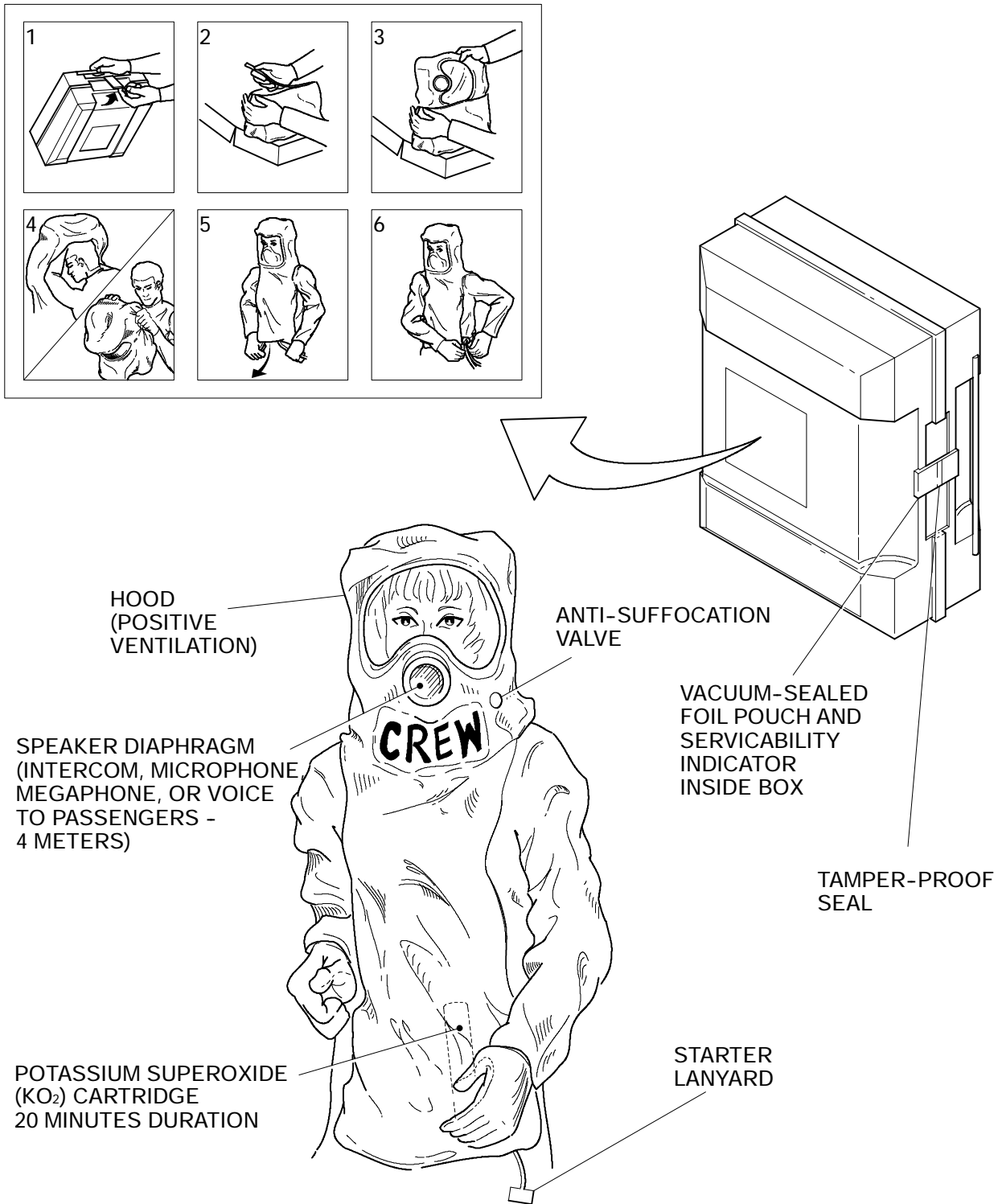

Protective Breathing Equipment <0061>  
Figure 09-40-3

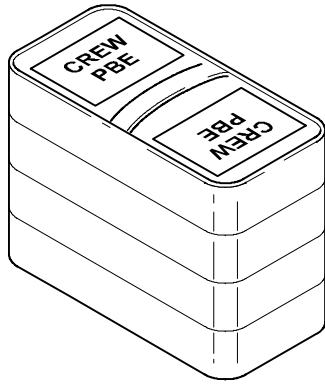

- OPERATING INSTRUCTIONS INSIDE CONTAINER
- PBE WITHIN VACUUM SEALED FOIL POUCH
- TAMPER PROOF SEAL ON LID

POTASSIUM SUPEROXIDE  
(KO<sub>2</sub>) CANISTER AND  
STARTER LANYARD  
15 MINUTE DURATION

HOOD (POSITIVE  
VENTILATION)

SPEAKER  
DIAPHRAGM  
(INTERCOM,  
MICROPHONE,  
MEGAPHONE)

TENSION  
STRAP

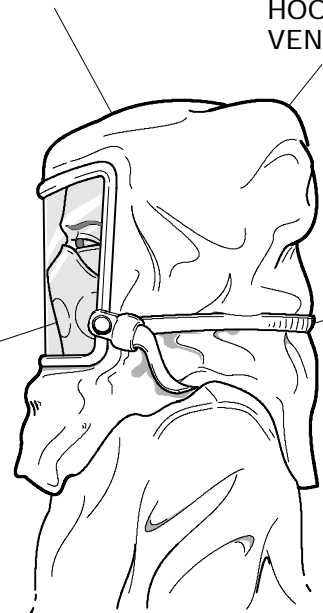

Protective Breathing Equipment <0062>  
Figure 09-40-4

TAMPER EVIDENT SEALS

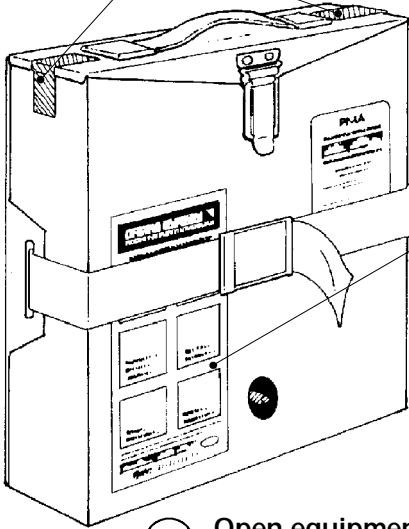

① **Open equipment container**

VACUUM-SEALED POUCH

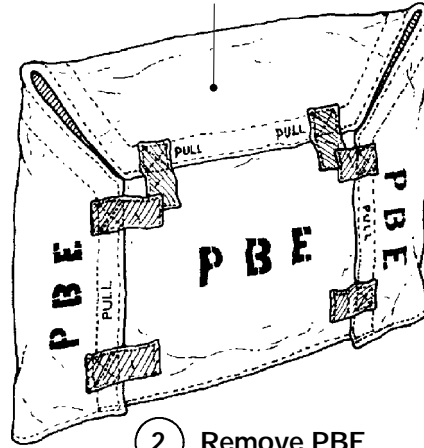

② **Remove PBE**

OXYGEN CYLINDERS

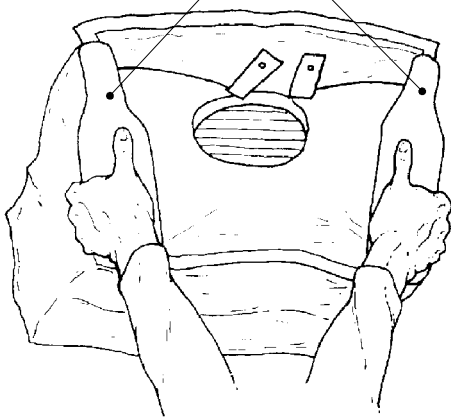

③ **Remove from pouch**  
Activate oxygen flow by snapping the two cylinders apart.

ACTIVATED HOOD



④ **Don hood**  
(Approximately 15 minutes of respiration protection)

Protective Breathing Equipment <0063>  
Figure 09-40-5

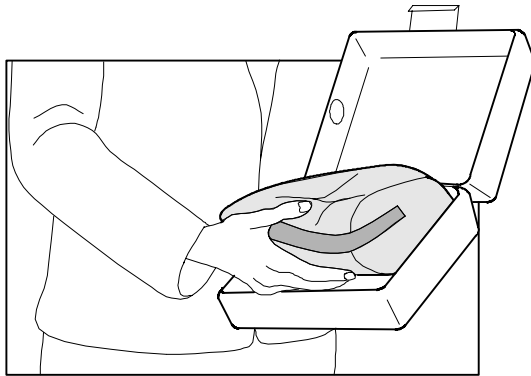

1. Remove device from storage case.

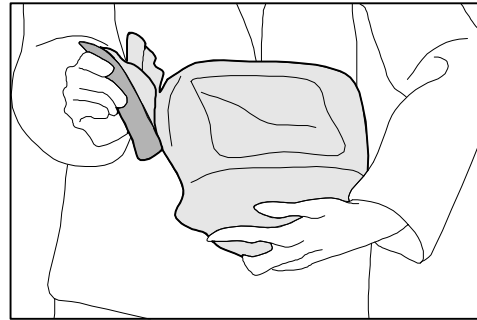

2. Tear off red pull strip and remove device from protective cover.

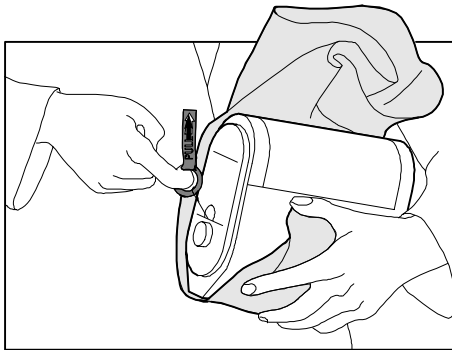

3. Pull activation ring, on the life support pack, in the direction indicated.

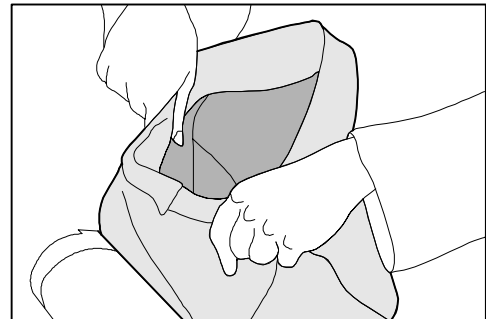

4. With the life support pack away from user, grasp hole in neck seal with thumbs, insert chin into hole and pull hood across face and over head.

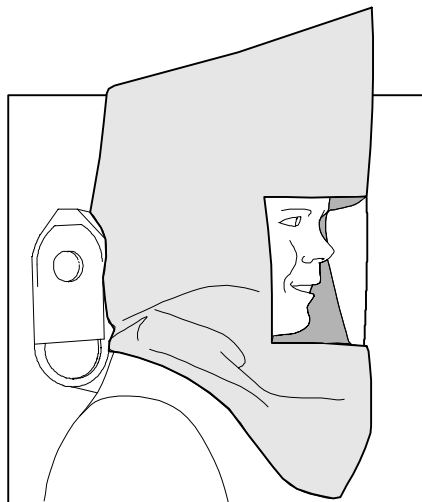

5. Pull hood down until headband firmly engages forehead (approximately 15 minutes of respiration protection).

Protective Breathing Equipment <0064>  
Figure 09-40-6



**EMERGENCY EQUIPMENT  
Fire Fighting Equipment**

**Vol. 1**

**09-40-10**

**REV 56, Jan 31/03**

THIS PAGE INTENTIONALLY LEFT BLANK

**Flight Crew Operating Manual  
CSP A-013**

**MASTER**



	<b>EMERGENCY EQUIPMENT</b> <b>Over Water Emergency Equipment</b>	Vol. 1	09-50-1
		REV 56, Jan 31/03	

**1. OVER WATER EMERGENCY EQUIPMENT**

A life vest is provided for each member of the flight crew. One life vest is stowed under each pilot seat, one life vest is stowed adjacent to the 3rd crew seat and one is adjacent to each flight attendants seat.

Each life vest includes a manual and an oral inflation system, a locator light, and a system for automatic battery plug removal during life vest deployment.

Each passenger seat cushion serves as a floatation device.

	<b>Flight Crew Operating Manual</b> <b>CSP A-013</b>	<b>MASTER</b>
--	---	---------------

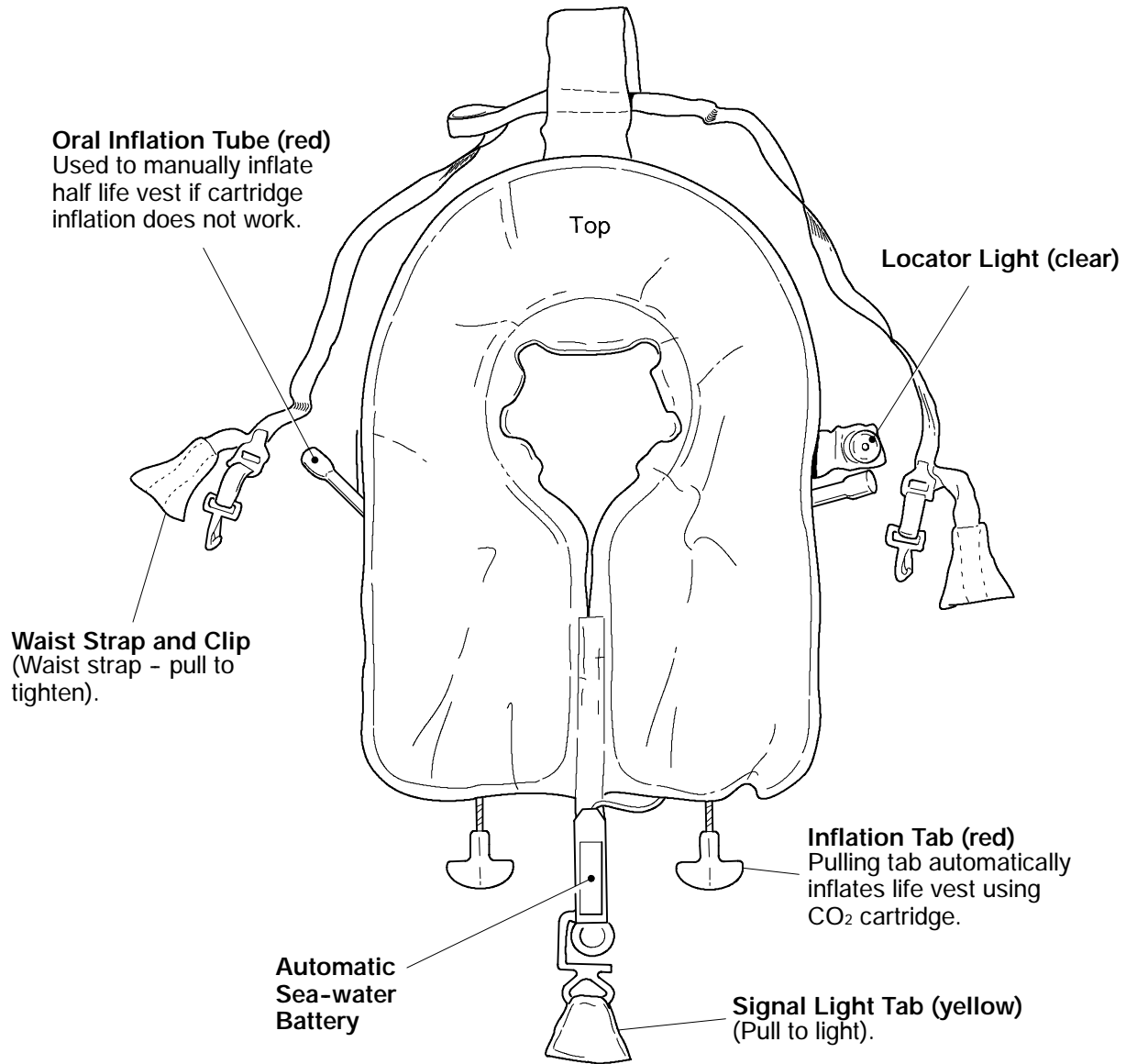

Life Vest  
Figure 09-50-1



1. Locate and remove the life vest.



2. Put the life vest over head...

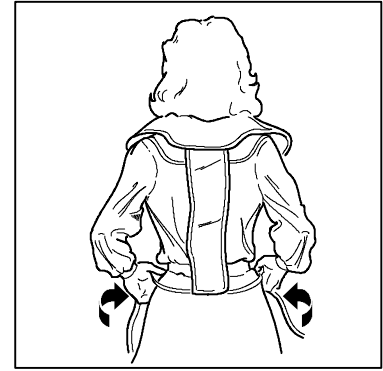

3. ...with the back piece behind.



4. Fasten rings to catch.



5. Pull straps tight.



6. Jerk down on red inflation tabs.



7. Should it become necessary, life vest can be orally inflated by blowing into red oral inflation tubes.



Inflate life vest just before leaving the airplane!  
If using overwing emergency exit inflate life vest when on the wing.

Life Vest Operation  
Figure 09-50-2



**EMERGENCY EQUIPMENT  
Over Water Emergency Equipment**

**Vol. 1**

**09-50-4**

**REV 56, Jan 31/03**

THIS PAGE INTENTIONALLY LEFT BLANK

**Flight Crew Operating Manual  
CSP A-013**

**MASTER**