

CHAPTER 13 – FUEL SYSTEM

	Page
TABLE OF CONTENTS	13-00
Table of Contents	13-00-1
INTRODUCTION	13-10
Introduction	13-10-1
FUEL STORAGE	13-20
Fuel Storage	13-20-1
Collector Tanks	13-20-1
Venting	13-20-1
FUEL MANAGEMENT	13-30
Fuel Management	13-30-1
Fuel Transfer	13-30-1
Fuel Crossflow	13-30-1
System Circuit Breakers	13-30-8
FUEL DISTRIBUTION	13-40
Fuel Distribution	13-40-1
System Circuit Breakers	13-40-5
REFUELING AND DEFUELING	13-50
Refueling and Defueling	13-50-1
Control Panel	13-50-4
System Circuit Breakers	13-50-7
FUEL QUANTITY GAUGING	13-60
Fuel Quantity Gauging System	13-60-1
Magnetic Level Indicators	13-60-5
System Circuit Breakers	13-60-8

LIST OF ILLUSTRATIONS

INTRODUCTION		
Figure 13-10-1	Fuel System - General	13-10-2
FUEL STORAGE		
Figure 13-20-1	Collector Tank and Vent System - General	13-20-2
FUEL MANAGEMENT		
Figure 13-30-1	Fuel System Schematic - General	13-30-3



**FUEL SYSTEM
Table of Contents**

Vol. 1

13-00-2

REV 56, Jan 31/03

Figure 13-30-2	Fuel Control Panel - General	13-30-4
Figure 13-30-3	Fuel System EICAS Indications	13-30-5
Figure 13-30-4	Fuel System Controls - Synoptic Page Indications	13-30-6

FUEL DISTRIBUTION

Figure 13-40-1	Standby Fuel Feed System	13-40-2
Figure 13-40-2	Standby Fuel Feed System - EICAS Messages	13-40-3
Figure 13-40-3	Standby Fuel Feed System - Fuel Synoptic Page Indications	13-40-4

REFUELING AND DEFUELING

Figure 13-50-1	Refuel/Defuel System	13-50-2
Figure 13-50-2	Fuel System Computer	13-50-3
Figure 13-50-3	Refuel/Defuel Control Panel	13-50-5

FUEL QUANTITY GAUGING

Figure 13-60-1	Refuel/Defuel - EICAS Messages	13-60-2
Figure 13-60-2	Refuel/Defuel System - Fuel Synoptic Page Indications	13-60-3
Figure 13-60-3	Fuel System - Menu Page	13-60-4
Figure 13-60-4	Magnetic Level Indicators	13-60-6
Figure 13-60-5	Pitch and Roll Inclometers	13-60-7

	FUEL SYSTEM Introduction	Vol. 1	13-10-1
		REV 56, Jan 31/03	

1. INTRODUCTION

The fuel system consists of three integral tanks within the wing box structure. Ejector pumps and electrical boost pumps supply fuel to each engine. The fuel system also provides facilities for pressure refueling/defueling and gravity refueling/defueling. Power and gravity crossflow systems allow fuel transfer between wing tanks and also provides fuel to the auxiliary power unit (APU).

A fuel system computer (FSC) automatically controls refueling, powered fuel crossflow and fuel transfer. The FSC also measures the fuel quantity and temperature for display on the engine indication and crew alerting system (EICAS).

The EICAS FUEL synoptic page shows a diagram of the fuel distribution system. Operation of the ejectors, pumps and shutoff valves are graphically displayed. Any fault detected by the FSC is annunciated in the form of visual and/or aural messages. Faults are also displayed on the refuel/defuel panel in the form of fault codes.

	Flight Crew Operating Manual CSP A-013	MASTER
--	---	---------------

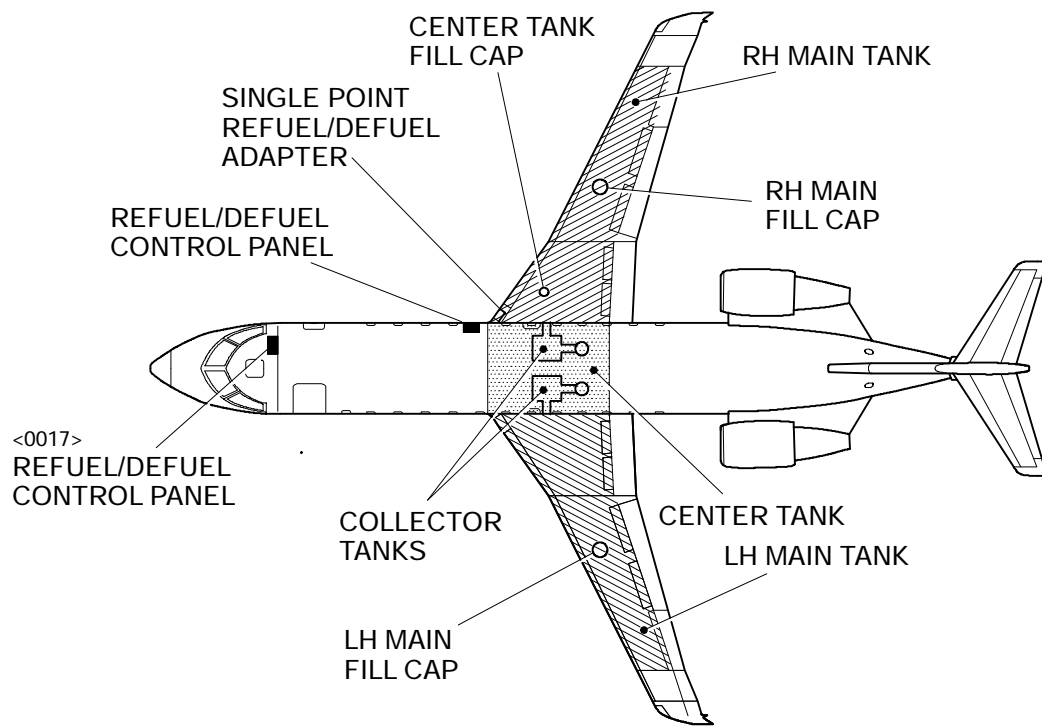

Fuel System – General <MST>
Figure 13-10-1

1. FUEL STORAGE

Fuel is stored in two main wing tanks and one center wing tank. In flight, as the wing tank fuel quantity decreases, the FSC will automatically transfer fuel from the center tank to the wing tanks to maintain lateral balance.

A. Collector Tanks

Two collector tanks are located in the forward section of the center wing tank. Fuel from each wing tank is fed under pressure to its respective collector tank by scavenge ejectors. The collector tank capacity is 10 gallons (38 liters) and when the tank is full, excess fuel is vented back to the respective wing tank. Fuel can also be fed from the wing tanks to the associated collector tank by gravity. There is no migration of fuel from the center tank into the collector tanks. A main fuel ejector in each collector tank is immersed in fuel and is used to ensure a positive supply of fuel to the engines. The boost pumps normally supply fuel to the engines for start.

B. Venting

The tanks are vented through interconnecting vent lines to NACA scoops located on the lower surface of each wing.

In flight, the NACA scoops supply ram air to slightly pressurize the wing tanks.

On the ground, the tanks are vented to atmosphere through the NACA scoops to prevent pressure buildup within the tanks caused by the refueling process or from thermal expansion of the fuel.

NOTE

During climb, fuel could enter the center tank from the vent system. This fuel can cause erroneous center tank quantity indications as high as 300 lbs (135kg).

Fuel tank capacities for pressure fueling operation:

TANK	USABLE FUEL	UNUSABLE FUEL	TOTAL FUEL
Left Wing	4760 lb (2159 kg)	20.4 lb (9.2 kg)	4780.4 lb (2168.2 kg)
Right Wing	4760 lb (2159 kg)	20.4 lb (9.2 kg)	4780.4 lb (2168.2 kg)
Center	4998 lb (2267 kg)	6.8 lb (3 kg)	5004.8 lb (2270 kg)
Total	14518 lb (6585.2 kg)	47.6 lb (21.6 kg)	14565 lb (6606.8 kg)

Fuel tank capacities for gravity fueling operation:

TANK	USABLE FUEL	UNUSABLE FUEL	TOTAL FUEL
Left Wing	4488 lb (2036 kg)	20.4 lb (9.2 kg)	4508.4 lb (2145.2 kg)
Right Wing	4488 lb (2036 kg)	20.4 lb (9.2 kg)	4508.4 lb (2145.2 kg)
Center	4930 lb (2236 kg)	6.8 lb (3 kg)	4936.8 lb (2239 kg)
Total	13906 lb (6308 kg)	47.6 lb (21.6 kg)	13953.6 lb (6329 kg)

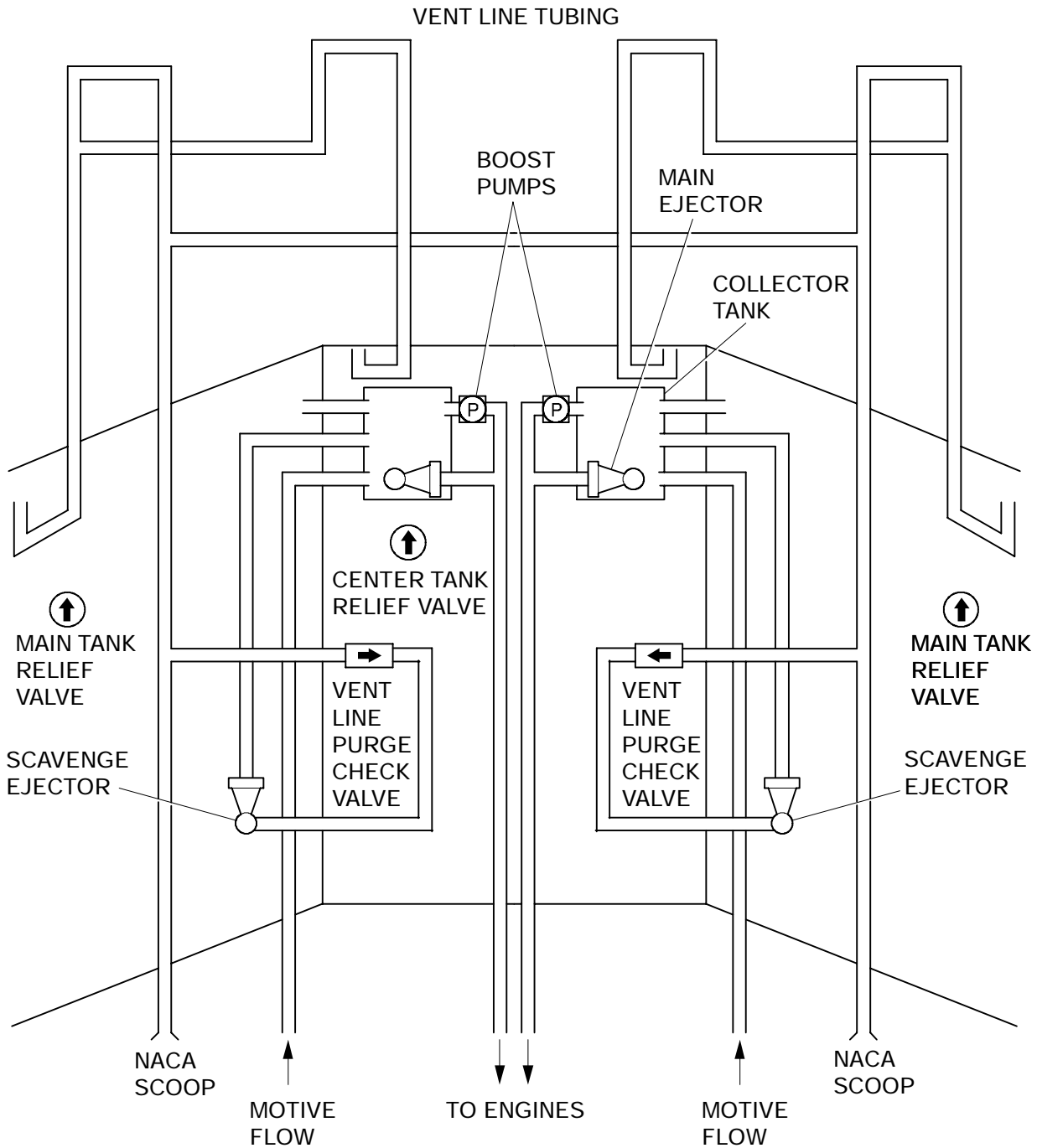

Collector Tank and Vent System – General
Figure 13-20-1

	FUEL SYSTEM Fuel Management	Vol. 1	13-30-1
		REV 56, Jan 31/03	

1. FUEL MANAGEMENT

Fuel management is accomplished by fuel transfer from the center tank to the wing tanks and by fuel crossflow from one wing tank to the other wing tank.

A. Fuel Transfer

Fuel transfer from the centre tank to the wing tanks is provided by transfer ejector pumps to maintain the wing tanks at full capacity as long as possible. This is an automatic function with no manual control. The ejectors are powered by fuel pressure tapped from the engine supply lines via the fuel transfer shutoff valves which are automatically controlled by the fuel system computer (FSC). The FSC commands the respective transfer shutoff valve to open when the associated wing tank fuel quantity falls below 94% of full, and commands it to close when the tank quantity reaches 97%. The FSC will cycle the transfer system on and off until the center tank is empty.

If the fuel imbalance between the wing tanks exceeds 400 lbs (181 kg), a FUEL IMBALANCE caution message is displayed on the EICAS primary page. If the total fuel quantity is less than 900 lbs (408 kg) the fuel quantity indication on the primary page turns amber.

Effectivity:

- Airplanes 7002, 7042 and subsequent. Aircraft 7003 to 7081 incorporating SB 601R-28-015

If the fuel imbalance between the wing tanks exceeds 800 lbs (360 kg), a FUEL IMBALANCE caution message is displayed on the EICAS primary page. If the total fuel quantity is less than 900 lbs (408 kg) the fuel quantity indication on the primary page turns amber.

If the fuel imbalance between the wing tanks exceeds 800 lbs (360 kg), a FUEL IMBALANCE caution message is displayed on the EICAS primary page and both wing tank quantity indicators turn amber. If one wings fuel quantity is less than 450 lbs (204 kg), then that wings fuel quantity indicator will turn amber.<0039>

In the event of wing tank gauging failure, the FSC will use the high level sensors, located at the top of each tank, to control the fuel transfer operations.

B. Fuel Crossflow

To correct fuel imbalance and to maintain aircraft lateral stability, the FSC automatically initiates fuel crossflow upon detecting a fuel imbalance between wing tanks. The crossflow/APU pump located within the center tank provides powered crossflow in either automatic or manual mode.

In automatic mode, the FSC controls the crossflow operation. If the computer detects a fuel imbalance between the wing tanks of 200 lbs (90 kg), the crossflow/APU pump is activated automatically and the required crossflow shutoff valve is opened to correct the fuel imbalance. Crossflow operations continue until 50 lb (23kg) imbalance is reached.

	Flight Crew Operating Manual CSP A-013	MASTER
--	---	---------------



**FUEL SYSTEM
Fuel Management**

Vol. 1

13-30-2

REV 56, Jan 31/03

The flight crew can override the automatic function by selecting the XFLOW, AUTO OVERRIDE switchlight and the required (L or R) XFLOW valve switchlight on the Fuel Control Panel.

If the powered crossflow system fails, the flight crew can select the GRAVITY XFLOW switchlight on the Fuel Control Panel. This will open the gravity shutoff valve to allow fuel transfer by gravity between wing tanks. Gravity crossflow can also be enhanced by using a sideslip maneuver.

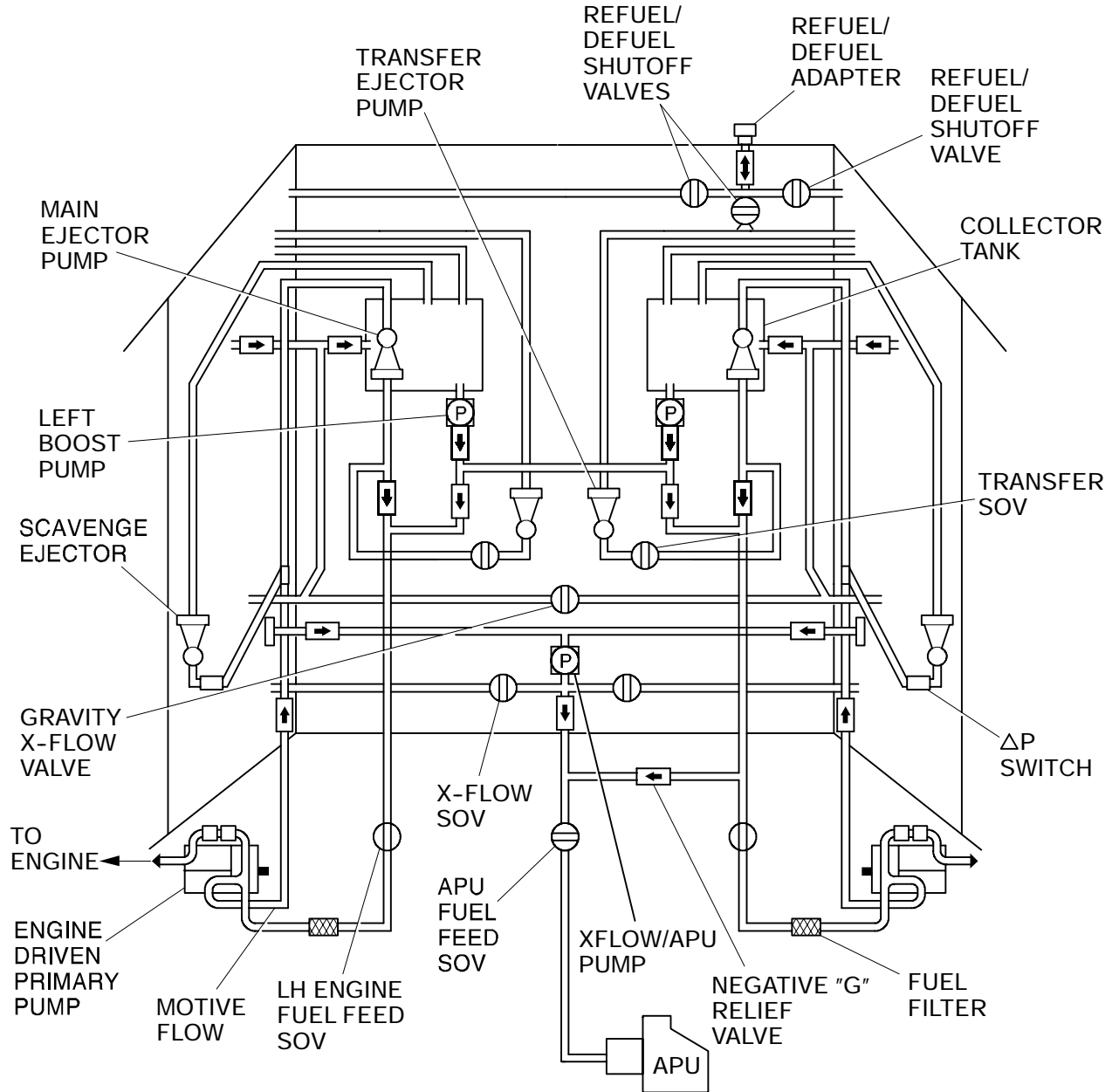

Fuel System Schematic – General
Figure 13-30-1

**GRAVITY/XFLOW X
switch/light**

- Pressed in - Opens the balance line SOV, OPEN light comes on.
- Pressed out - Closes the balance line SOV, OPEN light goes out.
- FAIL light comes on to indicate that the balance line SOV is not in the commanded position.

AUTO OVERRIDE switch/light

- Pressed in - Crossflow/APU pump is armed for manual crossflow, automatic crossflow is disabled. MANUAL light goes on.
- Pressed out - Crossflow/APU pump is disarmed for manual crossflow, automatic crossflow is enabled. MANUAL light goes out.

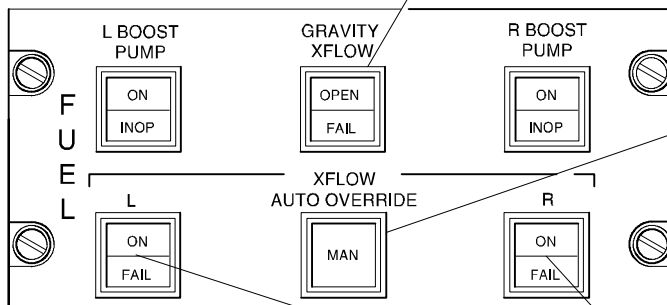

**Fuel Control Panel
Overhead Panel**

**L/R XFLOW switch/lights
(With AUTO OVERRIDE switch/light
pressed in, manual mode.)**

- Pressed in - Respective crossflow SOV opens and crossflow/APU pump goes on, ON light comes on.
- Pressed out - Respective crossflow SOV closes and crossflow/APU pump goes off, ON light goes out.

**(With AUTO OVERRIDE switch/light
pressed out, automatic mode.)**

- ON light comes on to indicate that the respective SOV is open and the crossflow/APU pump is on.
- FAIL light comes on to indicate that the respective crossflow SOV is not in the commanded position or the crossflow/APU pump fails to go on with the left or right crossflow SOV selected open either manually or automatically.

Fuel Control Panel – General
Figure 13-30-2

XFLOW/APU PUMP caution (amber)
Comes on to indicate that the crossflow/APU pump has failed.

L, R MAIN EJECTOR caution (amber)
Comes on to indicate low fuel pressure at respective main ejector with respective engine running.

L, R AUTO XFLOW ON status (white)
Comes on to indicate that the automatic fuel crossflow is operating to the respective side.

MAN XFLOW status (white)
Comes on to indicate that manual crossflow has been selected.

L, R XFLOW ON status (white)
Comes on to indicate that the respective crossflow SOV is manually selected open.

GRAV XFLOW FAIL status (white)
Comes on to indicate that the gravity crossflow SOV has failed.

L, R XFER SOV caution (amber)
Comes on to indicate that respective power transfer SOV has failed.

L, R XFLOW SOV caution (amber)
Comes on to indicate that respective crossflow SOV has failed.

FUEL IMBALANCE caution (amber)
Comes on to indicate that a fuel quantity imbalance of > 800 lb / 360 kg <0001> exists between the left and right tanks.

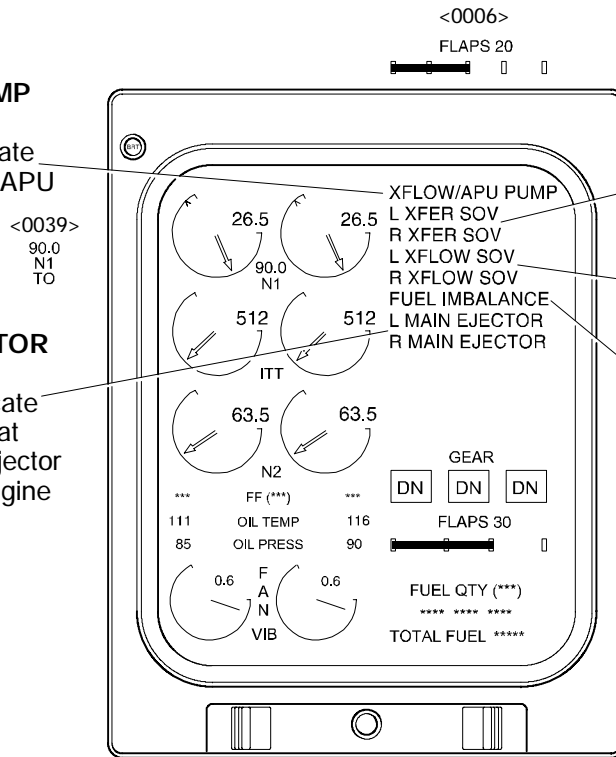

Primary Page

GRAV XFLOW OPEN advisory (green)
Comes on to indicate that the gravity crossflow SOV is open

<0039>
<7.2>

AUTO XFLOW INHB status (white)
Comes on to indicate that autobalance fuel crossflow is inhibited.

<0039>
C TEMP 23°C

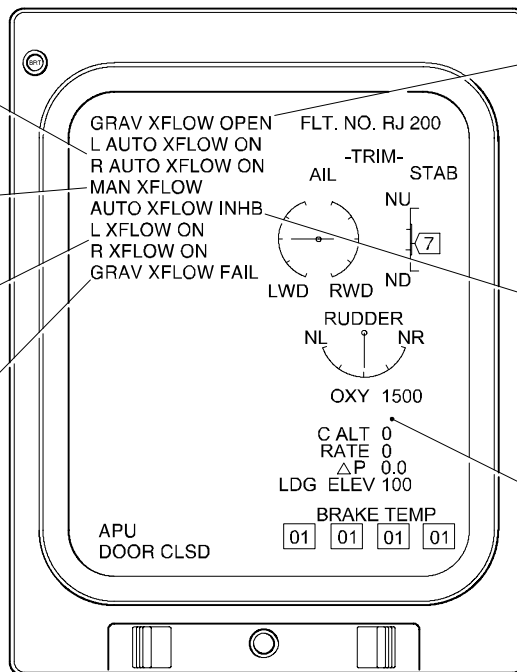

Status Page

Fuel System EICAS Indications <MST>
Figure 13-30-3

LH, RH Transfer Ejectors

- Green - Respective transfer ejector operating at normal pressure with fuel in centre tank.
- White - Centre tank is empty or respective transfer SOV is closed or respective engine not running.
- Amber - Low pressure at respective transfer ejector with respective engine running, respective transfer SOV opened and centre tank not empty.
- Half Intensity Magenta - Invalid data.

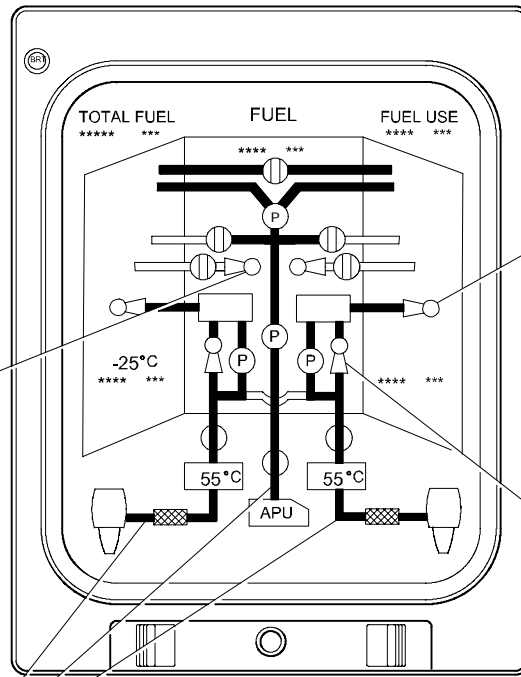

FUEL Page

LH, RH Scavenge Ejectors

- Green - Respective scavenge ejector operating at normal pressure.
- White - Respective engine not running.
- Amber - Respective scavenge ejector operating at low pressure with respective engine running.
- Half Intensity Magenta - Invalid data.

LH, RH Main Ejectors

- Green - Respective main ejector operating at normal pressure.
- White - Respective engine not running.
- Amber - Low pressure at respective main ejector with respective engine running.
- Half Intensity Magenta - Invalid data.

Fuel Lines

- Green - Indicates normal fuel flow through respective fuel line.
- Amber - Fuel flow in respective fuel line is restricted by failure of respective fuel feed SOV and/or fuel pump and/or ejector and/or fuel filter.
- Red - Indicates a fire in the respective engine or APU with respective fuel feed SOV failed at open or at mid position (applicable only to the fuel lines downstream of the engine and APU fuel feed SOVs).

Fuel System Controls – Synoptic Page Indications <MST>
Figure 13-30-4 Sheet 1

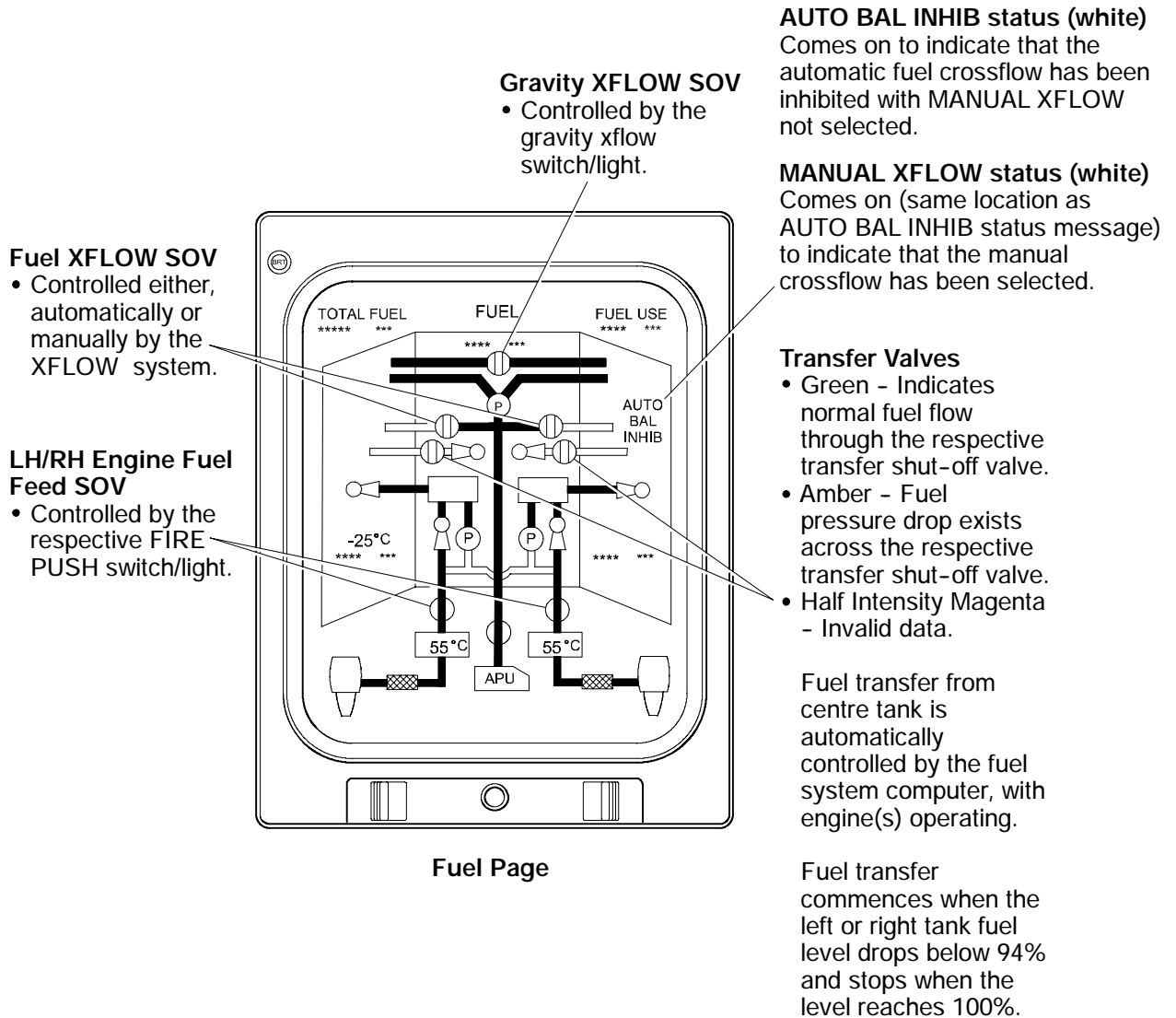

Fuel Page

Fuel System Controls – Synoptic Page Indications <MST>
Figure 13-30-4 Sheet 2



**FUEL SYSTEM
Fuel Management**

Vol. 1 13-30-8

REV 56, Jan 31/03

C. System Circuit Breakers

SYSTEM	SUB-SYSTEM	CB NAME	BUS BAR	CB PANEL	CB LOCATION	NOTES
Fuel System	APU/Transfer Fuel Pump	XFER/APU XFER SOV	DC BAT	1	N9	
		XFER/APU FUEL PUMP			N10	
		XFER/APU CONT			N11	
		XFER/APU APU ECU			N12	
	Fuel Control	XFLOW SOV			M8	
		GRAV XFLOW	DC ESS	4	B9	

	FUEL SYSTEM Fuel Distribution	Vol. 1	13-40-1
		REV 56, Jan 31/03	

1. FUEL DISTRIBUTION

Fuel is distributed to each engine from a respective side collector tank which is an integral part of the center wing tank. Two scavenge ejectors, located at the lowest part of each wing tank, supplies fuel to each collector tank to keep it in a full condition. The collector tank is designed to maintain engine fuel feed under all normal and transient flight maneuvering. A main ejector, within each collector tank, supplies fuel to the respective side engine. The main and scavenge ejectors are powered by pressurized fuel tapped from the motive flow line of the respective engine fuel pump.

For engine start, a boost pump connected to each collector tank, is selected ON from the fuel control panel. The boost pumps supply fuel to their respective engines. The control panel is used to control and monitor boost pump operation.

The fuel output pressure from the main ejector is monitored by a pressure switch and when the output pressure is sufficient to supply the engines, the boost pumps are automatically turned off. The boost pumps will remain in standby mode with the engines running, as a back up to the main ejectors in the event of a failure. Each boost pump is capable of feeding both engines.

The XFLOW/APU pump supplies fuel to the APU when the PWR FUEL switch on the APU control panel is selected. In the event of a XFLOW/APU pump failure, the APU can be supplied fuel from the right engine fuel feed manifold.

In the event of a fire, fuel flow to the engine or APU is terminated by the closure of a fuel shut-off valve when the associated fire push switchlight is selected.

	Flight Crew Operating Manual CSP A-013	MASTER
--	---	---------------

L/R BOOST PUMP switch/lights

- Pressed in - For engine start, both boost pumps are activated. With both engines running, the pumps remain armed, but will automatically come on, when low fuel pressure is detected in any engine feed line. The switch/lights show ON when the pumps are operating.
- Pressed out - The boost pump is disarmed on the respective side.
- INOP light comes on to indicate that a low pump pressure has been detected, the respective boost pump has not been armed, or has failed.

PWR FUEL

Used to control APU fuel pump.

- PUMP FAIL (amber) light Indicates that APU fuel pump has failed.
- SOV FAIL (amber) light Indicates that the APU fuel shut-off valve has failed.

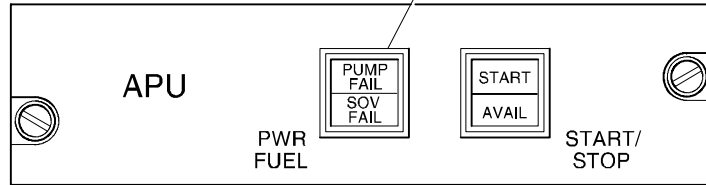

APU Control Panel Overhead Panel

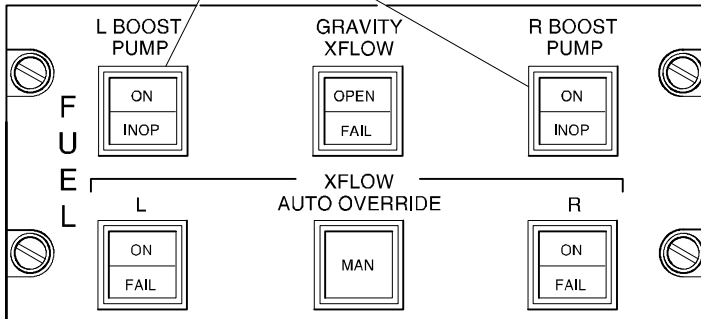

Fuel Control Panel Overhead Panel

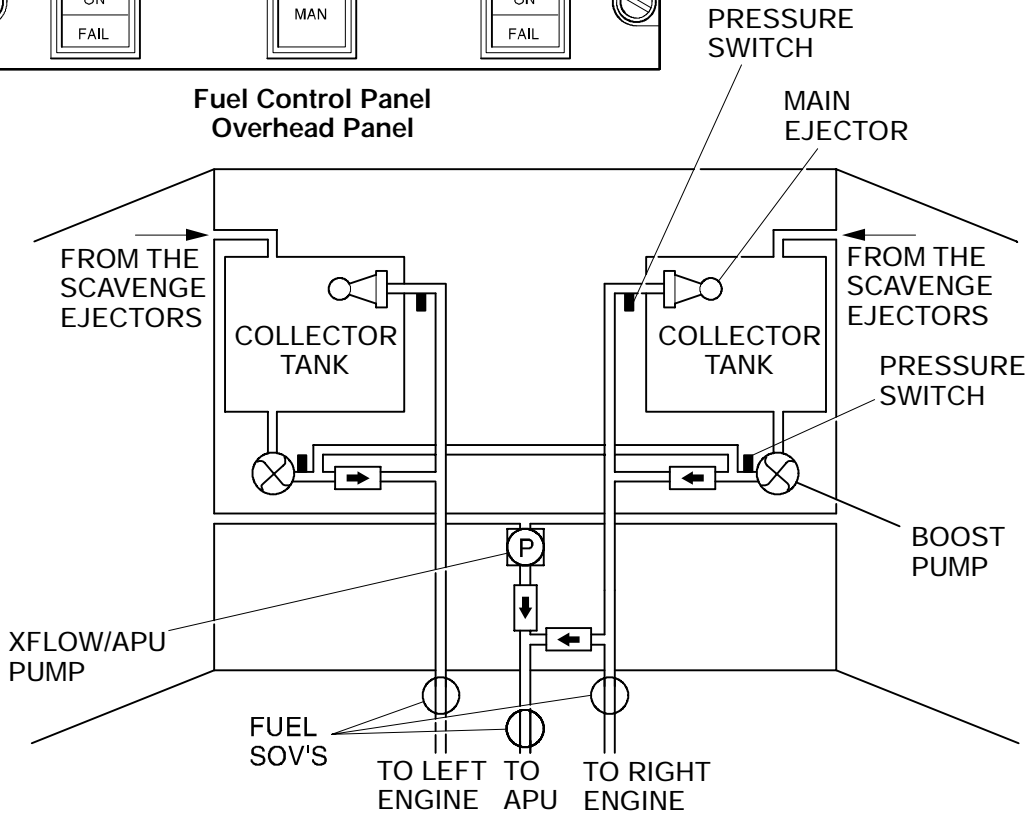

Standby Fuel Feed System
Figure 13-40-1

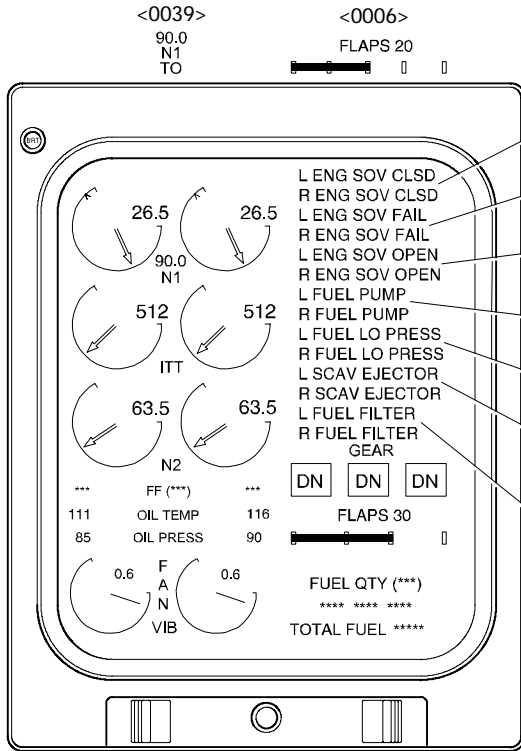

Primary Page

L,R ENG SOV CLSD caution (amber)
Comes on to indicate that respective engine fuel feed SOV is closed with no engine-fire condition.

L,R ENG SOV FAIL caution (amber)
Comes on to indicate that respective engine fuel feed SOV has failed.

L,R ENG SOV OPEN caution (amber)
Comes on to indicate that respective engine fuel feed SOV is not closed 10 seconds after an engine-fire condition.

L,R FUEL PUMP caution (amber)
Comes on to indicate that respective engine boost pump has failed.

L,R FUEL LO PRESS caution (amber)
Comes on at 5 psig to indicate that a low fuel pressure condition (at the engine inlet) has been detected.

L,R SCAV EJECTOR caution (amber)
Comes on to indicate low fuel pressure at respective scavenge ejector with respective engine running.

L,R FUEL FILTER caution (amber)
Comes on to indicate that a fuel pressure drop exists across respective fuel filter.

L,R ENG SOV CLSD advisory (green)
Comes on to indicate that respective engine fuel feed SOV is closed with no engine-fire condition.

L,R FUEL PUMP ON advisory (green)
Comes on to indicate that respective fuel boost pump is operating.

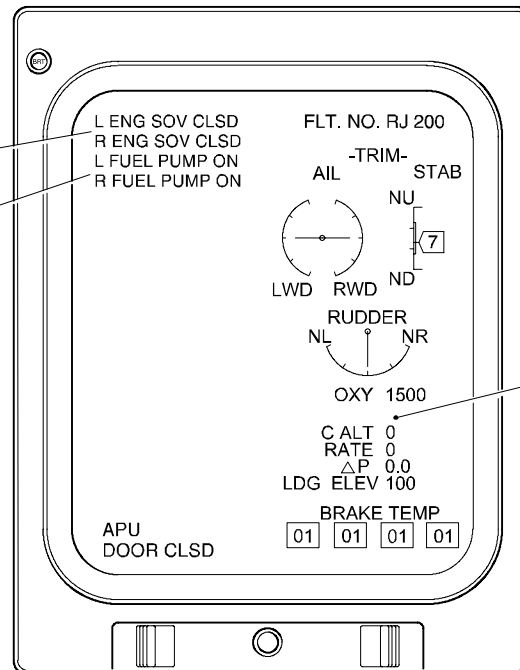

Status Page

<0039>
7.2

<0039>
C TEMP 23°C

Standby Fuel Feed System - EICAS Messages <MST>
Figure 13-40-2

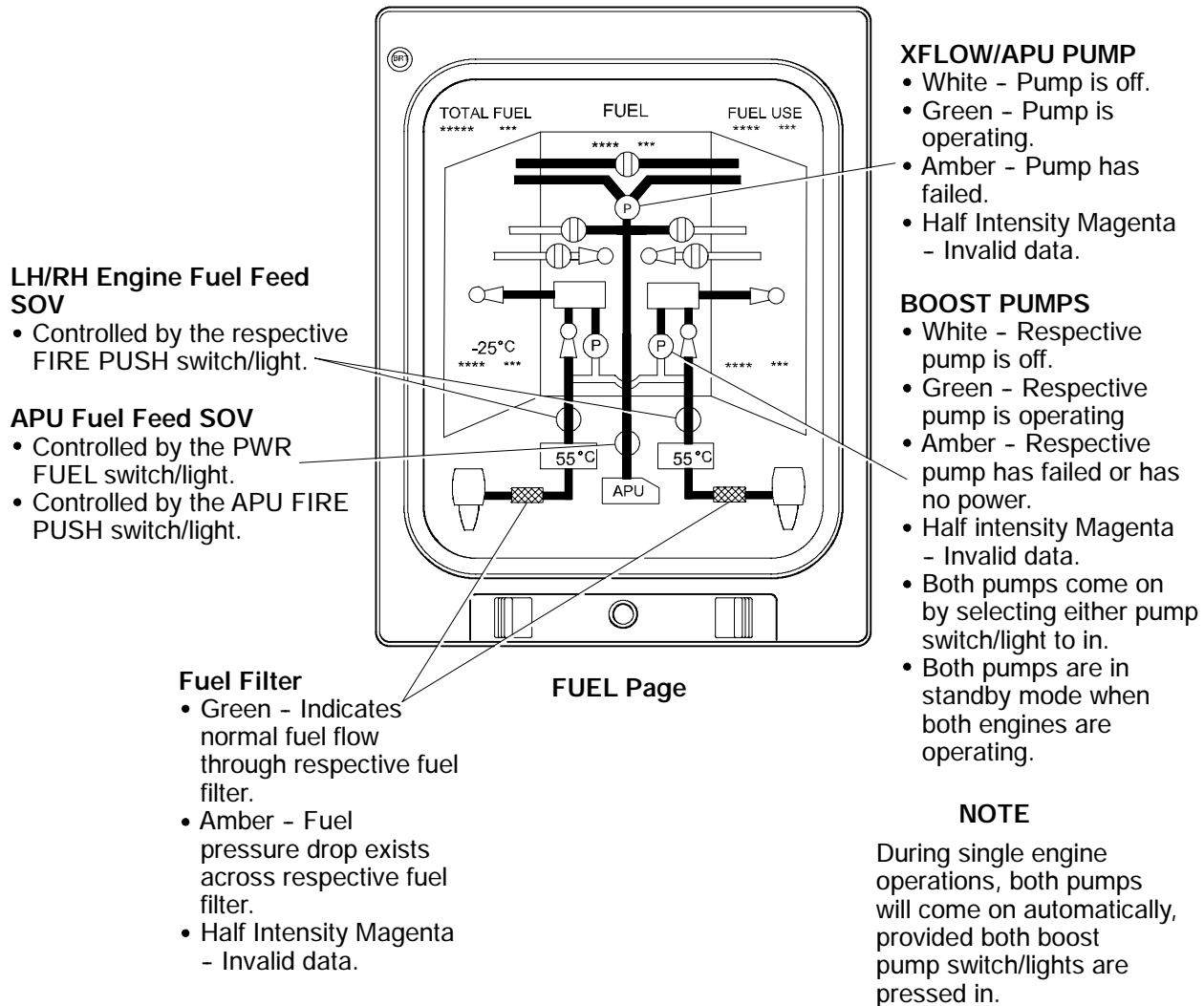

Standby Fuel Feed System – Fuel Synoptic Page Indications <MST>
Figure 13-40-3

A. System Circuit Breakers

SYSTEM	SUB-SYSTEM	CB NAME	BUS BAR	CB PANEL	CB LOCATION	NOTES
Fuel System	Fuel Pumps and Control	L FUEL PUMP	DC BAT	1	M6	
		L FUEL PUMP CONT			M7	
		R FUEL PUMP	DC BUS 2	2	G10	
		R FUEL PUMP CONT			G11	
	Fuel Control	FUEL SOV L ENG	DC EMERGENCY	1	S2	
		FUEL SOV R ENG			S1	
		FUEL SOV APU			S3	



**FUEL SYSTEM
Fuel Distribution**

Vol. 1

13-40-6

REV 56, Jan 31/03

THIS PAGE INTENTIONALLY LEFT BLANK

1. REFUELING AND DEFUELING

The refuel/defuel system is controlled by the Fuel System Computer (FSC) through selection on a refuel/defuel control panel. Pressure refueling and suction defueling of the aircraft are accomplished using a refuel/defuel adapter located in the right wing, leading edge, root fairing.

Gravity refueling is carried out through filler caps installed on the upper wing surface. The fuel quantity can be monitored using magnetic level indicators installed in the tanks. Water drain valves, installed at various low points, permit testing of fuel for contamination and provide the means of draining any accumulated water.

WARNING

The gravity filler caps are located below the maximum pressure refueling level. Never remove the gravity filler caps if the wing tanks are full or if the fuel quantity is unknown.

PRESSURE FUELING
FUEL: JET A, JET A1, JET B,
JP-4, JP-5, JP-8 OR EQUIV.
MAX. FUELING PRESS. 50PSI/345kPa
MAX. DEFUEL PRESS. -8 PSI/-55kPa

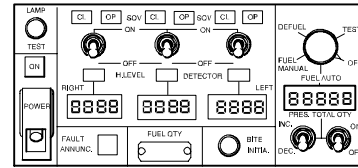

Refuel/Defuel Control Panel <0017>

GRAVITY FILLER CAP
CENTRE TANK
RIGHT SIDE ONLY

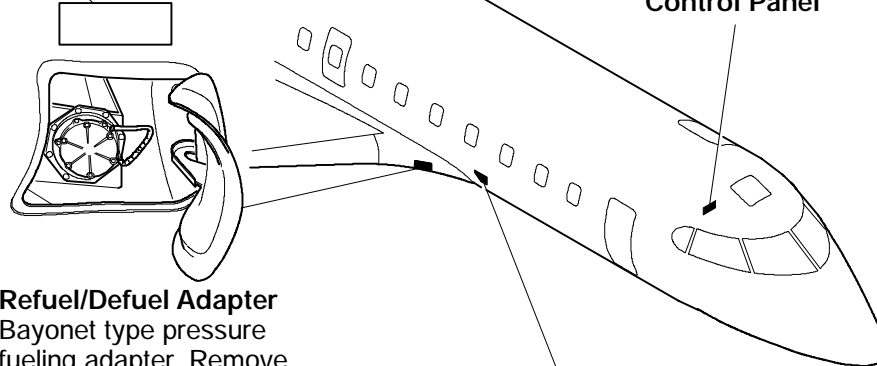

Refuel/Defuel Adapter
Bayonet type pressure
fueling adapter. Remove
protective cap to connect
refuel/defuel hose adapter.

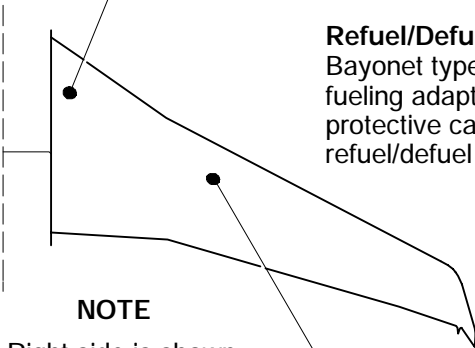

NOTE

Right side is shown.
Left side is opposite.

Gravity Filler Cap (3)
Lift latch and turn
counterclockwise
to unlock.

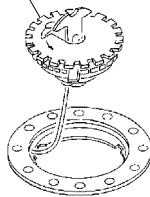

Right Wing Top View

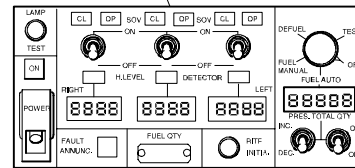

Refuel/Defuel Control Panel

CENTRE TANK
FUEL DRAIN
VALVE LEFT
SIDE ONLY

WATER DRAIN VALVE (16)
Push and rotate water drain
valve core with fuel sampler
to drain fuel into fuel sampler.

TANK FUEL DRAIN
VALVE (3)
Lift latch and turn
counterclockwise to
remove plug.
Insert gravity defueler
adapter to start gravity
defueling.

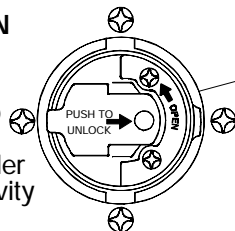

NOTE
Left side is shown.
Right side is opposite.

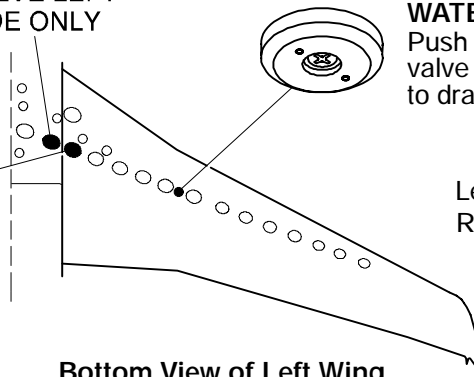

Bottom View of Left Wing

Refuel/Defuel System <MST>
Figure 13-50-1

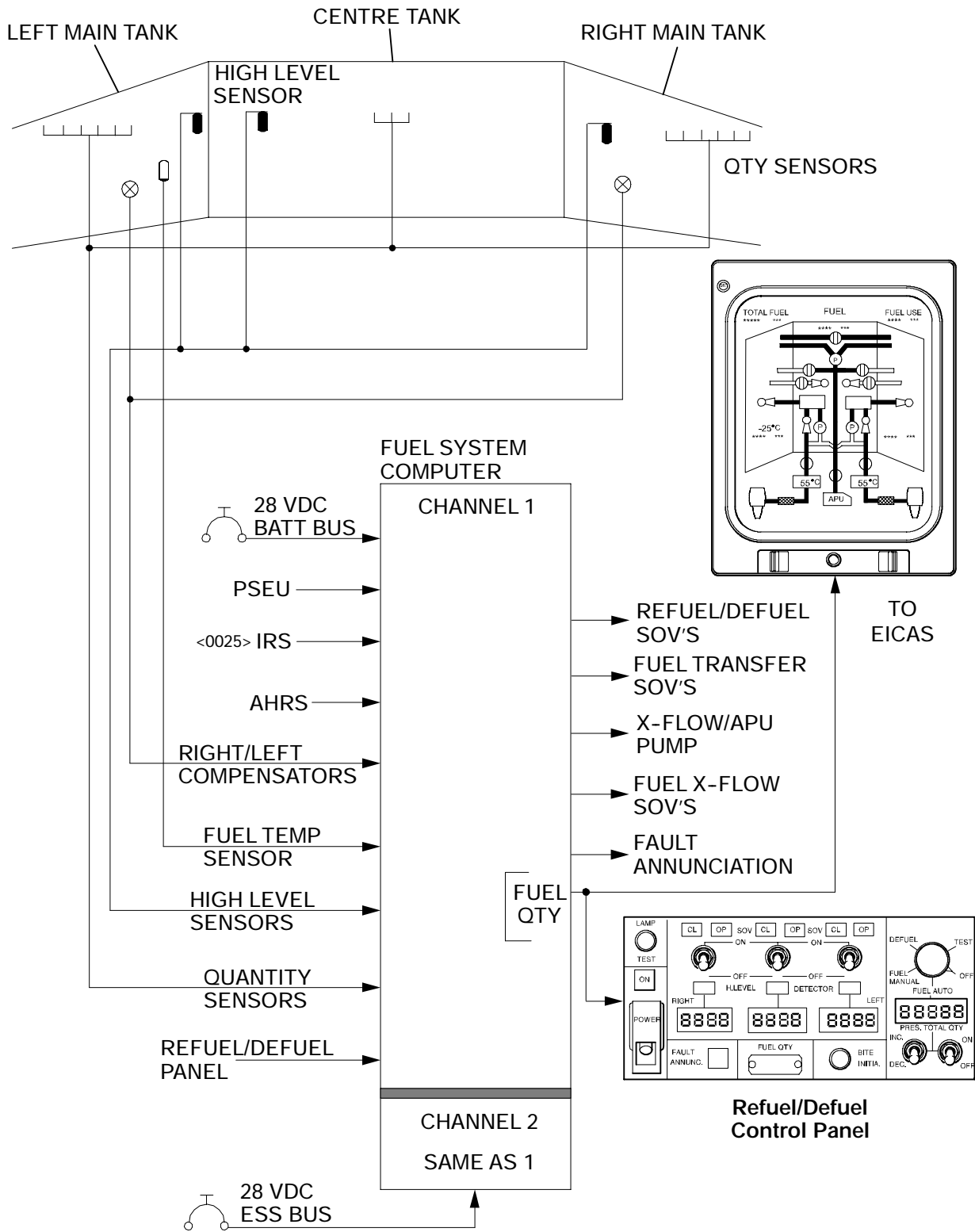

Fuel System Computer <MST>
Figure 13-50-2

A. Control Panel

The aircraft is fitted with a refuel/defuel control panel installed on the right fuselage, just forward of the wing. Fuel quantity indications on the panel are displayed in pounds (Imperial).

The aircraft is fitted with a refuel/defuel control panel installed on the right fuselage, just forward of the wing. Fuel quantity indications on the panel are displayed in kilograms (kg). <0001>

The aircraft is fitted with two identical refuel/defuel control panels. One panel is installed adjacent to the refuel/defuel adapter on the right wing-to-fuselage fairing and the other panel is located in the flight compartment on the bulkhead behind the copilot. Fuel quantity indications on the panels are displayed in pounds (Imperial). When both panels are powered, the flight compartment panel has priority over the external panel. <0017>

The aircraft is fitted with two identical refuel/defuel control panels. One panel is installed adjacent to the refuel/defuel adapter on the right wing-to-fuselage fairing and the other panel is located in the flight compartment on the bulkhead behind the copilot. Fuel quantity indications on the panel are displayed in kilograms (kg). When both panels are powered, the flight compartment panel has priority over the external panel. <0001><0017>

The refueling operation can be initiated in automatic or manual mode. Automatic mode allows the required total aircraft fuel quantity to be preselected. In automatic mode, the fuel system computer (FSC) controls the distribution of the fuel by filling the wing tanks before allowing any fuel to be loaded into the center tank. High level detectors located at the top of each tank prevent fuel tank overfilling during refueling operations by closing the refuel shut-off valves.

Refueling of individual tanks is possible in manual mode by manually opening and closing the refuel shut-off valves from the control panel.

The defuel mode is similar to the manual mode except that defueling is selected.

The test mode checks that the FSC, high level detectors and refuel/defuel shutoff valves are operating properly.

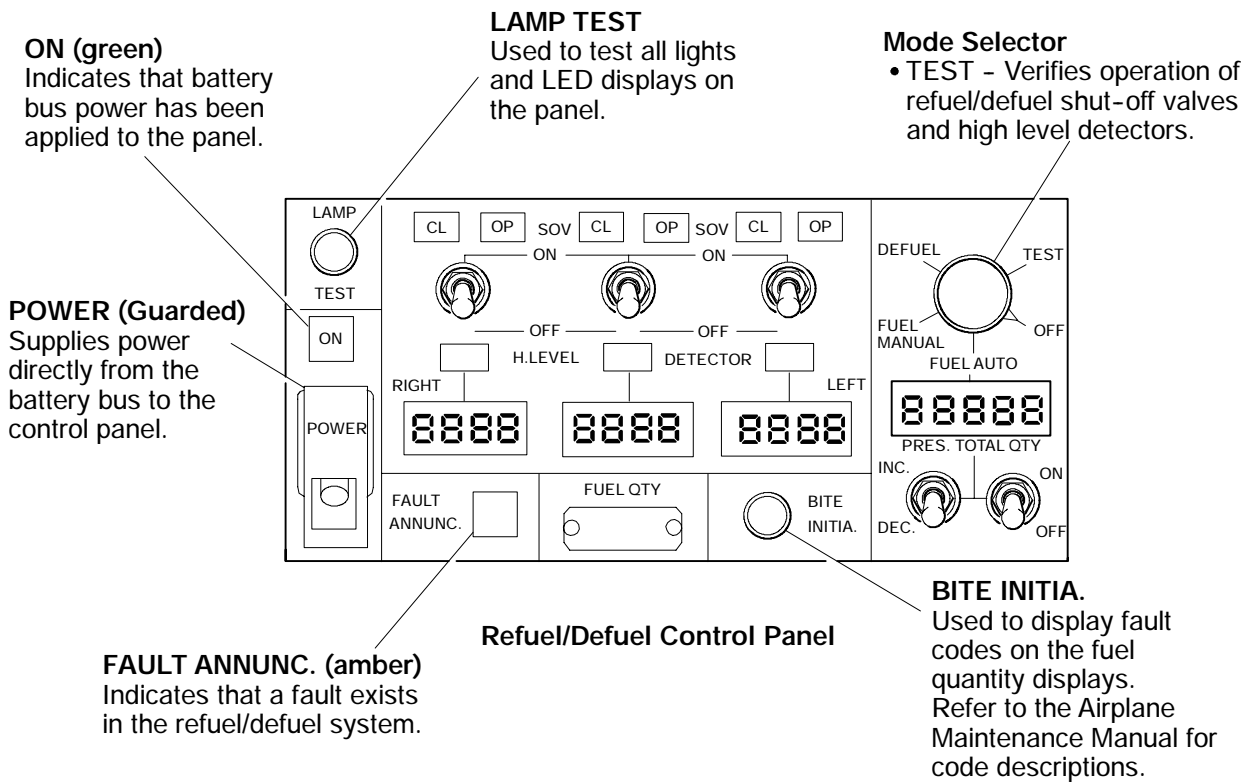

Refuel/Defuel Control Panel
Figure 13-50-3 Sheet 1

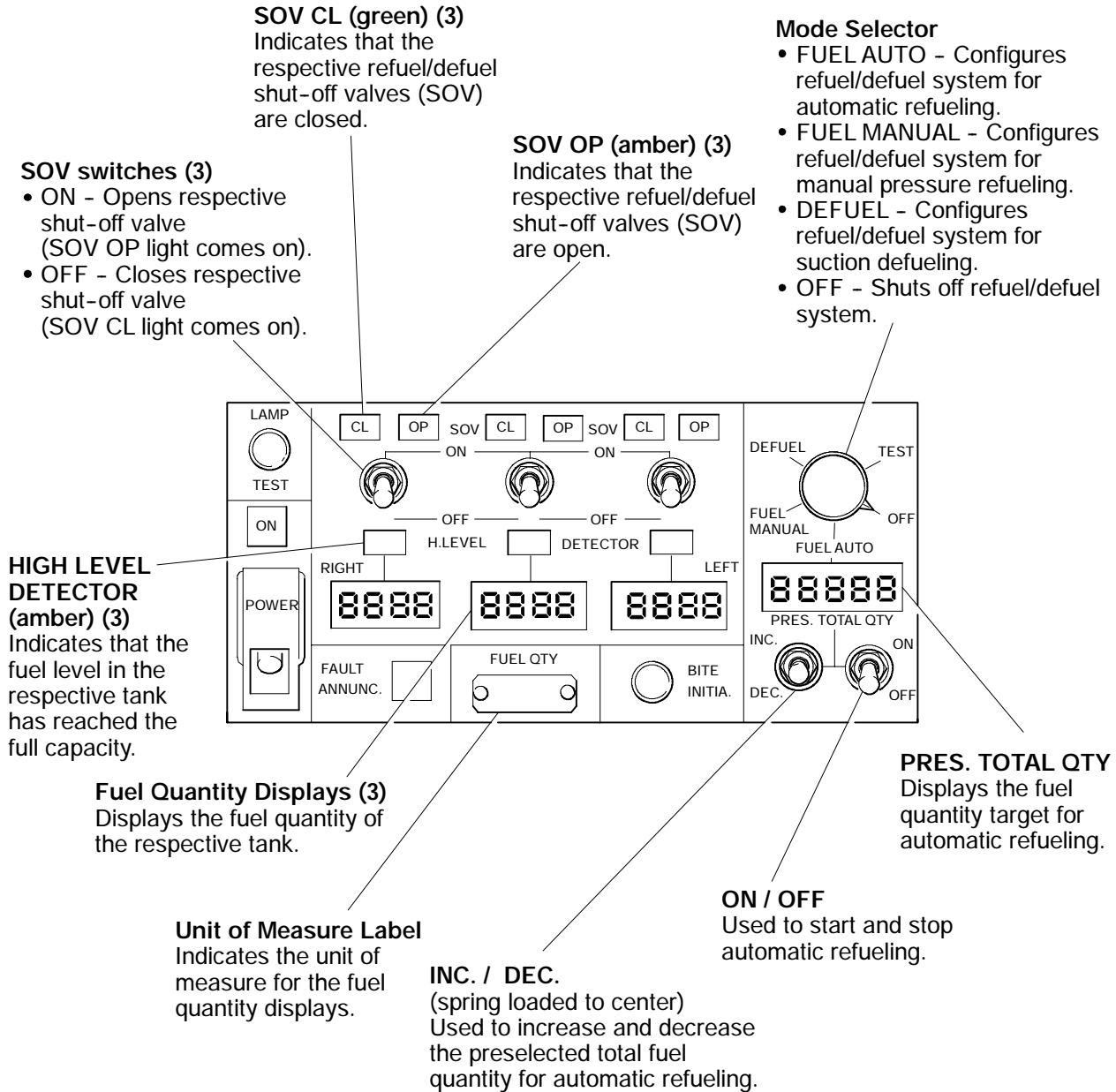

Refuel/Defuel Control Panel
Figure 13-50-3 Sheet 2



FUEL SYSTEM
Refueling and Defueling

Vol. 1

13-50-7

REV 56, Jan 31/03

B. System Circuit Breakers

SYSTEM	SUB-SYSTEM	CB NAME	BUS BAR	CB PANEL	CB LOCATION	NOTES
Fuel System	Refuel and Defuel Panel	EMERG REFL	APU BAT DIR	5	B15	
		FUEL/DEFUEL			B14	



**FUEL SYSTEM
Refueling and Defueling**

Vol. 1

13-50-8

REV 56, Jan 31/03

THIS PAGE INTENTIONALLY LEFT BLANK

	FUEL SYSTEM Fuel Quantity Gauging		Vol. 1	13-60-1
				REV 56, Jan 31/03

1. FUEL QUANTITY GAUGING SYSTEM

The fuel system computer (FSC) monitors information from fuel probes in each tank to calculate the fuel quantity.

Fuel quantity is measured using fuel probes, which provide signals directly proportional to fuel level to the FSC. There are 6 probes in each wing tank and 3 in the centre tank. A compensator probe in each wing tank supplies data to the FSC to compute fuel density corrections.

Fuel quantity gauging is calibrated for both ground and flight operations by the the computer which receives weight-on-wheel signals from the proximity sensing electronic unit (PSEU). In flight, the computer takes into account the effects of wing deflection and aircraft attitude on the fuel quantity measurement.

Corrected individual tank quantities, total fuel quantity, fuel used quantity and fuel temperature are displayed on the Engine Indication and Crew Alerting System (EICAS) as well as any fault detected in the fuel quantity gauging computer.

The FUEL USED indication on the FUEL synoptic page can be reset to zero through the EICAS menu page.

The FUEL USED indication on the FUEL synoptic page can be reset to zero through the FMS, ACT PERF INIT page. If the FMS is failed or not available, the FUEL USED indication can be reset to zero through the EICAS menu page.<0039>

The temperature of the fuel is continuously monitored by a fuel temperature sensor installed in the left wing tank. The sensor supplies a fuel temperature signal to the EICAS for display on the FUEL synoptic page.

	Flight Crew Operating Manual CSP A-013	MASTER
--	---	---------------

FUEL FLOW READOUT
Indicates fuel flow, in pounds per hour (PPH) or kilograms per hour (KPH) <0001>, to the respective engine. Amber dashes will be displayed if input value exceeds 5,000 lb/h (2,270 kg/h) <0001> or input value is invalid.

FUEL QUANTITY READOUT (centre tank)
Indicates fuel quantity in the centre tank.

- Green - Fuel quantity is > 10 lb (5 kg) <0001>.
- White - Fuel quantity is < 10 lb (5 kg) <0001>.

FUEL CH 1, 2 FAIL status (white)
Comes on to indicate that the respective channel of the fuel system computer has failed.

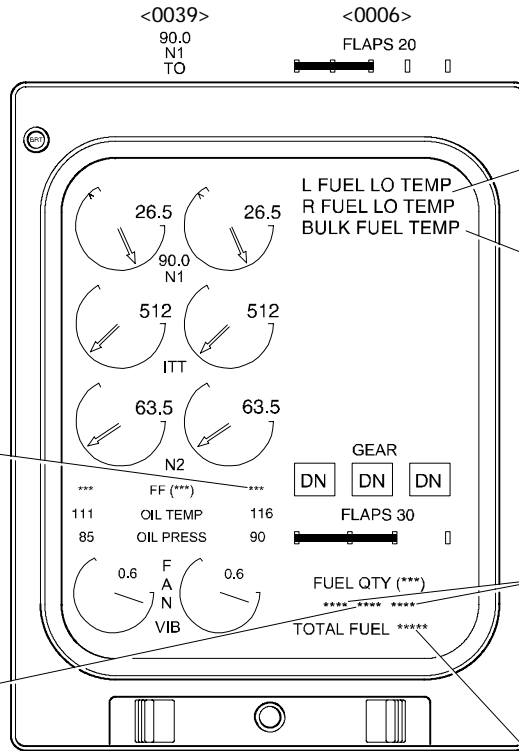

Primary Page

L, R FUEL LO TEMP
caution (amber)
Comes on to indicate that fuel feed temperature on the respective side is < 5 °C with respective engine running.

BULK FUEL TEMP
Caution (amber)
Comes on to indicate that the temperature of fuel in tanks is less than -40 °C.

TOTAL FUEL READOUT
Indicates the total fuel quantity, in pounds (LBS), or in kilograms (KGS) <0001>, of all tanks.

- Green - Total fuel quantity is > 900 lb (408 kg) <0001>.
- Amber - Total fuel quantity is < 900 lb (408 kg) <0001>.
- Half-Intensity Magenta - Low fuel detection invalid.

FUEL QUANTITY READOUT (left and right tank)
Indicates fuel quantity of the respective tank, in pounds (LBS), or kilograms (KGS) <0001>.

- Green - Left and right tanks are balanced and total fuel quantity is > 900 lb (408 kg) <0001>.
- Amber - A fuel quantity imbalance > 400 lb (180 kg) <0001> exists between the right and left tanks, or the total fuel quantity is < 900 lb (408 kg) <0001>.

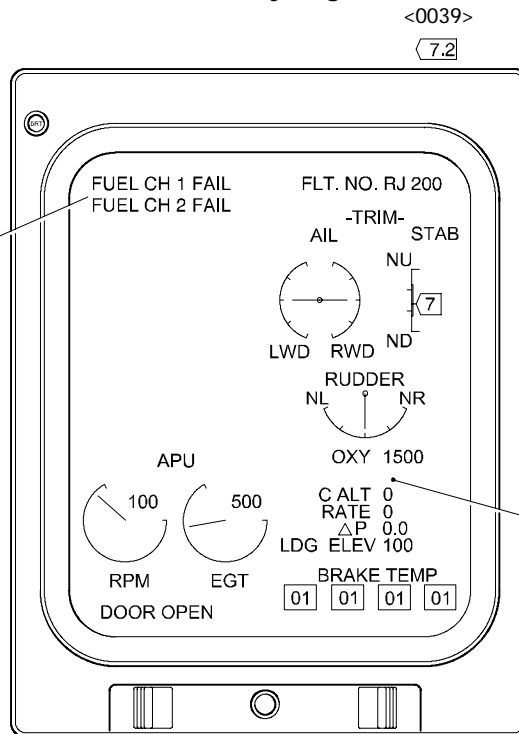

Status Page

<0039>
C TEMP 23°C

Refuel/Defuel – EICAS Messages <MST>
Figure 13-60-1

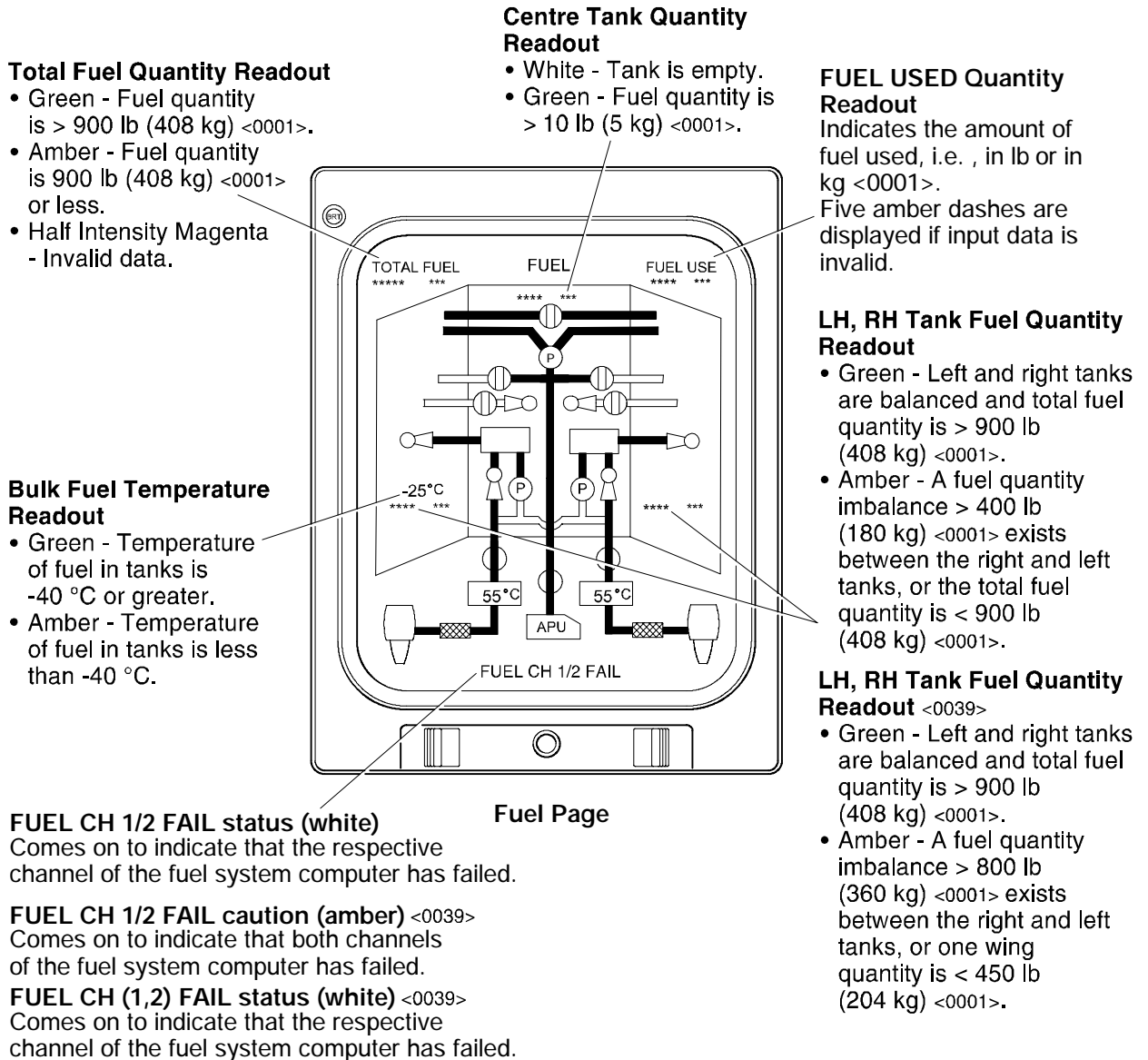

Refuel/Defuel System – Fuel Synoptic Page Indications <MST>
Figure 13-60-2

FUEL USED RESET

- Accessed through UP/DN keys on EICAS control panel.
- Cursor will go to ACCEPT line and prompt message will appear.
- SEL switch on EICAS control panel is used to confirm selection.

NOTE

1. CANCEL line used to cancel change (not reset fuel used).
2. Fuel synoptic page will display reset value.
3. Fuel used reset through Menu page does not update FMS.

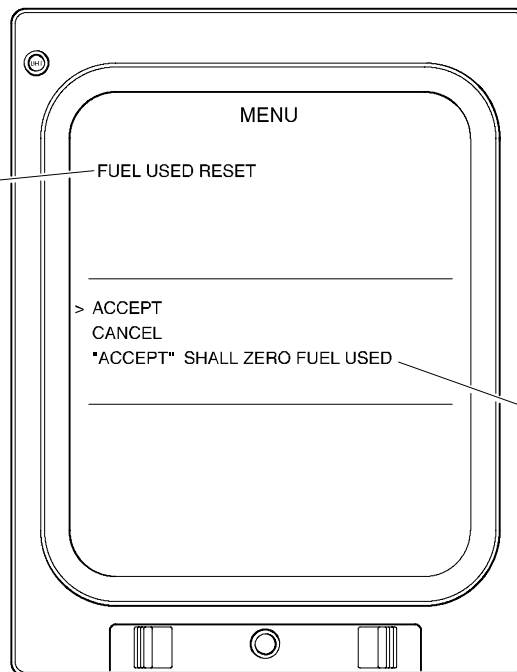

Data Entry Message Comes on when the cursor goes to the ACCEPT line after selection of the FUEL USED RESET line.

Menu Page

Fuel System – Menu Page
Figure 13-60-3

	FUEL SYSTEM Fuel Quantity Gauging	Vol. 1	13-60-5
		REV 56, Jan 31/03	

A. Magnetic Level Indicators

Two magnetic level indicators (MLI's) are installed in each wing tank and one is installed in the center tank. The MLIs are located under the wing and are used to manually check the fuel level in each tank.

To make sure that the MLI readings are accurate, the aircraft must be level. Pitch and roll inclinometers are provided on the right flight compartment bulkhead to verify that the airplane is level. After the MLI readings are taken, they are then converted to units of fuel quantity using tabulated charts contained in FCOM Volume 2, Supplementary Procedures.

	Flight Crew Operating Manual CSP A-013	MASTER
--	---	---------------

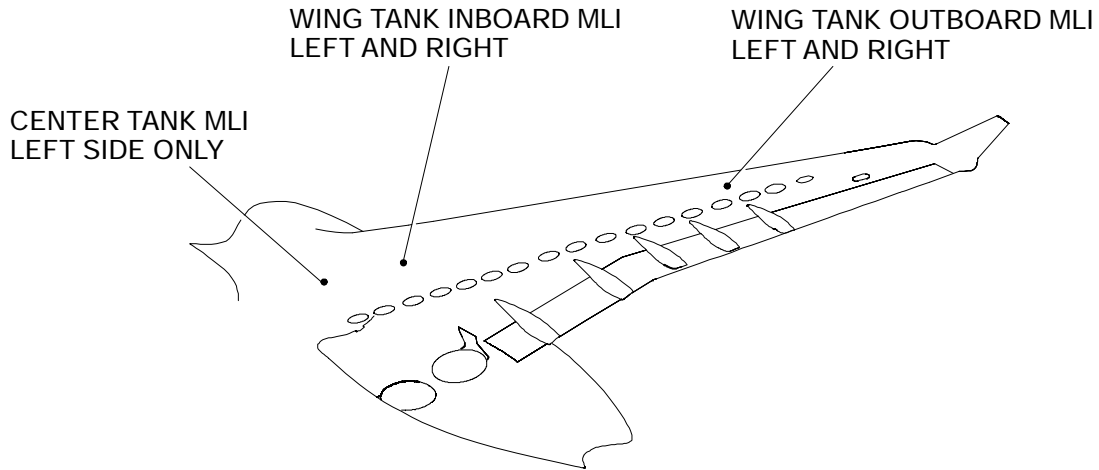

Magnetic Level Indicators (MLI) (5)
Push and rotate MLI core with a screwdriver to the unlocked position to deploy.

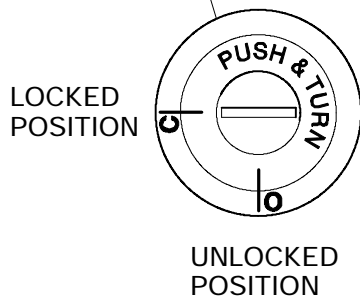

VIEW LOOKING UP WITH THE MLI LOCKED IN THE CLOSED POSITION

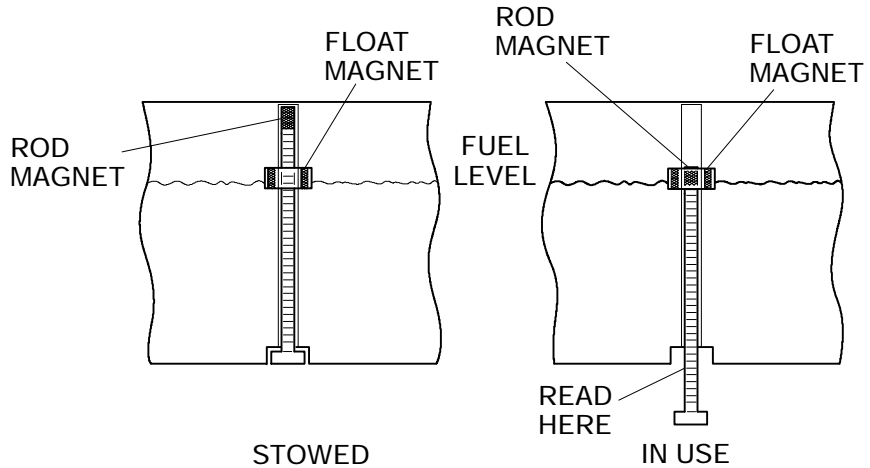

NOTE

For MLI readings conversion, refer to FCOM Vol. 2, SUPPLEMENTARY PROCEDURES, FUEL SYSTEM.

Magnetic Level Indicators
Figure 13-60-4

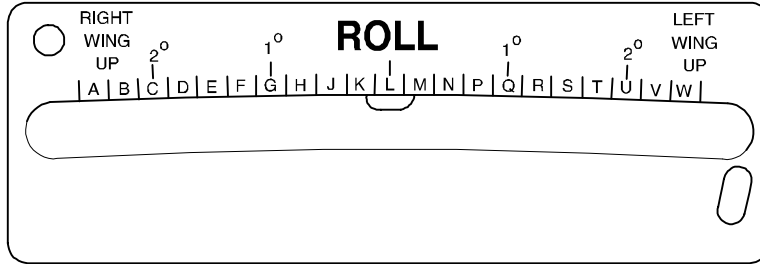

ROLL INCLINOMETER

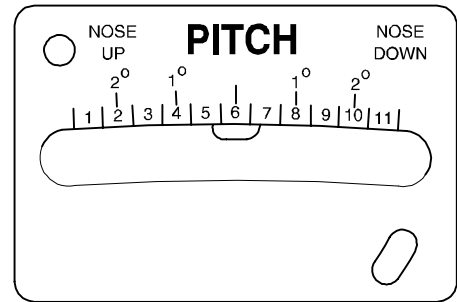

PITCH INCLINOMETER

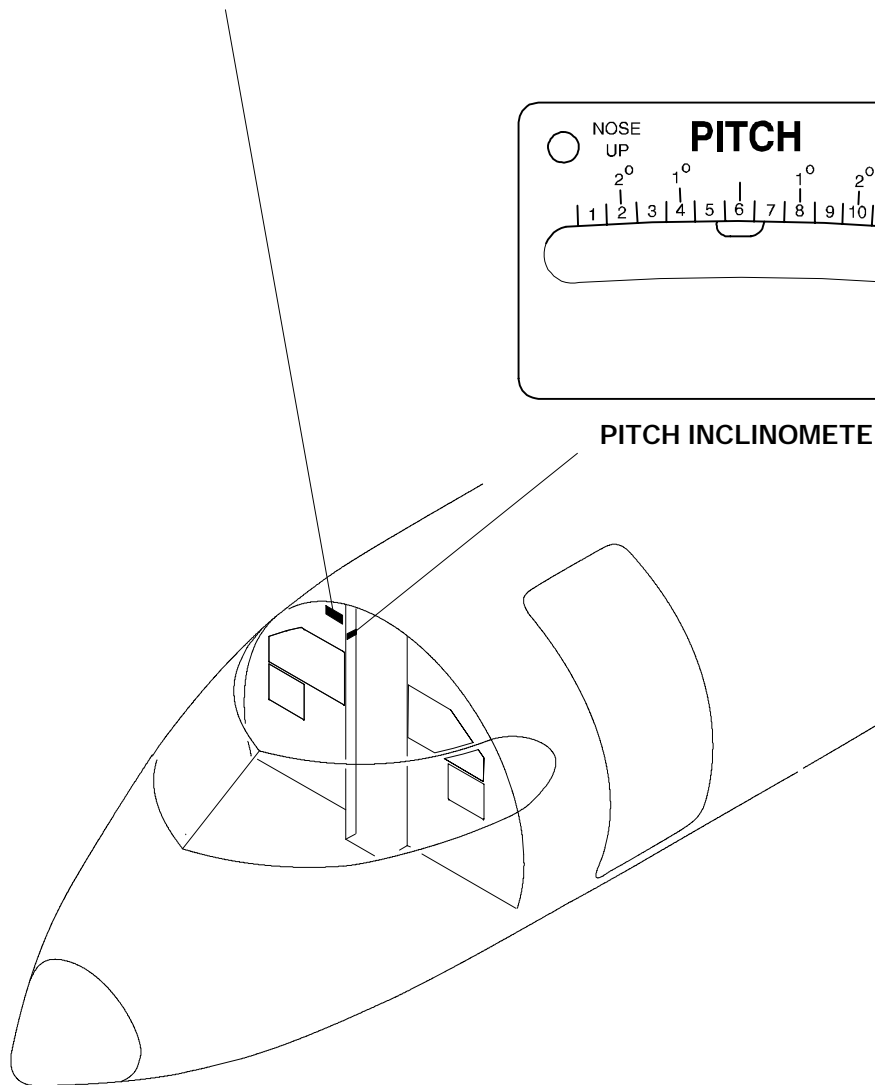

Pitch and Roll Inclinometers
Figure 13-60-5



FUEL SYSTEM
Fuel Quantity Gauging

Vol. 1 13-60-8

REV 56, Jan 31/03

B. System Circuit Breakers

SYSTEM	SUB-SYSTEM	CB NAME	BUS BAR	CB PANEL	CB LOCATION	NOTES
Fuel System	Fuel Control	FUEL SYST CONT	DC BAT	4	B10	
		FUEL SYST CONT	DC ESS	1	M12	