

Table of Contents

Introduction	15-1
Landing Gear	15-2
Description	15-2
Components	15-2
Main Landing Gear (MLG)	15-2
Nose Landing Gear (NLG)	15-4
Operation	15-6
Gear Retraction	15-6
Gear Extension	15-8
Alternate Landing Gear Extension	15-9
Landing Gear Horn	15-11
Proximity Sensing Electronic Unit (PSEU)	15-12
Description	15-12
Operation	15-12
Main Wheel Bins and Overheat Detection	15-13
Description	15-13
Components and Operation	15-13
Wheel Bins	15-13
Main Landing Gear Overheat Detection	15-13
MLG Bay Overheat Test	15-13
Nosewheel Steering System	15-14
Description	15-14
Components and Operation	15-14
Electronic Control Unit (ECU)	15-14
Wheels and Brakes	15-16
Description	15-16
Components and Operation	15-16
Parking Brake	15-18
Anti-Skid System	15-19
Controls and Indicators	15-19
EICAS Messages	15-22

Page Intentionally Left Blank

List of Figures

Graphic Title	Figure
Landing Gear	15-1
Main Landing Gear	15-2
Nose Gear.....	15-3
Normal Gear Extension.....	15-4
Alternate Gear Extension.....	15-5
MLG BAY OVHT TEST Switches	15-6
Steering Tiller.....	15-7
Brakes and Lower Main Gear Structure.....	15-8
Hydraulic Synoptic Page (Inboard and Outboard Brake Pressure)	15-9
Parking Brake Handle	15-10
Landing Gear Panel.....	15-11
Landing Gear Manual Release	15-12
Landing Gear EICAS Displays.....	15-13

Page Intentionally Left Blank

Introduction

The landing gear for the Challenger 604 is arranged in a standard retractable tricycle configuration. Associated subsystems include:

- proximity sensing system
- nose gear doors
- nosewheel steering
- wheel brakes with anti-skid
- main landing gear overhear detection

Hydraulic system 3 powers landing gear extension and retraction, nosewheel steering, and brakes.

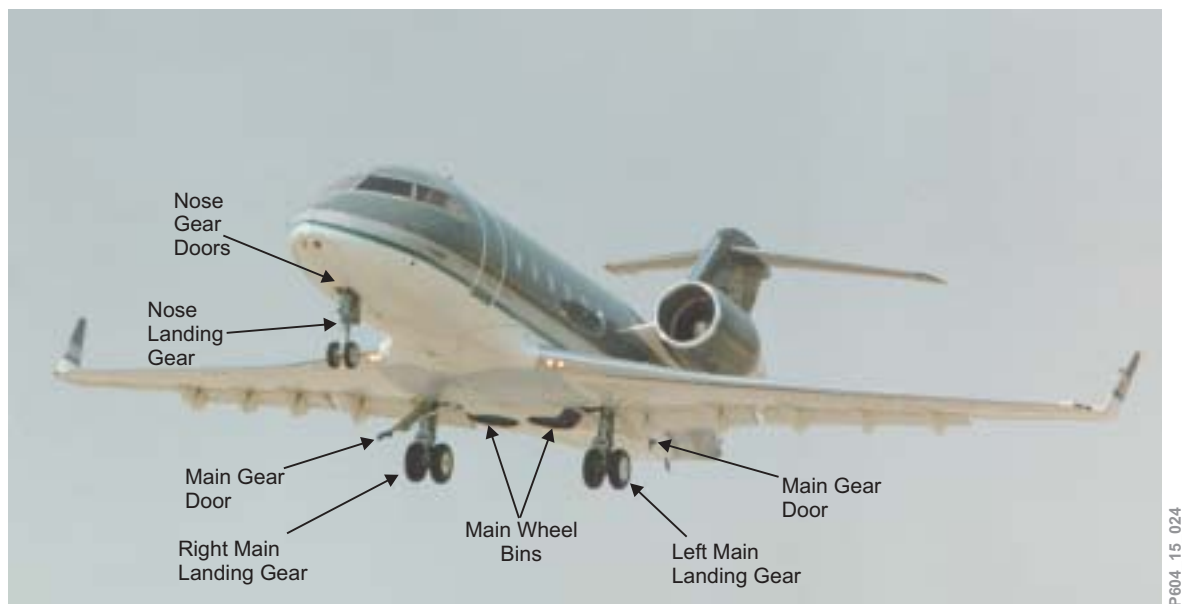

Landing Gear

Figure 15-1

Landing Gear

Description

The main landing gear consists of two trailing link-type assemblies. The main landing gear retracts inward toward the centerline of the fuselage. The main landing gear is hydraulically actuated by hydraulic system 3 and electrically controlled by the proximity sensing electronic unit (PSEU).

The nose gear is a forward retracting assembly. The nose gear and forward nose gear doors are hydraulically actuated by hydraulic system 3 and electrically controlled by the PSEU.

A manual landing gear extension feature is provided.

Components

Main Landing Gear (MLG)

Each main gear assembly consists of:

- Main beam
- Nitrogen-charged/oil-filled shock strut
- Trailing link
- MLG actuator
- Internal downlock mechanism
- Axle, brake, and wheel assemblies
- Uplock pins
- MLG doors
- Weight-On-Wheels proximity sensors

Main Wheel Bins

Each main gear assembly retracts inward into wheel bins recessed in the main landing gear bay. Each wheel bin contains a single-loop overhear detection wire to provide an EICAS warning should a wheel overheat occur.

MLG Uplocks and Downlocks

The MLG is held in the up-and-locked position by mechanical uplocks. With the gear extended, internal locking mechanisms within the MLG actuators lock the gear in the down position. On the ground, MLG ground locking pins can be inserted into the MLG actuator.

MLG Doors

MLG doors mechanically attached to each of the MLG struts allow for partial enclosure of the gear when retracted. In the retracted position, brush seals on the door and wheel bins provide an aerodynamic seal between the tires and surrounding aircraft structures.

MLG Weight-On-Wheels (WOW) Sensors

Two WOW proximity sensors are incorporated in each main gear assembly. They are used to prevent landing gear retraction on the ground and they provide “ground” or “air” status for other aircraft systems via the PSEU.

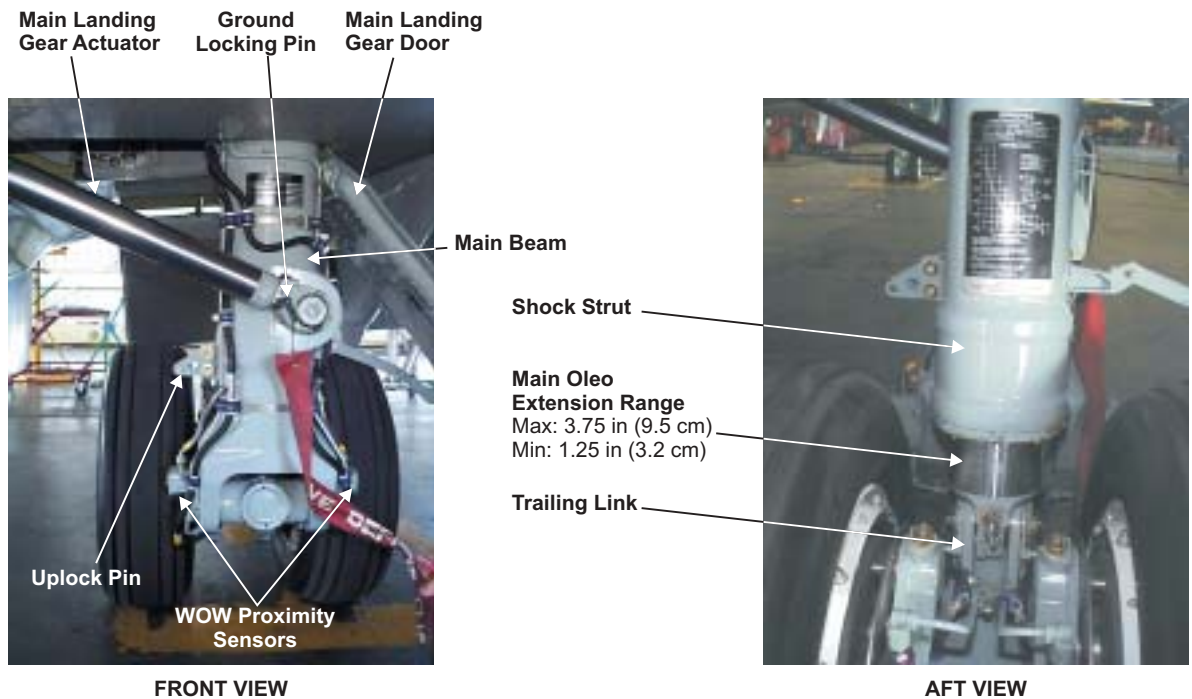

Main Landing Gear

Figure 15-2

Nose Landing Gear (NLG)

The nose gear consists of:

- Nose gear shock strut (Nitrogen-charged/oil-filled)
- Nose gear actuator
- Drag brace with downlock
- Steering actuator
- Axle and wheel assembly
- Uplock pin
- NLG doors
- Weight-On-Wheels proximity sensors

NLG Uplocks and Downlocks

The nose gear is held in the up-and-locked position by a mechanical uplock. With the gear extended, an overcenter locking mechanism in the drag brace holds the gear in the down-and-locked position. On the ground, a NLG ground locking pin can be inserted in the drag brace mechanism.

Nose Doors

With the NLG up and locked, the nose gear compartment is fully enclosed by nose doors. When the gear is up, the aft nose door, mechanically attached to the landing gear assembly, provides partial enclosure of the gear. Left and right forward nose doors are electrically controlled by the PSEU and hydraulically actuated by hydraulic system 3.

When the landing gear is selected down, the forward doors open to allow passage of the gear assembly. When the gear is down and locked, the forward doors close to minimize drag.

When the landing gear lever is selected up, the forward doors open to allow passage of the gear assembly and then close after the gear is mechanically locked in the up position.

The nose landing gear forward doors' actuation, sequencing, and position sensing are controlled and continuously monitored by the PSEU. Any nose door faults or detection of a door position deviation is annunciated by the NOSE DOOR OPEN warning EICAS message and "NOSE DOOR" aural warning.

A maintenance access switch is installed on the external service panel to open and close the nose doors for ground servicing if hydraulic system 3 pressure is available.

WARNING

PRIOR TO ACTIVATING HYDRAULIC SYSTEM 3, ENSURE THAT THE NOSE GEAR COMPARTMENT IS CLEAR OF PERSONNEL AND / OR SERVICING EQUIPMENT.

NLG WOW Sensors

Two WOW proximity sensors are incorporated in the nose gear assembly. They prevent landing gear retraction when the aircraft is on the ground, and they provide “ground” or “air” status for other aircraft systems via the PSEU.

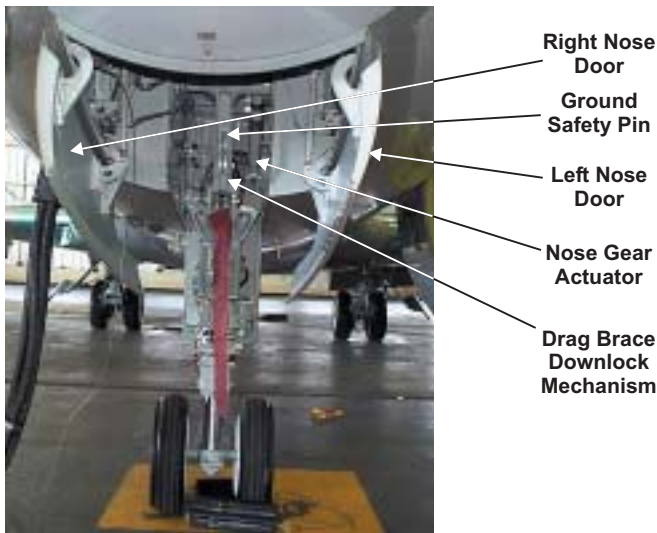
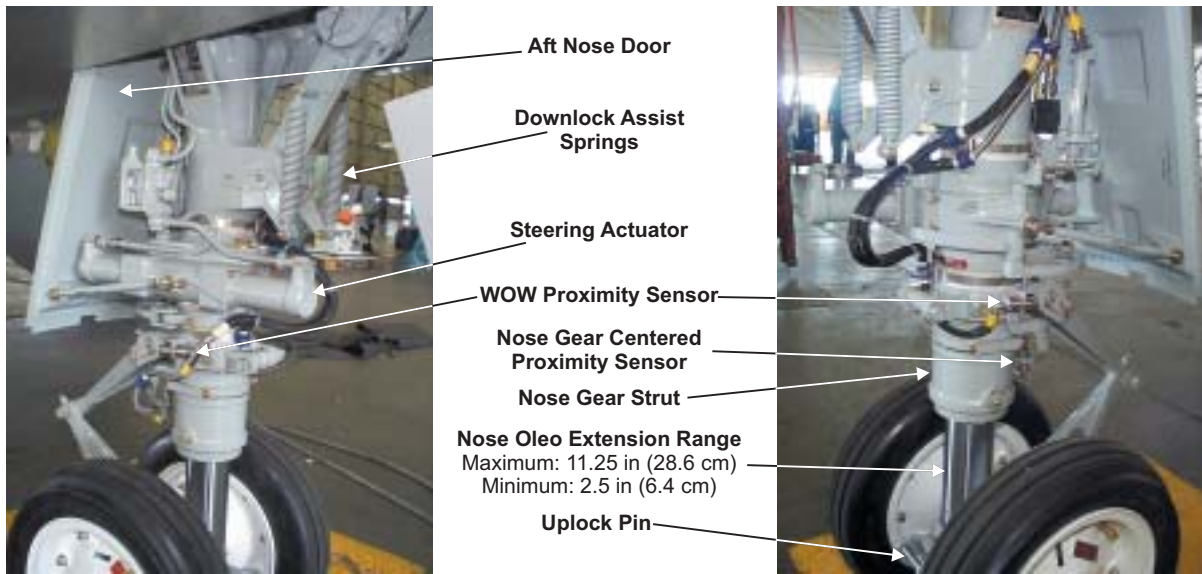

NOSE GEAR DOORS



NOSE LANDING GEAR DOOR SWITCH

P604_15_026

Nose Gear

Figure 15-3

Operation

Normal retraction or extension of the landing gear is initiated by selecting the LDG GEAR lever UP or DN. The retraction or extension signal is sent to the PSEU, which monitors landing gear proximity sensor and weight-on-wheel (WOW) inputs. If the correct proximity sensor and WOW parameters are met, the PSEU sequentially energizes the appropriate selector valves to retract or extend the landing gear using hydraulic system 3 pressure.

Gear Retraction

During gear retraction, the nose landing gear (NLG) retracts forward against the airflow and the main landing gear (MLG) retract inward. Maximum retraction speed is 197 KIAS (0.6 M).

During landing gear retraction (aircraft in “air” mode / no WOW signal), the PSEU commands and monitors the following events:

- landing gear lever solenoid lock is released to allow the landing gear lever to be selected up
- NLG door selector valve is energized to open the forward nose landing gear doors
- NLG and MLG selector valves are energized to direct hydraulic fluid to release the respective downlocks and retract the NLG and MLG. Hydraulic pressure from the nose gear up line is directed to the brake control valves to stop main wheel rotation (in-flight braking)
- when the gear is fully retracted, uplocks for the NLG and MLG are mechanically engaged to secure the landing gear in the retracted position
- NLG door selector valve is energized to close the forward NLG doors
- on completion of the retract sequence, NLG, NLG door and MLG selector valves are de-energized and hydraulic pressure is removed. The NLG, NLG door and MLG are held by their respective close / uplock mechanisms

Downlock Release

The landing gear lever is equipped with a solenoid lock, which prevents UP selection of the landing gear lever with the airplane on the ground. After takeoff, if the solenoid lock or a PSEU malfunction occurs, a downlock release button (DN LCK REL) on the landing gear control panel can be used. Pressing the DN LCK REL button mechanically withdraws the solenoid lock permitting UP selection of the landing gear lever.

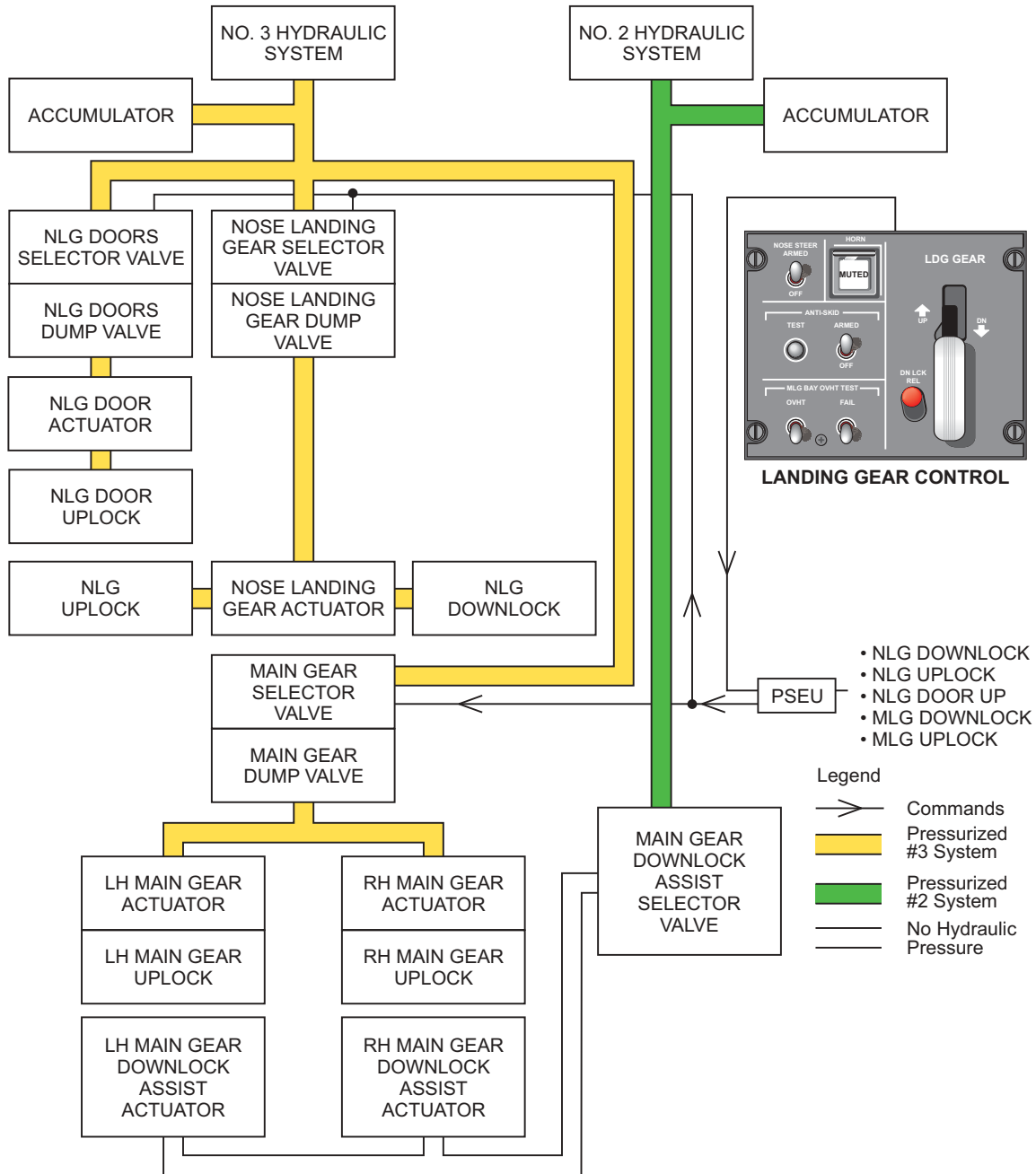

PG04_15_009

Normal Gear Extension

Figure 15-4

Gear Extension

During gear extension, the NLG extends rearward and the MLG extend outward. Maximum extension speed is 197 KIAS (0.6 M).

When the LDG GEAR handle is selected to the DN position, the PSEU commands and monitors the following events:

- NLG door selector valve is energized to open the forward NLG doors
- NLG and MLG selector valves are energized to direct hydraulic fluid to release the respective uplocks and extend the landing gear
- NLG and MLG downlocks are mechanically engaged to secure the landing gear in the extended position
- NLG door selector valve is energized to close the forward NLG doors
- the hydraulic selector valves remain energized to provide full-time hydraulic pressure on the NLG and MLG actuators and to hold the NLG door closed

NOTE

The maximum airspeed at which the airplane may be flown with the landing gear extended and locked is 250 KIAS (0.7 M).

NOTE

If the landing gear position does not match the LDG GEAR handle position within 28 seconds, the amber gear in transition indication is replaced by the red gear not safe indication, accompanied by the "GEAR DISAGREE" warning EICAS message and aural warning.

Alternate Landing Gear Extension

Should a failure occur with the landing gear control circuitry or hydraulic system 3, landing gear extension is still possible by pulling the red landing gear manual release handle.

Pulling the handle mechanically releases the nose gear forward door uplock and the three landing gear uplocks. In addition, the handle operates dump valves that remove hydraulic pressure, allowing the gear to free-fall.

The nose doors open as the landing gear free-falls under its own weight. The nose gear extends rearward and is assisted to the down-and-locked position by two downlock assist springs (which lock the drag brace) and by the airflow pushing against the gear. The nose doors will remain open.

The MLG free-fall to the extended position. The main landing gear are assisted to the down-and-locked position by the MLG downlock assist actuators which are powered by hydraulic system 2. The MLG downlock assist actuators force the MLG actuators to full extension, which engages the internal downlock mechanisms.

A ball-detent retains the landing gear manual release handle in the extended position. To reset the handle, the button in the center of the handle must be depressed and the handle lowered to the stowed position.

NOTE

To ensure priority to the primary flight controls, a spring-loaded-closed priority valve cuts off hydraulic system 3 pressure to the landing gear selector valves if system 3 pressure drops below 2100 psi. Alternate landing gear extension will be required in this case.

NOTE

When normal hydraulic system 3 pressure is available, stowing the manual gear release handle returns the landing gear selector valves to normal operation.

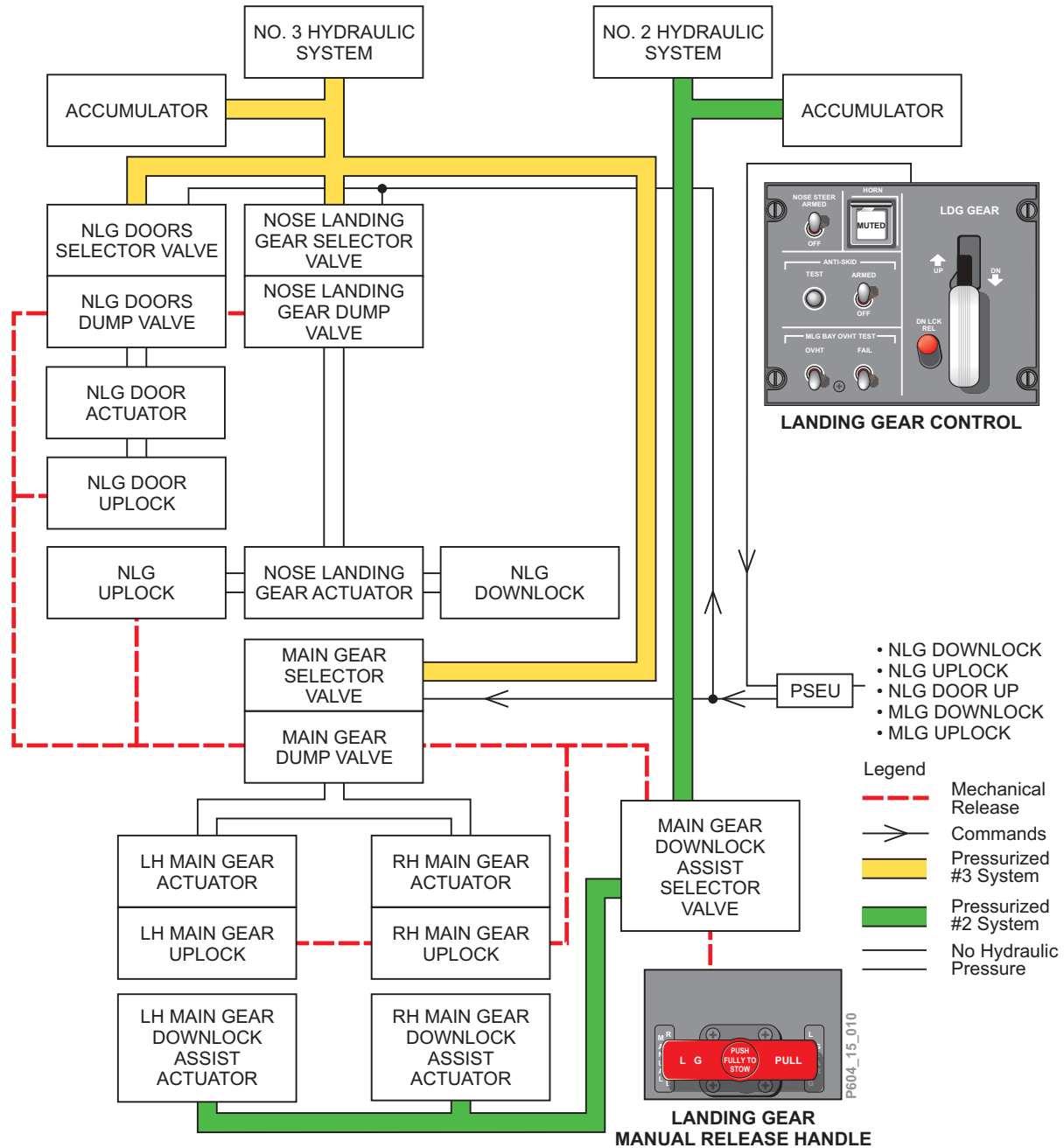

Alternate Gear Extension

Figure 15-5

Landing Gear Horn

The landing gear horn will sound when the aircraft is weight off wheels for more than two minutes, any gear is not down and locked, and one of the following conditions is fulfilled:

RADAR ALTITUDE	RATE OF DESCENT	AIRSPEED	FLAPS	THROTTLES	HORN	CAPABLE OF MUTING
> 1000 ft	Any	Any	Any	Any position	Off	N/A
Radalt inop	Any	< 185 kts	0	Both idle	On	No
Radalt inop	Any	< 185 kts	0	One idle	On	Yes
Radalt inop	Any	< 163 kts	< 30	One idle	On	Yes
Radalt inop	Any	< 163 kts	Any	Both idle	On	No
Radalt inop	Any	< 163 kts	> 30	Any position	On	No
< 1000 ft	VSI inop	Any	Any	Any position	On	No
< 1000 ft	> 400 fpm	Any	Any	Any position	On	No
< 500 ft	Any	Any	Any	Both idle	On	No
< 500 ft	Any	Any	> 30	Any position	On	No

Gear Horn Logic with “Precision Plus”

Table 15-1

AIRSPEED	FLAPS	THROTTLES	HORN	CAPABLE OF MUTING
> 185 kts	0	Both idle	Off	N/A
< 185 kts	0	Both advanced	Off	N/A
< 185 kts	0	One idle	On	Yes
< 185 kts	0	Both idle	On	No
> 163 kts	> 0	Both idle	Off	N/A
< 163 kts	< 30	Both advanced	Off	N/A
< 163 kts	< 30	One idle	On	Yes
< 163 kts	< 30	Both idle	On	No
< 163 kts	> 30	Any position	On	No

Gear Horn Logic without “Precision Plus”

Table 15-2

Proximity Sensing Electronic Unit (PSEU)

Description

The proximity sensing electronic unit (PSEU) receives data from various proximity sensors, microswitches, and cockpit controls and switches. The PSEU processes this data to control the landing gear extension and retraction sequences, and to provide aircraft configuration information to various systems for flight and ground operations.

Operation

Proximity sensors measure the physical relationship between two aircraft components (sensor and target). If the components are close, the sensors or microswitches provide a “near” signal. If the components are separated, a “far” signal is generated. The PSEU processes this information to command landing gear and other aircraft systems’ operation.

In the case of the landing gear, the PSEU monitors the position of the landing gear, nose doors, uplocks, downlocks and Weight On Wheels (WOW). It also electrically controls the hydraulic selector valves during normal landing gear extension and retraction. After takeoff, the PSEU disables the anti-skid and nosewheel steering systems. At touchdown it rearms the systems for use during the landing roll and taxi.

There are two WOW proximity sensors installed on each landing gear assembly, for a total of six WOW sensors. Various aircraft systems require “ground” or “air” mode information for operation. The PSEU determines “ground” mode and “air” mode as follows:

PSEU MODE DETERMINATION	REQUIRED CONDITIONS
Ground	- Any three of the four main gear proximity sensors indicate Weight On Wheels
Air	- If “ground” mode conditions are not satisfied, the PSEU is in “air” mode

PSEU Mode Determination Table

Table 15-3

Main Wheel Bins and Overheat Detection

Description

Each main gear assembly retracts inward into wheel bins that are recessed in the main landing gear bay.

Components and Operation

Wheel Bins

The wheel bins isolate the wheels from the main landing gear bays and prevent tire-thrown debris from damaging the equipment located within the MLG bay. The bins can be removed to allow maintenance personnel access to the MLG bay.

Main Landing Gear Overheat Detection

An overheat detection unit and heat-sensing loop continuously monitor each wheel bin for overheat conditions. If an overheat condition exists, the MLG BAY OVHT warning EICAS message will be displayed and the aural “GEAR BAY OVERHEAT” will sound.

If a failure is detected (shorted heat-sensing loop), the MLG BAY OVHT FAIL caution EICAS message will be displayed. For additional information, see Chapter 9 Fire Protection.

MLG Bay Overheat Test

The MLG overheat detection system can be tested at the LDG GEAR control panel. The MLG BAY OVHT TEST switches simulate an overheat or failed condition and generate EICAS messages as explained above.

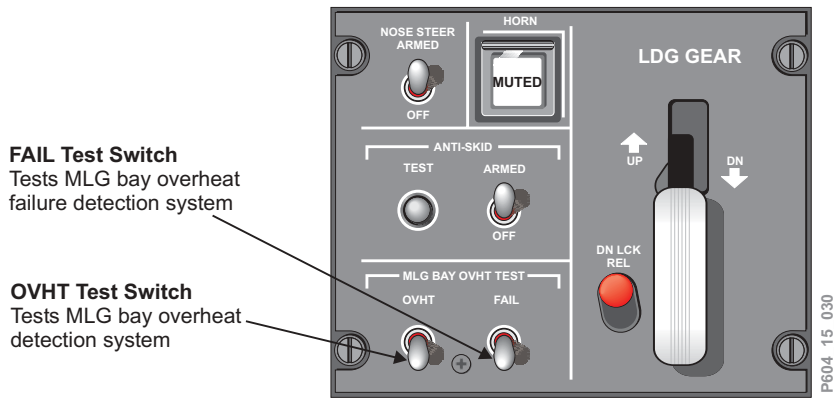

MLG BAY OVHT TEST Switches

Figure 15-6

Nosewheel Steering System

Description

The nosewheel steering system is hydraulically actuated through a steering actuator mounted on the nose landing gear assembly. There is no mechanical connection between the flight deck controls and the steering actuator. Nosewheel steering commands are transmitted electronically using “steer-by-wire” technology.

Components and Operation

The nosewheel steering system is armed by the NOSE STEER switch located on the LDG GEAR control panel. The system is activated when hydraulic system 3 is pressurized, the nose landing gear is down and locked and the PSEU “ground” mode is satisfied.

Steering control is initiated via the steering tiller and/or by the rudder pedals. Nosewheel deflection up to 55 degrees on either side of center is possible when using the steering tiller. Rudder pedal movement will deflect the nosewheel up to 7 degrees either side of center.

With the NOSE STEER switch selected to ARMED, the 55-degree limit may inadvertently be exceeded if sufficient differential braking is applied in the direction of the turn. When the 55-degree angle is exceeded, the nosewheel steering system is automatically disabled and the nosewheel casters freely to a maximum of 99 degrees.

NOTE

The nosewheel steering system cannot be reengaged unless the steering angle is less than 55 degrees and the NOSE STEER switch is selected to OFF and then to ARMED again.

Electronic Control Unit (ECU)

The nose steering electronic control unit (ECU) controls the electrohydraulic valve that directs hydraulic system 3 pressure to the steering actuator to turn the nosewheels. Nosewheel position feedback is sent to the ECU from transducers mounted on the steering actuator assembly.

In the air, the nosewheel is centered electronically by the ECU, and mechanically by centering cams as the oleo extends.

The ECU continuously monitors the nosewheel steering system. Any faults detected are annunciated on EICAS. Fault detection will result in steering system shutdown. When the steering system is shut down due to fault, or manually disarmed, nosewheel steering reverts to the free-castering mode (which allows nosewheel deflection up to

99 degrees either side of center), and the STEERING INOP caution EICAS message is displayed.

WARNING

ENSURE THAT THE NOSEWHEEL ASSEMBLY IS CLEAR OF PERSONNEL AND TOWING EQUIPMENT BEFORE SELECTING THE NOSEWHEEL STEERING SWITCH TO THE ARMED POSITION.

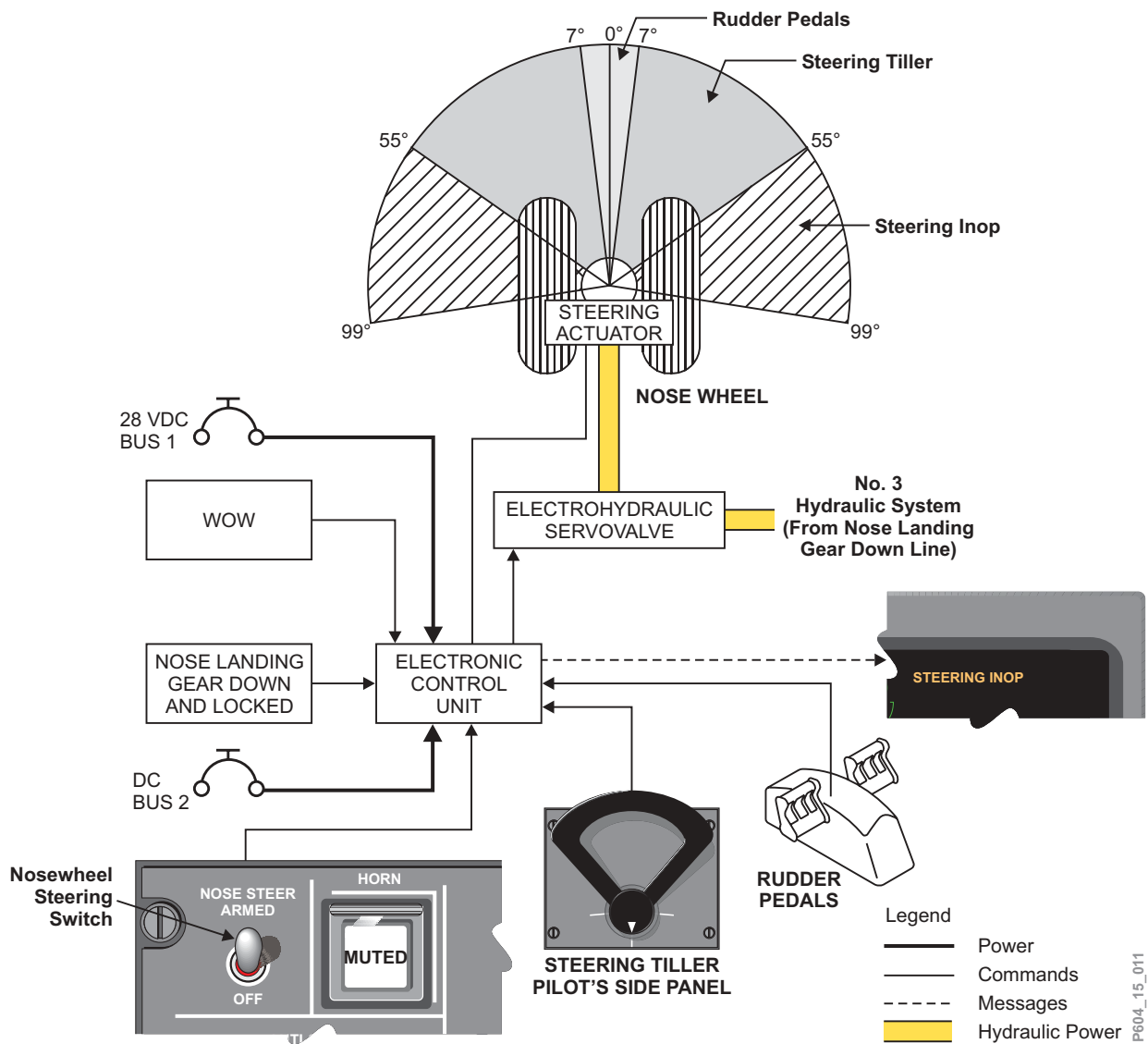

Steering Tiller

Figure 15-7

Wheels and Brakes

Description

Dual-wheel assemblies are installed on each main landing gear strut, and each main wheel is equipped with a carbon brake disk assembly. The nose gear has two wheels and uses chine tires to eject ground water away from the aircraft engines.

Components and Operation

Each wheel of the main landing gear is equipped with self-adjusting multidisc carbon brakes. Hydraulic system 3 powers the brakes of the inboard wheels and hydraulic system 2 powers the brakes of the outboard wheels. A parking brake function is available at both the inboard and outboard brakes. Anti-skid protection is provided.

Each main wheel has four fusible plugs that melt to prevent tire burst in the event of an overheated wheel or brake condition.

Brake application is initiated by pressing the brake pedals which are mechanically linked to the four associated brake control valves. The brake control valves meter hydraulic pressure to the brakes through anti-skid control valves.

During gear retraction, hydraulic pressure from the nose landing gear is directed to the brake control valves to stop main wheel rotation (in-flight braking).

In case of failure of hydraulic systems 2 or 3, accumulators in both hydraulic brake systems provide pressure for approximately six brake applications with the anti-skid selected off. Loss of either hydraulic system 2 or 3 results in a 50% reduction in braking capability. Braking remains symmetrical and anti-skid is available at the working brakes.

Two brake wear indicator pins are installed on each brake assembly to provide a visual indication of brake wear. When the end of the wear indicator pin is flush with the top of the indicator housing, the brake should be serviced.

NOTE

The brake wear indicator pins must be checked with the brakes applied and hydraulic systems 2 and 3 pressurized.

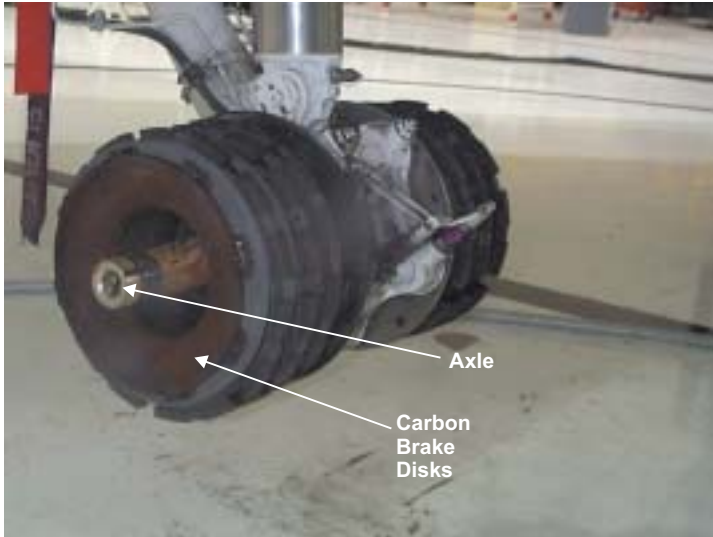

Brake Wear Indicator

P604_15_031

Brakes and Lower Main Gear Structure

Figure 15-8

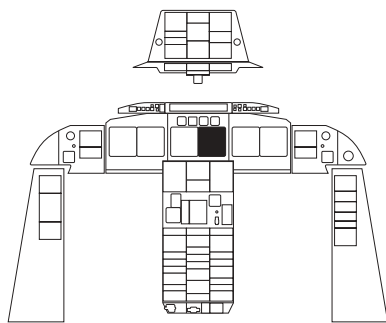

Inboard and Outboard Brake Pressure Readout

Indicates brake pressure of respective system. Readout in 50-psi increments.

Green – brake pressure is 1050 psi to 3200 psi.

White – brake pressure is greater than 3200 psi

Amber – brake pressure is less than 1015 psi.

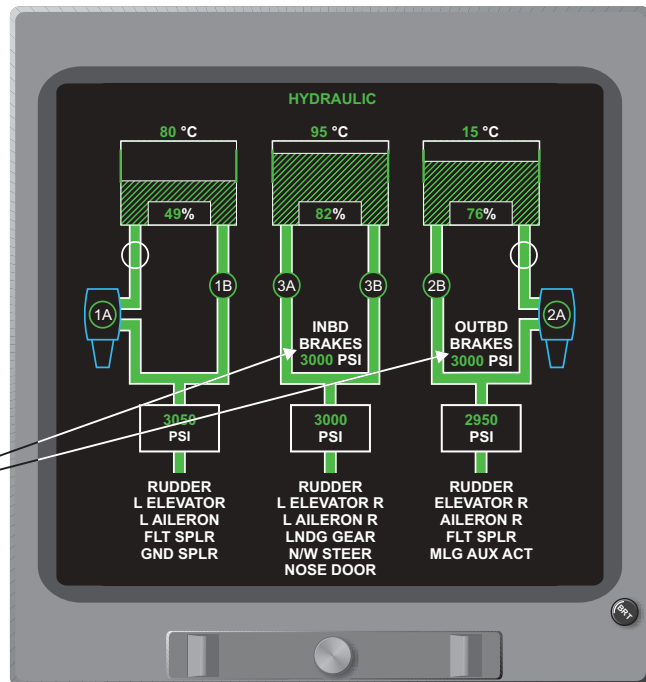

P604_15_020

Hydraulic Synoptic Page (Inboard and Outboard Brake Pressure)

Figure 15-9

Parking Brake

To apply the parking brake, fully depress both brake pedals on the pilot’s or copilot’s side, pull the parking brake handle and rotate it 90° to the locked position. To release, fully depress both brake pedals, rotate the parking brake handle to the unlocked position and push it down. Both the inboard and outboard brakes will hold when hydraulic systems 2 and 3 are pressurized and the parking handle is set. When the hydraulic systems are selected off, only the inboard brakes will hold for a prolonged period.

EICAS indicates normal parking brake engagement with the PARKING BRAKE ON advisory EICAS message.

If the parking brake is engaged with the aircraft in takeoff mode, a PARKING BRAKE warning EICAS message will be displayed and an aural “CONFIG BRAKE” warning will sound.

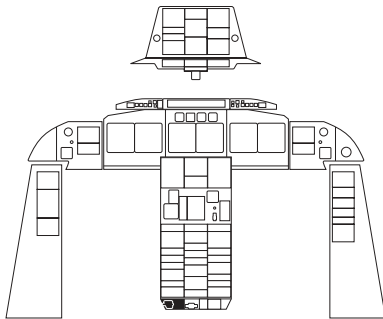

Parking Brake Handle

To engage parking brake:

- while fully depressing both brake pedals on the pilot’s or copilot’s side, pull parking brake handle and rotate it 90° to the locked position.

To disengage parking brake:

- while fully depressing both brake pedals on the pilot’s or copilot’s side, rotate the parking brake handle to the unlocked position and push it down.

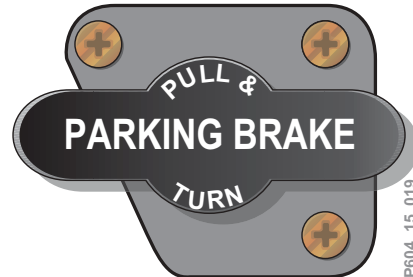

P604_15_019

Parking Brake Handle

Figure 15-10

Anti-Skid System

The anti-skid system consists of a dual-channel (inboard and outboard) anti-skid control unit (ASCU), four axle-mounted speed transducers, and four anti-skid control valves. The anti-skid system independently controls the braking of each main wheel by modulating the hydraulic pressure applied to each brake.

Rotational speed of each wheel and its rate of deceleration are sensed by the wheel speed transducers and the data is transmitted to the ASCU. The ASCU modulates the hydraulic pressure at the brake to prevent wheel lockup.

Comparing the speed of paired wheels provides a second level of anti-skid protection. The inboard wheels form one pair, the outboard wheels the other. If, for example, the right inboard wheel rotates at a significantly slower speed than the left inboard, the ASCU releases the brake on the slower turning wheel. When both paired wheels return to the same speed, the ASCU reapplies the released brake.

The ARMED switch on the ANTI SKID control panel arms the system when the parking brake is not engaged and both MLG are down and locked. In air mode, (no WOW signal), the ASCU configures the anti-skid valves to full brake dump to prevent wheel lockup at touchdown. The system becomes operational when a 35-knot wheel spin-up signal is generated or a WOW signal is present after a 5-second delay. The anti-skid system is functional down to a minimum wheel speed of 10 knots.

Anti-Skid Test

The TEST button on the LDG GEAR control panel initiates a built-in test of the ASCU and associated components, during which time the A/SKID IN TEST advisory EICAS message will be displayed. The test can only be performed with the parking brake off.

Controls and Indicators

The landing gear system provides control of the landing gear, brakes, anti-skid and the overheat warning systems. Flight deck controls activate normal gear extension and retraction, emergency gear extension, nosewheel steering, warning horn mute, anti-skid operations and anti-skid test functions.

The EICAS primary page presents indications of landing gear position.

LANDING GEAR / BRAKES

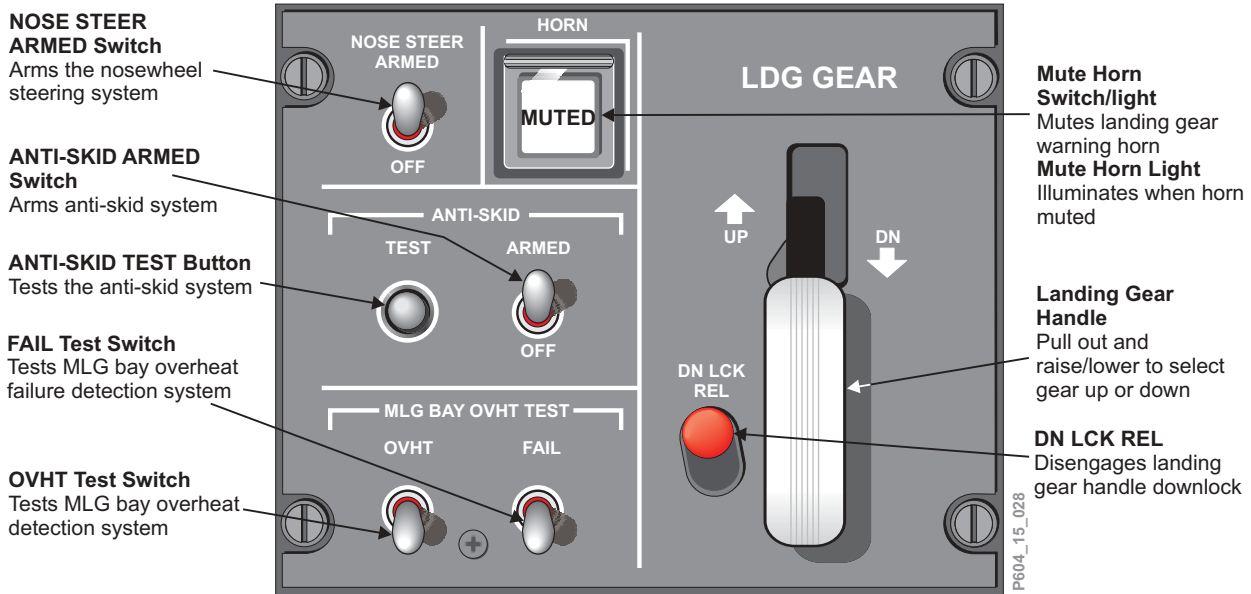
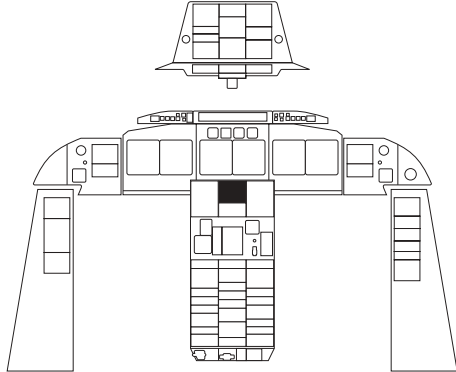

Landing Gear Panel

Figure 15-11

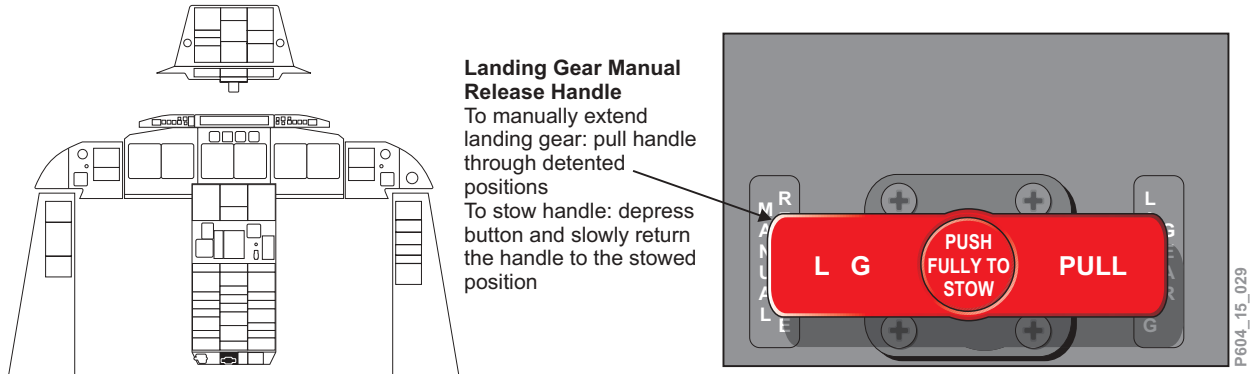

Landing Gear Manual Release

Figure 15-12

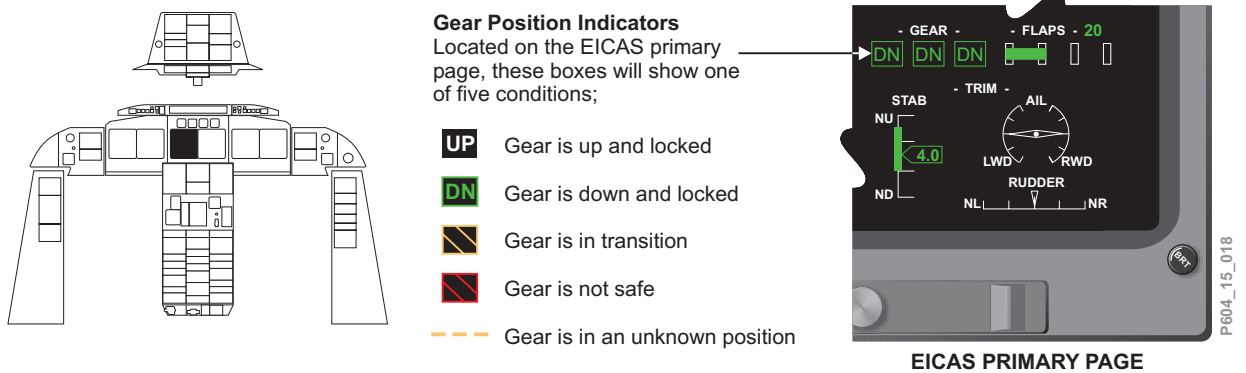

Landing Gear EICAS Displays

Figure 15-13

EICAS Messages

MESSAGE	MEANING	AURAL WARNING (IF ANY)
GEAR DISAGREE	Landing gear position does not match the gear lever position.	"GEAR DISAGREE"
MLG BAY OVHT	High temperature detected in the main landing gear wheel bins.	"GEAR BAY OVERHEAT"
NOSE DOOR OPEN	Nose doors are open 10 seconds after the landing gear is locked in position, or when airspeed is > 250 KIAS.	"NOSE DOOR"
PARKING BRAKE	The parking brake is set with the aircraft in the takeoff mode with N ₁ greater than 70% rpm.	"CONFIG BRAKE"
A/SKID INBD	The respective anti-skid channel has failed or is not armed.	
A/SKID OUTBD		
INBD BRAKE PRESS	The respective brake system pressure is below 1015 psi.	
OUTBD BRAKE PRESS		
MLG OVHT FAIL	The overheat detection loop in the gear bay is shorted out.	
PARK BRAKE SOV	The parking brake shutoff valve does not match the commanded position.	
PROX SYS	Indicates a failure in the PSEU output circuitry (may be accompanied by GND SPLRS message).	
STEERING INOP	Nosewheel steering has failed.	
WOW INPUT	The PSEU is unable to determine if the aircraft is airborne or on the ground (WOW CH 1 & CH 2 disagree).	
WOW OUTPUT	One or more of the PSEU outputs do not match the input.	
A/SKID IN TEST	Anti-skid system is in self-test.	
PARKING BRAKE ON	The parking brake is activated, aircraft not in takeoff mode (WOW and N ₁ less than 70% rpm).	
PROX SYS FAULT	Indicates a failure in the proximity sensor electronics unit.	
WOW OUTPUT FAIL	Indicates a weight-on-wheels output fault in a noncritical system.	

EICAS Messages

Table 15-4