

TABLE OF CONTENTS

	Page
Introduction	8-1
Description	8-2
Placards	8-2
Oxygen	8-3
Flight Compartment	8-3
Oxygen Bottle	8-4
Oxygen Ground Service Panel	8-5
Crew Mask Storage	8-6
Crew Mask	8-7
Passenger Oxygen	8-9
Oxygen System	8-10
EICAS Messages	8-10
Quantity Readout	8-11
Crew Oxygen Consumption Data	8-12
Evacuation Devices	8-13
Exit Lighting	8-14
Emergency Exit - Passenger Door	8-14
Overwing Emergency Exit	8-14
Overwing Emergency Exit – External	8-15
Overwing Emergency Exit – Internal	8-16
Fire Fighting Equipment	8-17
Portable Fire Extinguishers	8-17
Portable Fire Extinguisher	8-18
Over Water Emergency Equipment	8-19
Life Vest	8-19
EMS Circuit Protection	8-21

PAGE INTENTIONALLY LEFT BLANK

INTRODUCTION

Today's technology has enabled aircraft manufacturers to build larger, better and more reliable aircraft. Even as on board emergencies such as fires, rapid decompression, ditching or emergency evacuations become unlikely, it remains important that aircraft be equipped with the proper emergency equipment and that the crew be cognizant of the equipment available and its proper functioning.

This chapter will introduce the standard emergency equipment available on the Global. It is important to note that each Global will differ in the location of this equipment. It is essential that the crew brief new members as well as passengers on safety procedures to ensure the maximum safety during flight.

This emergency equipment includes:

- Emergency locator transmitter
- Evacuation devices (exits, crash axe)
- Exit lighting
- Fire fighting equipment (portable fire extinguisher)
- First aid kits (MEDAIR)
- Oxygen equipment (fixed and portable)
- Over water emergency equipment (life vests, life rafts)

Aircrew must refer to their Aircraft Operating Manual for the use of Completion Center installed items.

Data on airplane doors and emergency exits is contained in Chapter 1, AIRPLANE GENERAL. Data on the emergency lighting system is contained in Chapter 15, LIGHTING.

DESCRIPTION

This chapter describes the systems and equipment which are essential to the safety of passengers and crew during a fire, rapid decompression, ditching and emergency evacuation. These include the following equipment:

- Oxygen equipment (portable and fixed)
- Evacuation devices (crash axe, emergency lighting and emergency exits)
- Fire fighting equipment (portable and fixed)
- Over water emergency equipment (life vests)

PLACARDS

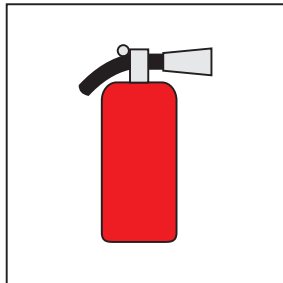

**HALON FIRE
EXTINGUISHER**

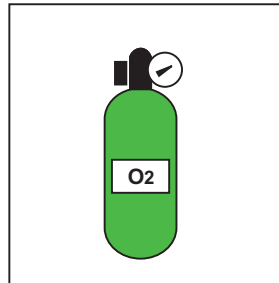

OXYGEN CYLINDER

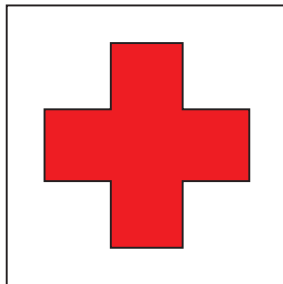

FIRST AID KIT



GX_08_001

OXYGEN

A gaseous oxygen system is supplied by four cylinders to serve the flight crew and passengers.

FLIGHT COMPARTMENT

The flight compartment oxygen consists of the following:

- Four oxygen bottles (with a pressure regulator unit, bottle gauge, and shutoff valve)
- Ground servicing panel (with a gauge and filler valve)
- Fuselage-mounted overboard relief valve (frangible disc)
- Two oxygen mask/regulator units and goggles

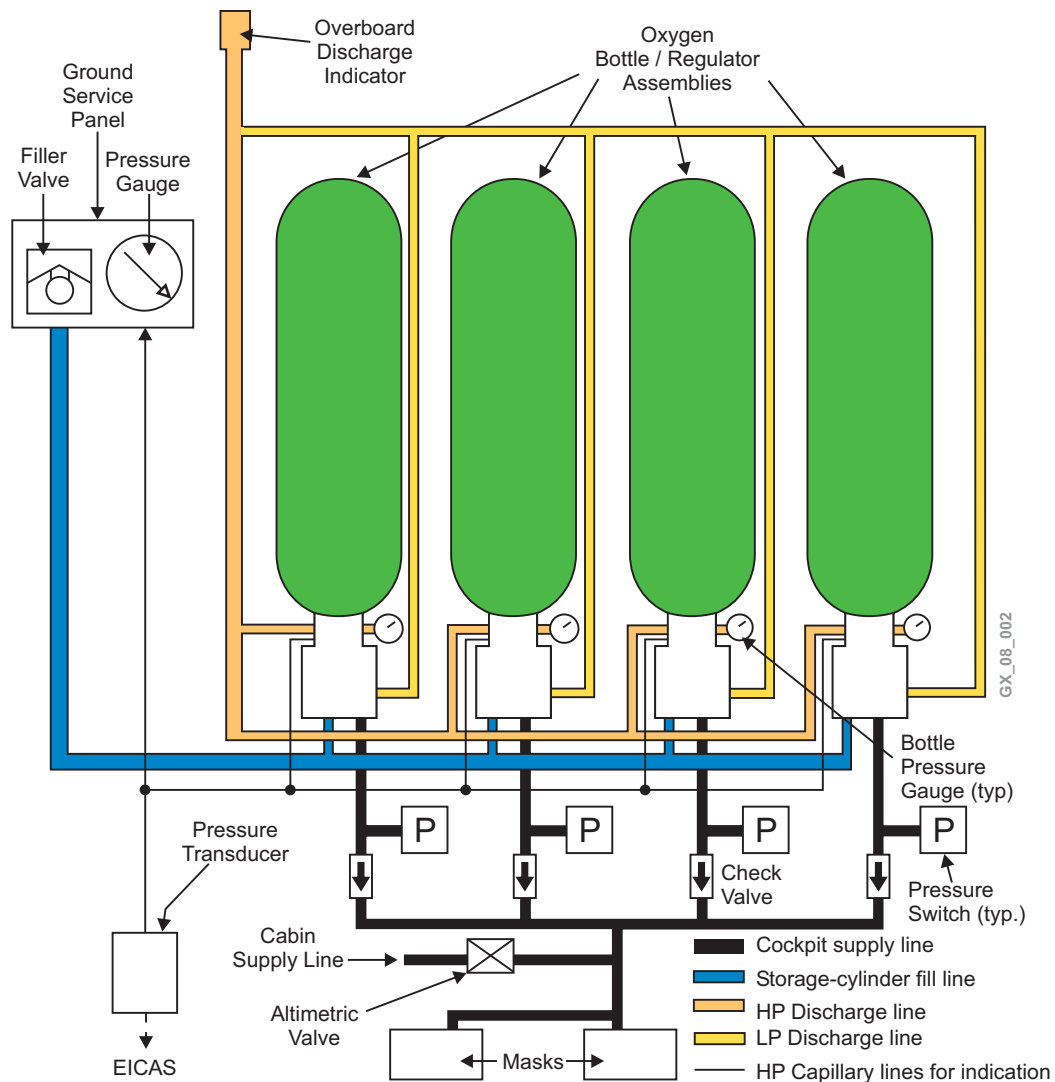

OXYGEN BOTTLE

The oxygen bottles [1418 liter (50.1 cubic feet)] are located in the forward fuselage underfloor area. Normal charge pressure at 21°C (70°F) is 1850 psi.

Charge pressure is indicated as follows:

- Gauge on the bottle shutoff valve
- Gauge on the ground servicing panel
- Oxygen quantity is indicated on the EICAS status page

When bottle pressure becomes excessive, approximately 2600 psi, all oxygen is vented overboard by a pressure regulator unit working in conjunction with a fuselage-mounted relief valve. Overpressure causes the OXY HP RELIEF disc, located on the left front fuselage, to blow out.

The pressure regulator unit regulates flow to the crew mask regulator unit to 72.5 psi and the unit's strain gauge transmits pressure signals to EICAS.

The crew mask/regulator unit regulates the flow to the crew masks. Oxygen is supplied via the regulator at either ambient or slightly over ambient pressure dependent upon crew setting of the flow controls.

The flight crew oxygen system is a diluter demand system. The flight crew oxygen masks are of the quick-donning, inflatable harness type. Each mask is stowed in a quick access container adjacent to each flight station (one each at the side consoles).

A regulator in each mask provides, by pilot selection, three different oxygen supply modes:

- Normal diluted demand mode
- 100 percent oxygen on demand mode
- 100 percent oxygen continuous flow pressure mode

When stowed in the container, the oxygen flow through the regulator can be tested by pressing the test lever. Each mask is equipped with a microphone.

In the event of cabin depressurization, oxygen for the passengers is supplied by the same oxygen system as for the crew, via the altimetric valve to the passenger drop out mask boxes in the cabin.

The oxygen masks are installed in overhead compartments and are available at all passenger seats and in the lavatories.

All oxygen compartment doors will open to present the oxygen masks automatically if cabin altitude reaches approximately 14,500 feet.

When the oxygen compartment doors open, the passengers will pull the oxygen mask to their face, pulling the lanyard and pin from the generator. This initiates the flow of oxygen to the passenger's oxygen mask.

OXYGEN GROUND SERVICE PANEL

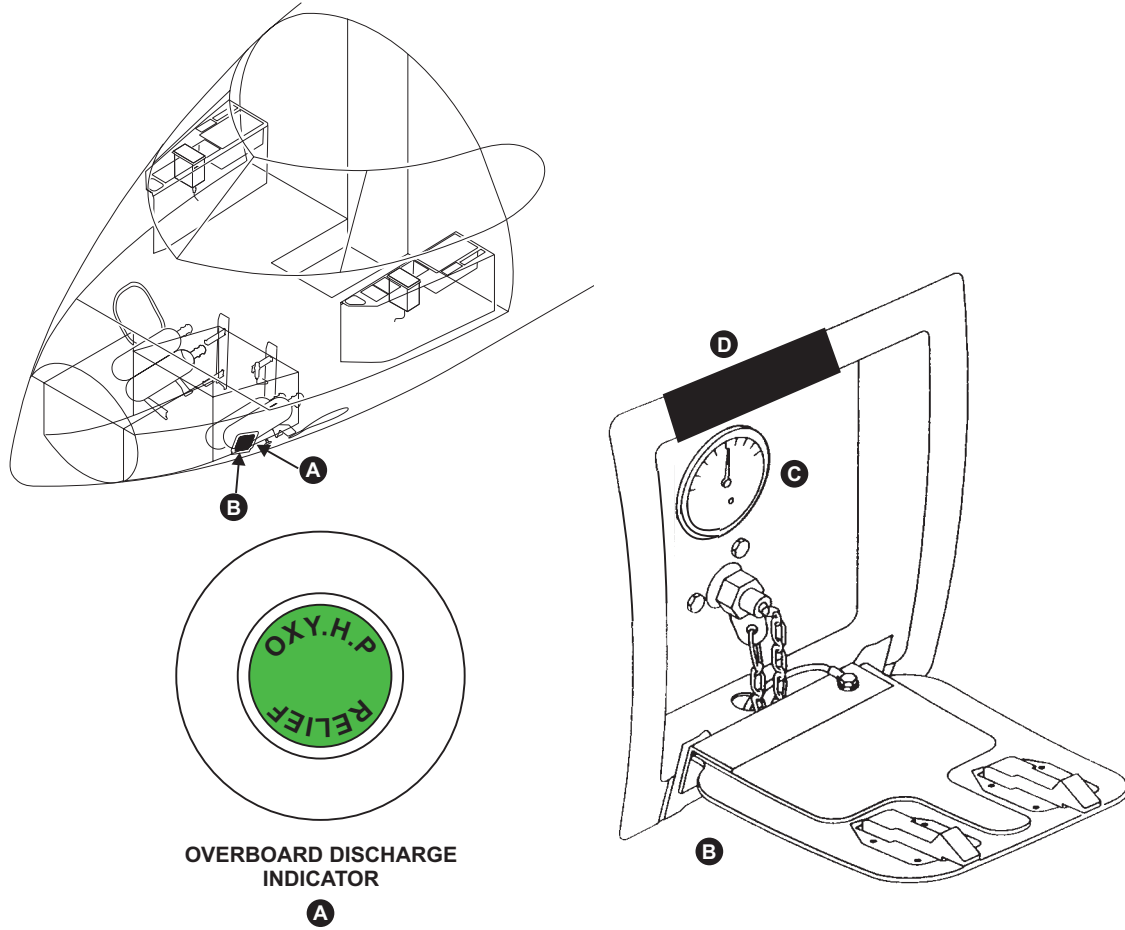

OVERBOARD DISCHARGE INDICATOR

OXYGEN CYLINDER SERVICING: CHARGE CYLINDER AT RATE NOT TO EXCEED 200 PSI/MIN TO "FULL" PRESSURE								
AMBIENT TEMP °F	100	80	60	40	20	0	-20	-40
FULL PRESS PSI	1990	1900	1805	1710	1620	1530	1435	1340

GX_08_003

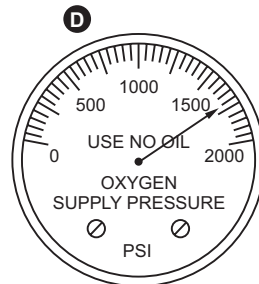

GROUND SERVICE PANEL PRESSURE GAUGE

CREW MASK STORAGE

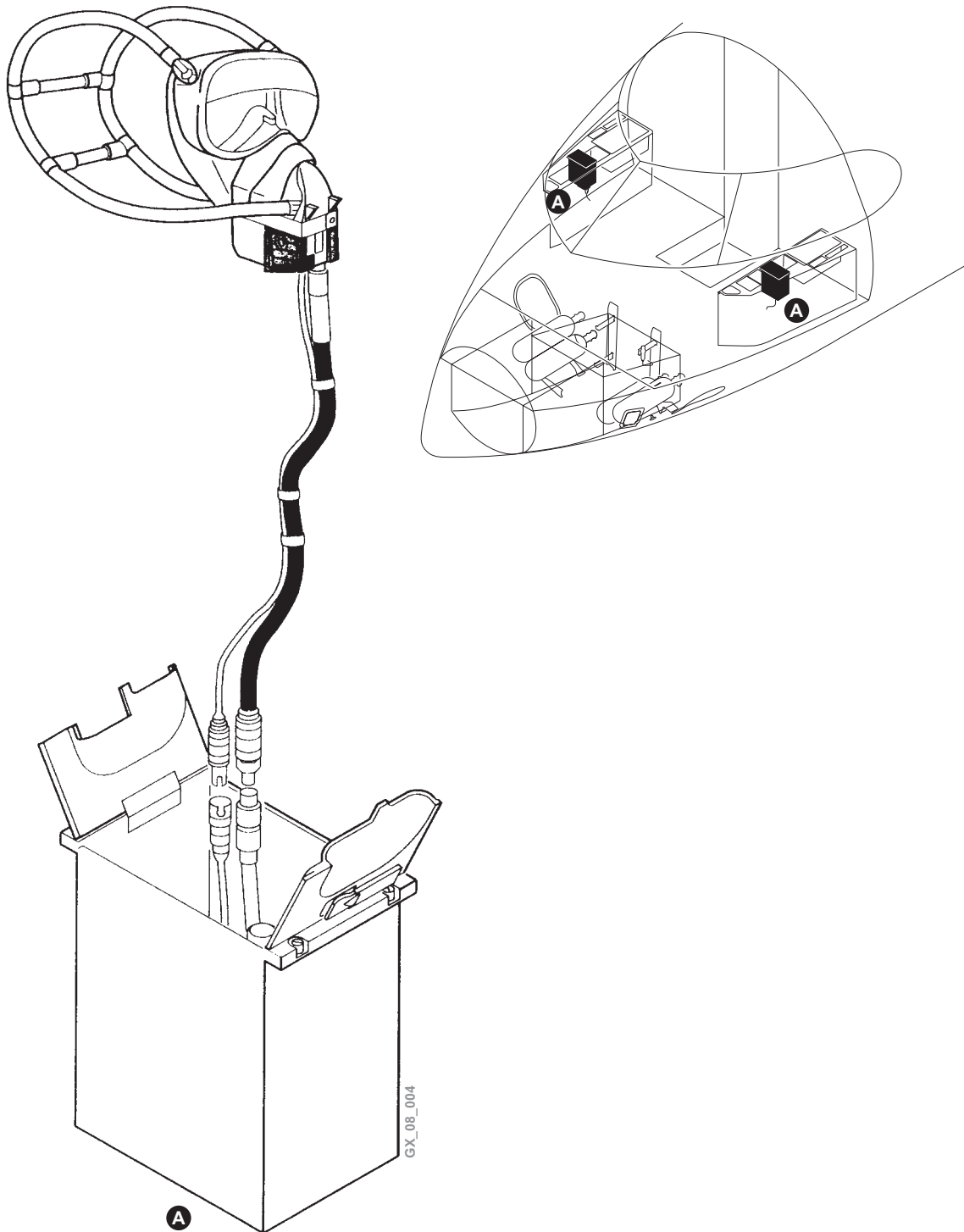

CREW MASK

Blinker

Shows yellow cross when oxygen is flowing or when harness is inflated. When black, indicates no oxygen flow.

Normal/100% Lever

- **N** provides a mixture of Ambient air with oxygen on demand.
- **100%** provides 100% oxygen on demand.

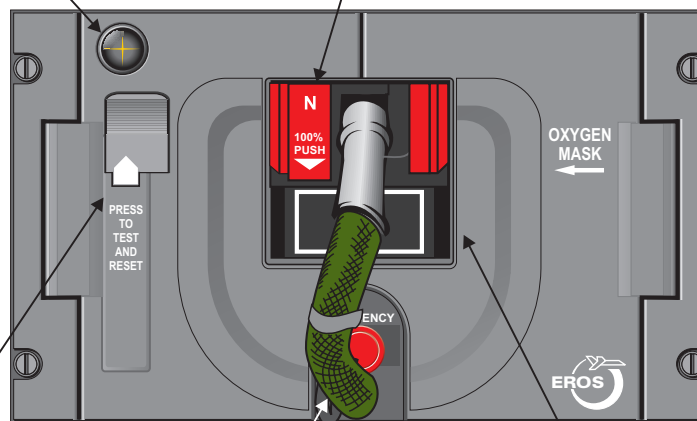

RESET/TEST Lever (spring-loaded to RESET)

Press to test oxygen flow (momentarily) through the regulator (microphone test without pulling the mask out).

Oxygen Supply Hose

Release Levers

Squeeze to unlock container doors, grasp levers and hose and pull to withdraw mask.

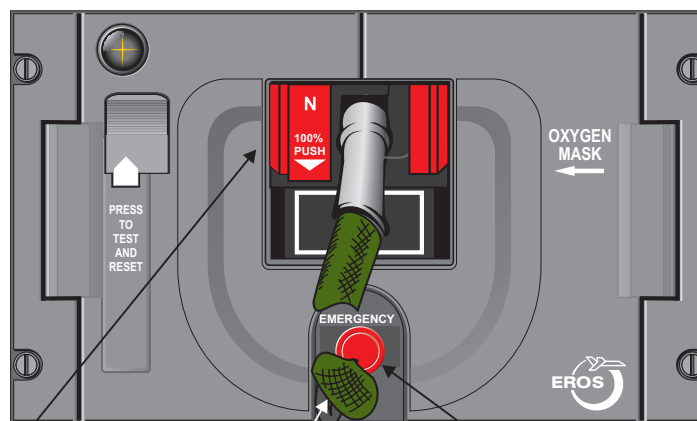

Oxygen On Flag

In view, when mask is out. Indicates that oxygen shutoff valve is open. Flag will disappear when shutoff valve closed. Reset position shuts off supply to mask regulator and blinker unit.

Oxygen Supply Hose

Emergency Flow Control

- Located on panel under the oxygen supply hose.
- Rotate on in direction of arrow to supply emergency pressure.
- Press to check whether emergency pressure flow will be available.

GX_08_005

CREW MASK

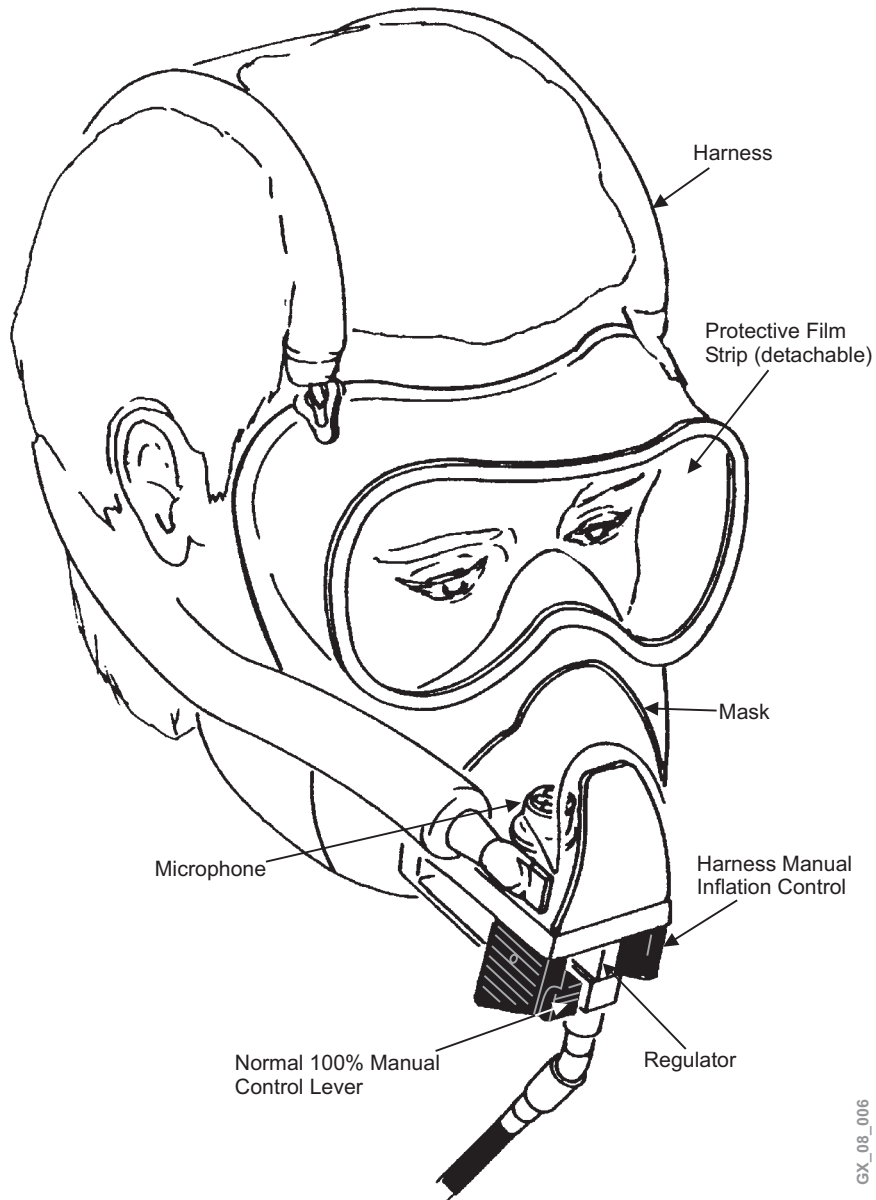

GX_08_006

PASSENGER OXYGEN

The passenger oxygen control panel located on the copilot's side panel has a rotary switch that lets the crew choose between three operating modes of the altimetric valve.

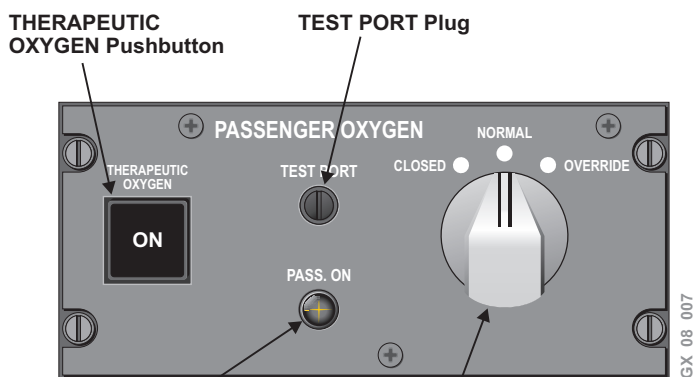

PASS ON Flow (eye) Indicator
Indicates flow of oxygen to the passenger compartment

Altimetric Valve Rotary Selector

The three modes of operation are:

CLOSED – Stops oxygen supply to the passenger compartment.

NORMAL – Supplies oxygen and sheds cabin power automatically to the passenger compartment when cabin altitude reaches 14,500 feet (+500/-750 feet).

OVERRIDE – Overrides the altitude switch in the control panel. Supplies oxygen to the passenger compartment and sheds cabin power regardless of altitude.

When the cabin altitude reaches 14,500 feet (+500/-750 feet), a message will appear on EICAS, when the altimetric valve is set at NORMAL and there is oxygen flow in the passenger compartment.



OXYGEN SYSTEM

EICAS MESSAGES

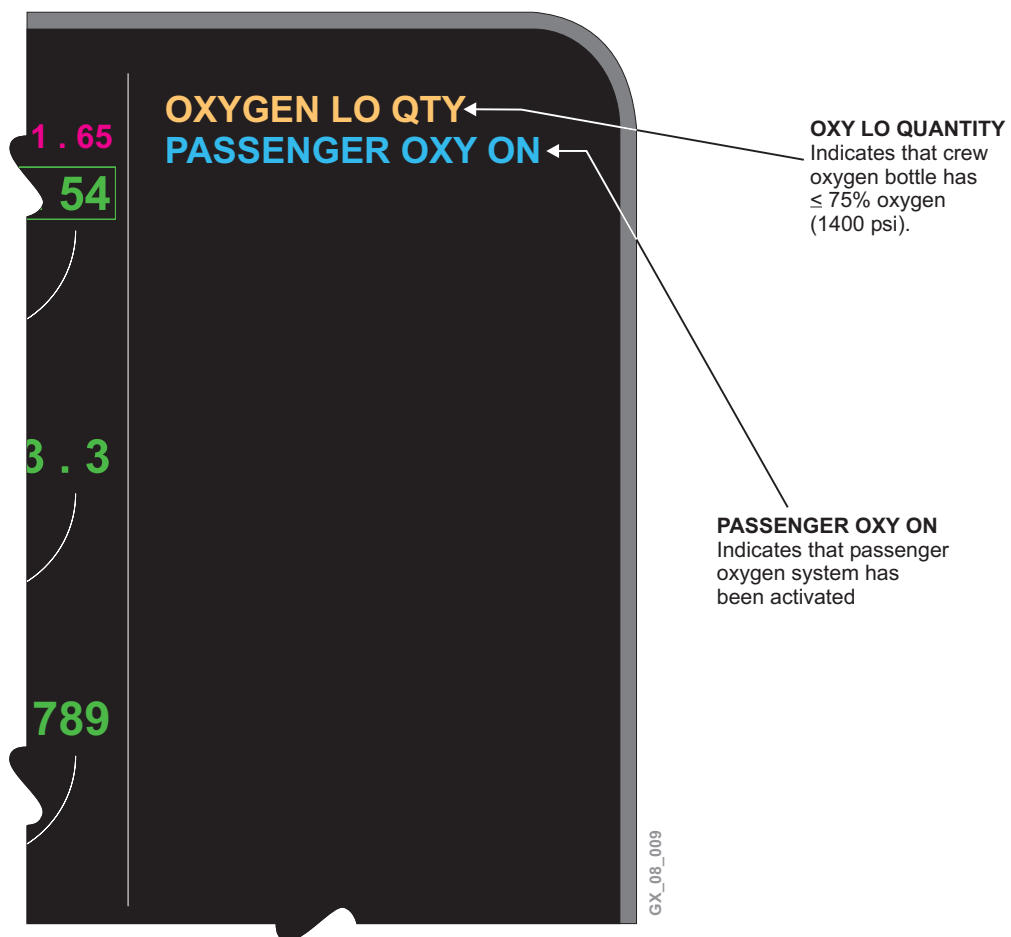

QUANTITY READOUT

**Crew Oxygen System
Quantity Readout**
Indicates oxygen
system quantity in
increments of 1%
Colors are:
Amber – ≤ 75%
Green – > 75%

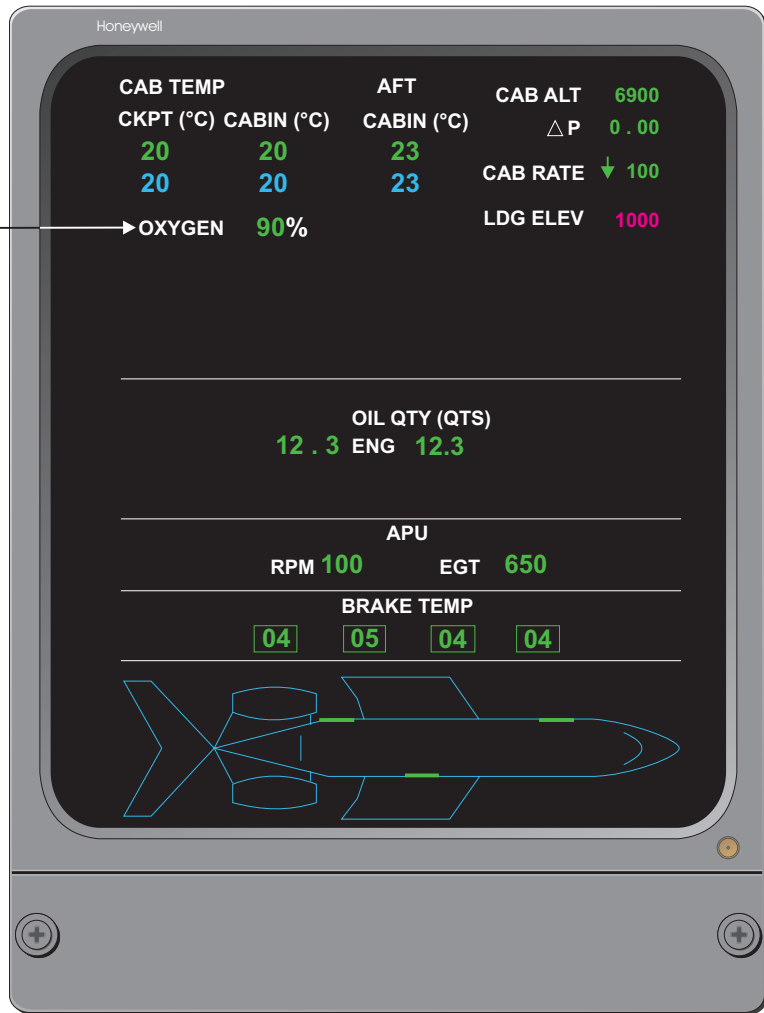

CREW OXYGEN CONSUMPTION DATA

The following tables show the total time (in hours and minutes) that oxygen will be available at various mask settings, during various flight conditions, at initial bottle pressures of 75% psi and 100% psi. A margin of safety of 10% was subtracted from the full charge of 100% psi in all cases. Note that passenger oxygen consumption was not a factor in the creation of these tables.

LEVEL FLIGHT AT CABIN PRESSURE ALTITUDE OF 8,000 FEET				
Crew members	2		3	
Initial Bottle Pressure	75%	100%	75%	100%
Normal Mask Setting	10 hrs 02 min	13 hrs 37 min	06 hrs 41 min	09 hrs 05 min
100% Mask Setting	02 hrs 12 min	02 hrs 59 min	01 hrs 28 min	01 hrs 59 min
Emergency Mask Setting	02 hrs 04 min	02 hrs 49 min	01 hrs 23 min	01 hrs 52 min

DESCENT (10 MIN.) FROM 41,000 FEET TO LEVEL FLIGHT AT SAFE ALTITUDE (NORMAL MASK SETTING FOR BOTH DESCENT AND LEVEL FLIGHT)				
Crew members	2		3	
Initial Bottle Pressure	75%	100%	75%	100%
Cabin Pressure Altitude	10,000 feet	10 hrs 28 min	14 hrs 52 min	06 hrs 52 min
	14,000 feet	10 hrs 05 min	14 hrs 17 min	06 hrs 37 min
	18,000 feet	08 hrs 25 min	11 hrs 56 min	05 hrs 32 min
	21,000 feet	07 hrs 02 min	09 hrs 57 min	04 hrs 37 min

DESCENT (10 MIN.) FROM 41,000 FEET TO LEVEL FLIGHT AT SAFE ALTITUDE (100% MASK SETTING FOR DESCENT AND NORMAL MASK SETTING LEVEL FLIGHT)				
Crew members	2		3	
Initial Bottle Pressure	75%	100%	75%	100%
Cabin Pressure Altitude	10,000 feet	10 hrs 17 min	14 hrs 41 min	06 hrs 41 min
	14,000 feet	09 hrs 58 min	14 hrs 11 min	06 hrs 31 min
	18,000 feet	08 hrs 22 min	11 hrs 53 min	05 hrs 29 min
	21,000 feet	07 hrs 01 min	09 hrs 56 min	04 hrs 37 min

DESCENT (10 MIN.) FROM 41,000 FEET TO LEVEL FLIGHT AT SAFE ALTITUDE (100% MASK SETTING FOR BOTH DESCENT AND LEVEL FLIGHT)				
Crew members	2		3	
Initial Bottle Pressure	75%	100%	75%	100%
Cabin Pressure Altitude	10,000 feet	02 hrs 04 min	02 hrs 57 min	01 hrs 21 min
	14,000 feet	02 hrs 18 min	03 hrs 17 min	01 hrs 30 min
	18,000 feet	03 hrs 01 min	04 hrs 17 min	01 hrs 59 min
	21,000 feet	03 hrs 30 min	04 hrs 58 min	02 hrs 18 min

EVACUATION DEVICES

To assist in emergency escape and aid in rescue operation, emergency lighting, emergency exits, a crash axe and escape rope, are provided:

- Crash axe - Behind copilot's seat

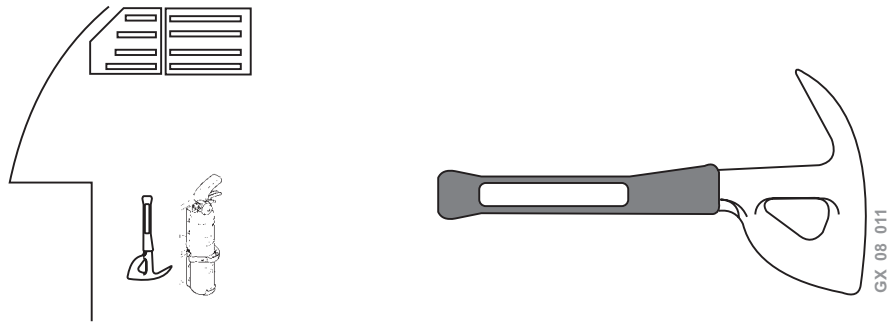

- Cabin escape rope - Access panel adjacent to overwing exit

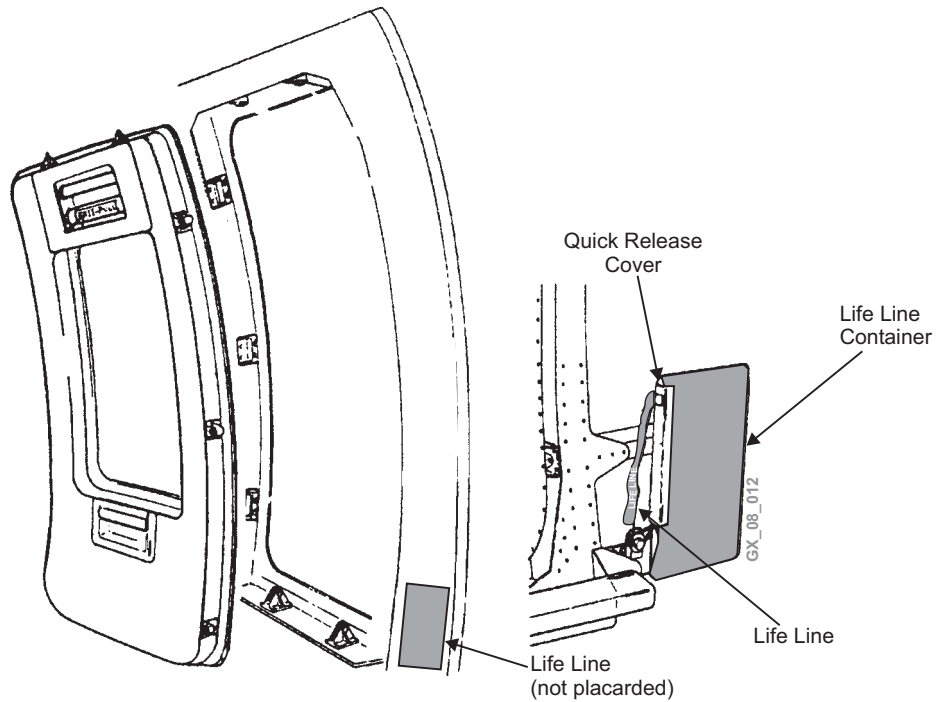

EXIT LIGHTING

The airplane is equipped with an emergency lighting system consisting of:

- Four floodlights for illumination of the passenger cabin
- Internal floodlights at the passenger door
- Exterior evacuation floodlights at the passenger door and overwing exit areas
- An escape path marking system at floor level

The system is powered by four 28-volt rechargeable self-contained Power Supply Units that supply power for approximately 20 minutes when charged (see Chapter 15, LIGHTING for details).

EMERGENCY EXIT - PASSENGER DOOR

This floor level door provides the most normal means of Type I emergency exits and should be used if possible.

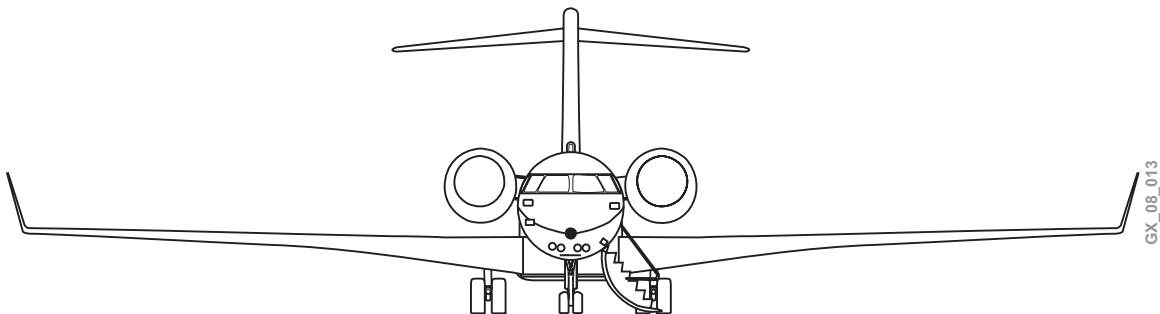

OVERWING EMERGENCY EXIT

There is one Type III overwing emergency exit window over the right wing of the airplane and provides access to the upper wing surface. The exit opens inward from the top with a pull handle on the inside and a push plate on the outside. An escape rope (life line) is provided at the overwing exit.

OVERWING EMERGENCY EXIT – EXTERNAL

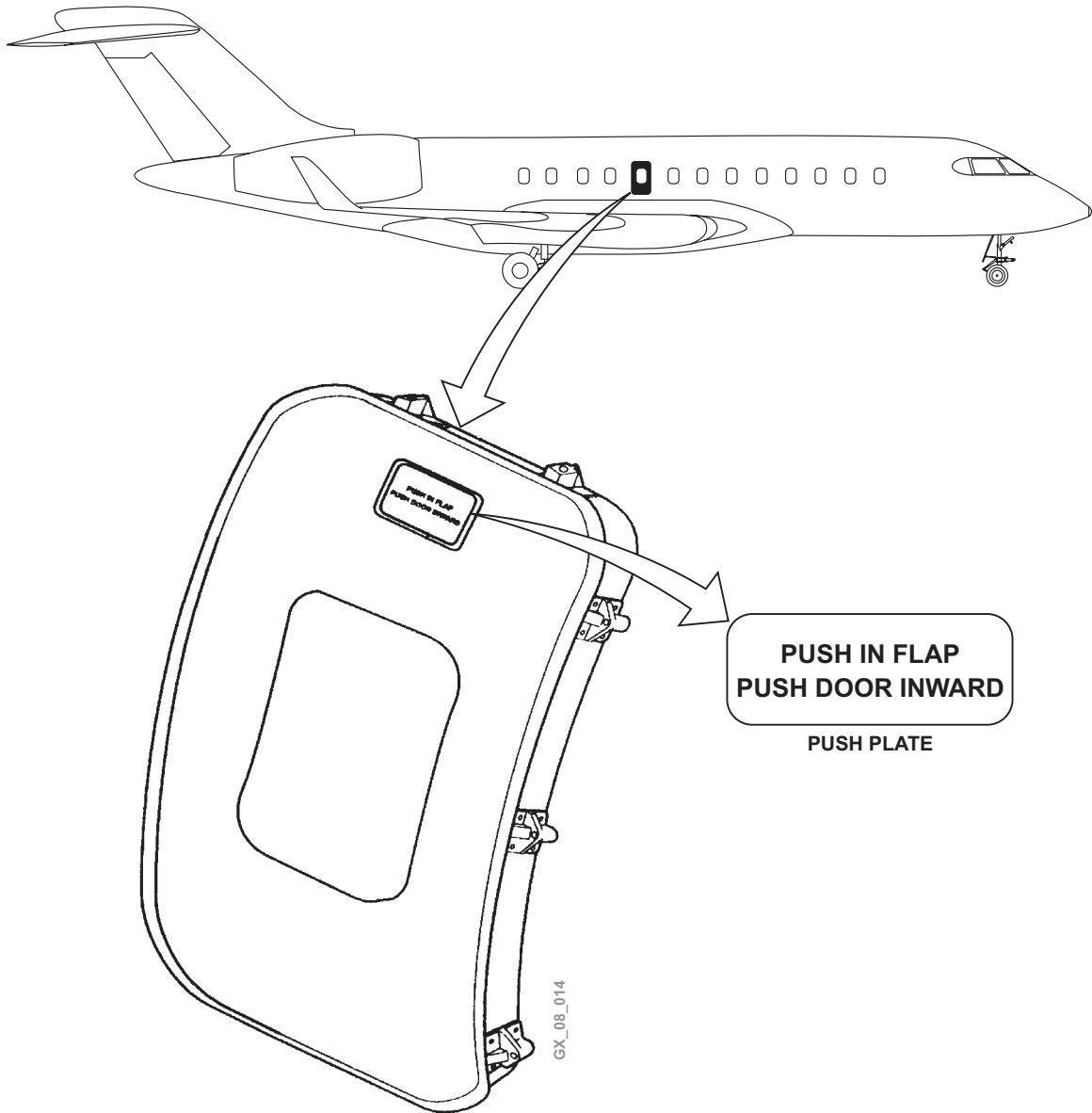

OVERWING EMERGENCY EXIT – INTERNAL

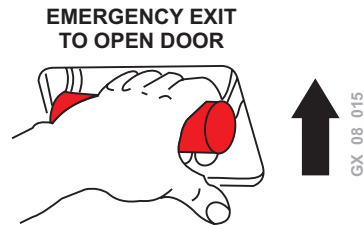
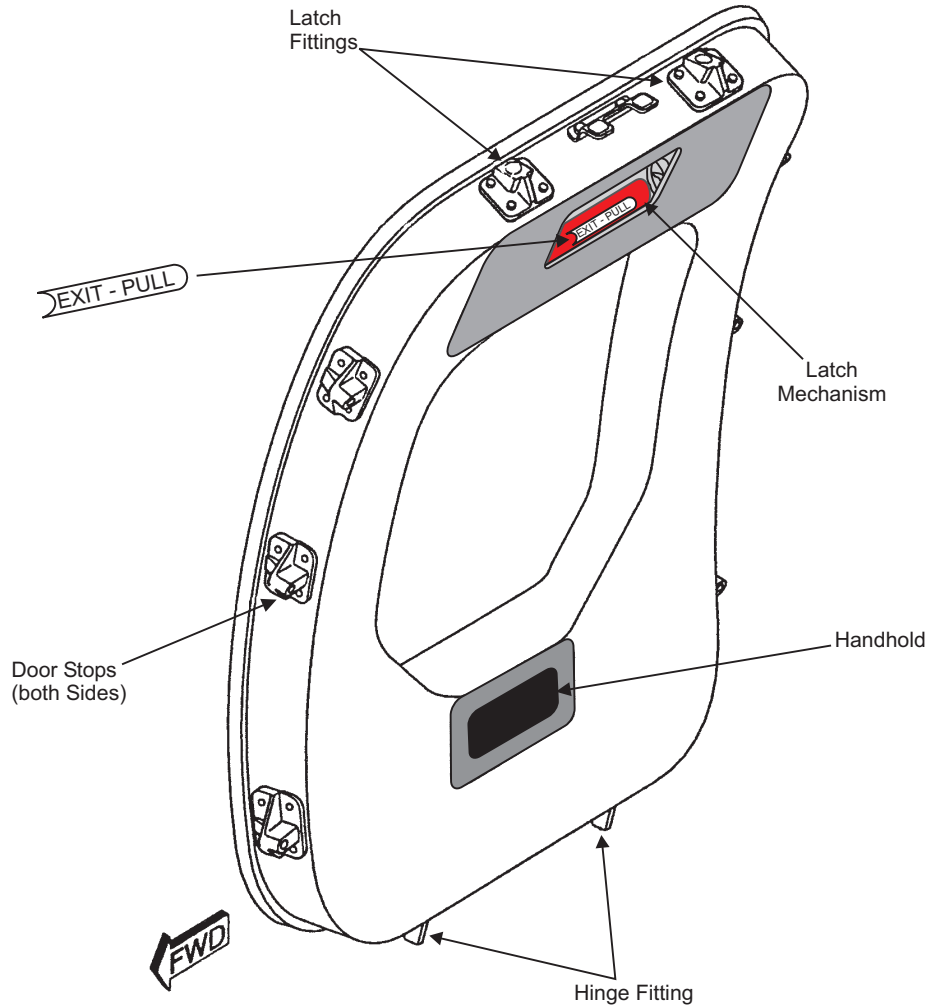

FIRE FIGHTING EQUIPMENT

To fight a fire occurring inside the flight compartment and/or in the passenger cabin, the following equipment has been provided:

- Portable fire extinguishers
- Crash axe (behind copilot’s seat)

PORTABLE FIRE EXTINGUISHERS

A hand-operated fire extinguisher, located in the flight compartment, containing Halon 1211 is provided. Halon 1211 is effective on electrical, oil and fuel fires, and is suitable for use in cold weather.

To operate: Remove from stowage bracket. Hold extinguisher upright in either hand, slide the (red) locking button down with thumb, aim the nozzle towards the base of the fire and press lever. Discharge stops when lever is released. Effective discharge time of 2-1/2 pound bottle is 8-15 seconds. Ventilate the compartment promptly after successfully extinguishing the fire to reduce gasses produced by fire and Halon. A distance of 9 to 15 feet, from very hot fires, or fires generating a dangerous amount of smoke, is recommended. If the discharge lever is held in the on position, the extinguisher is fully discharged in 10 seconds.

WARNING

**IF A FIRE EXTINGUISHER IS TO BE DISCHARGED IN THE FLIGHT COMPARTMENT, ALL FLIGHT CREW MUST WEAR OXYGEN MASKS WITH EMERGENCY SELECTED (100% OXYGEN).
CREW EXPOSURE TO HIGH LEVELS OF HALON VAPORS MAY RESULT IN DIZZINESS, IMPAIRED COORDINATION, AND REDUCED MENTAL SHARPNESS.**

The fire extinguisher is effective in fighting Class A, B and C fires.

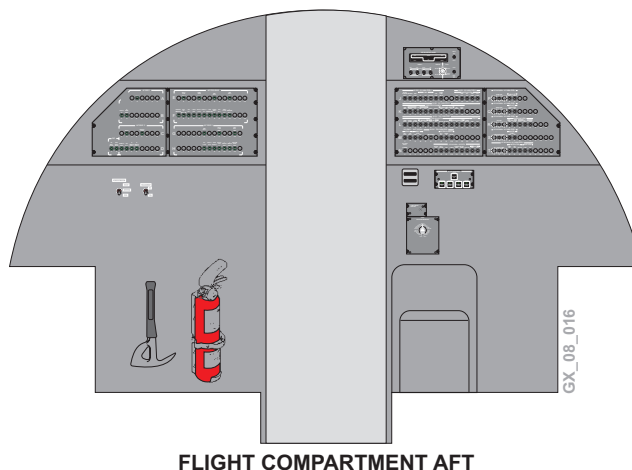

PORTABLE FIRE EXTINGUISHER

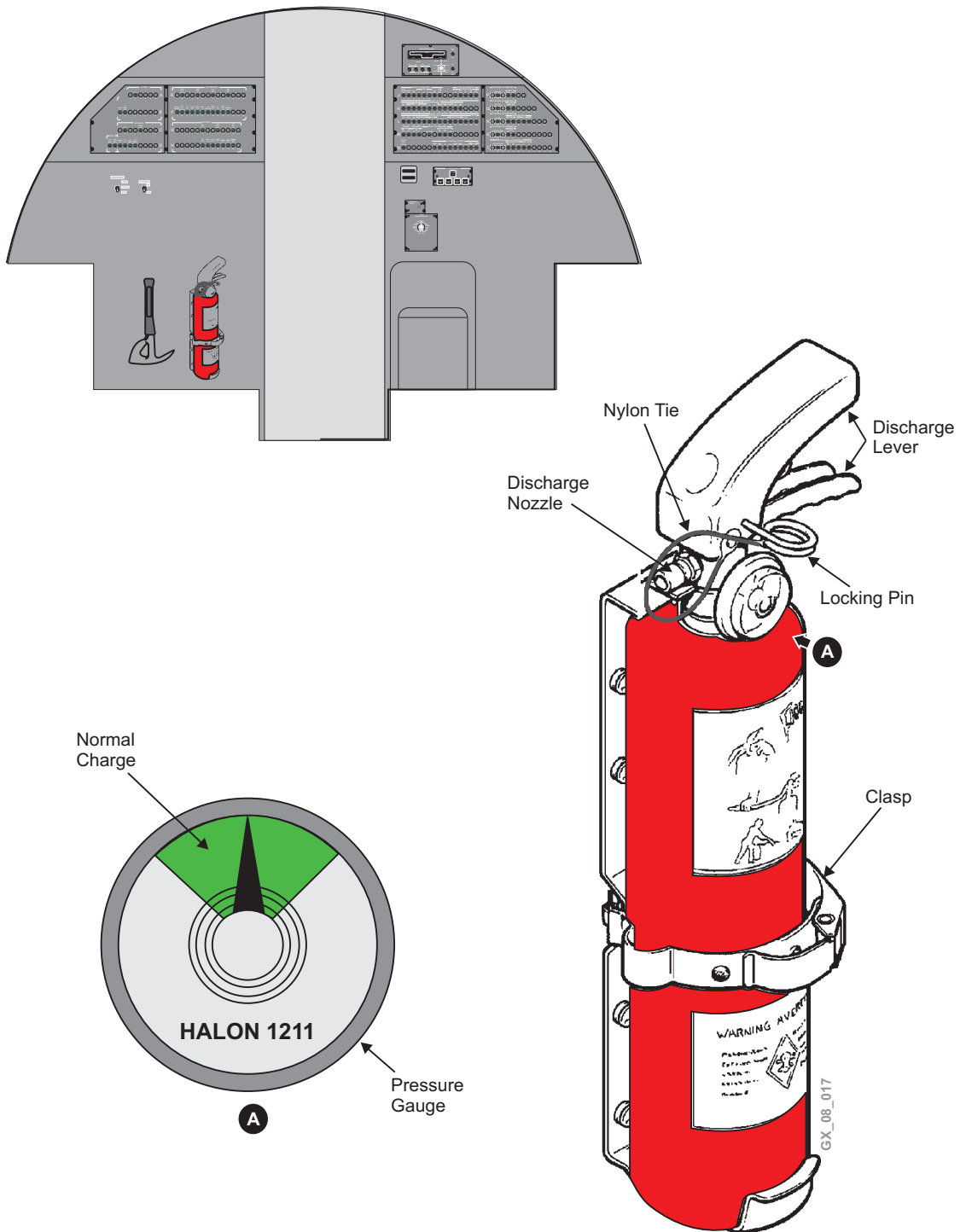

OVER WATER EMERGENCY EQUIPMENT

A life vest for each occupant of the flight compartment and the cabin is provided.

Each life vest includes a manual and an oral inflation system, a locator light, and a system for automatic battery plugs removed during life vest deployment.

The flight crew members' life vests are stowed in a pocket beneath the crew member's seat.

The passenger life vests are stowed under each passenger seat.

LIFE VEST

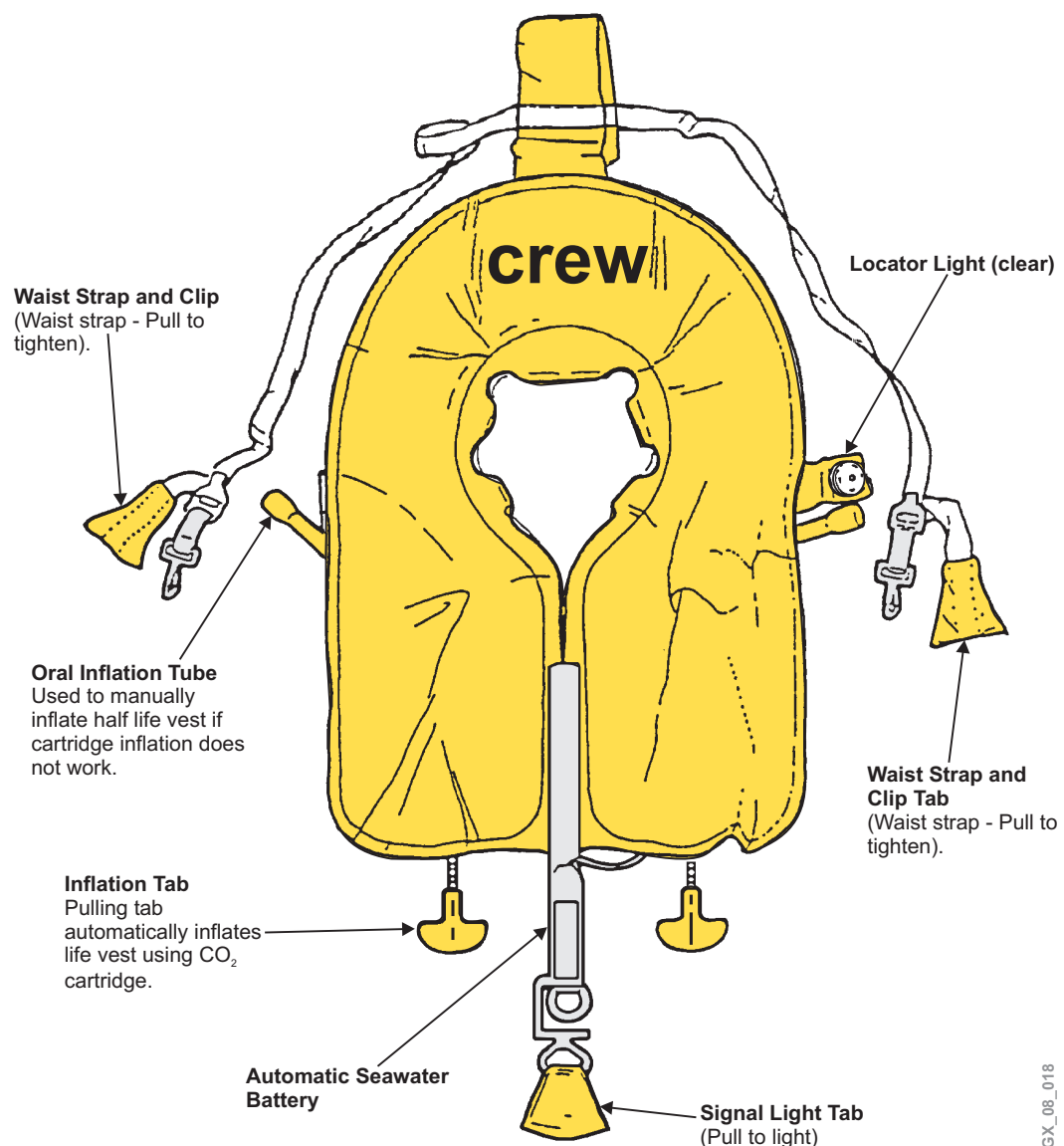

GX_08_018

LIFE VEST

To don the life vest proceed as follows:



1. The passenger will find the life vest under the seat



2. Put the life vest over head...

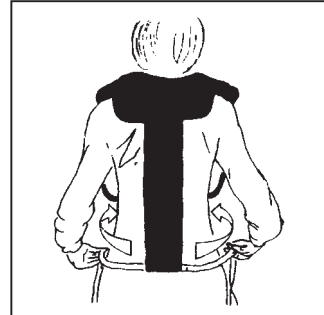

3. ...with the back piece behind.

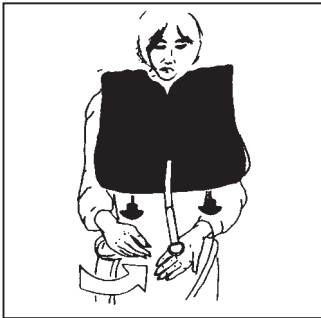

4. Fasten rings to catch

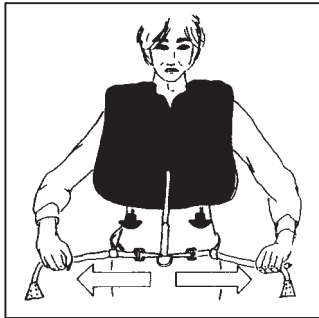

5. Pull straps tight



6. Jerk down on inflation tabs.



7. Should it become necessary, life vest can be orally inflated by blowing into oral inflation tubes.

**INFLATE LIFE VEST JUST PRIOR TO EXITING THE AIRPLANE.
WHEN USING OVERWING EMERGENCY EXIT
INFLATE LIFE VEST ONCE ON THE WING.**

NOTE

When using the adult/child life vest for children, pass straps between legs, fasten hooks. Inflate only one chamber.

GX_08_019

EMS CIRCUIT PROTECTION

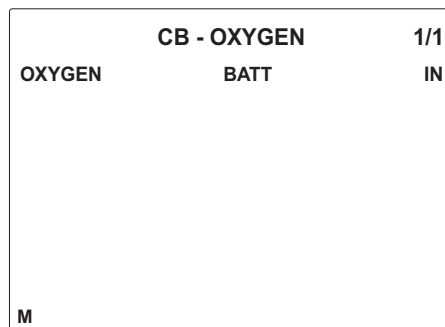
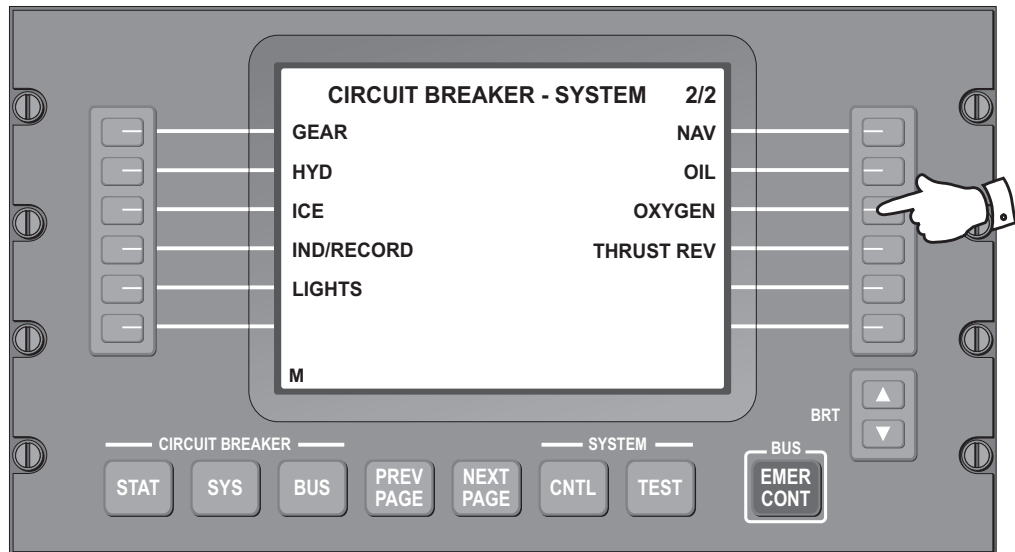

PAGE INTENTIONALLY LEFT BLANK